

**Trinkwasserinstallation  
Flächenheizung/-kühlung  
Nahwärmeversorgung**

**uponor**

**Kurzpreisliste 2024  
Deutschland**



# Uponor Kurzpreisliste Deutschland 2024

## Installationssysteme

### Verbundrohre und Fittingsysteme

Uponor Uni Pipe PLUS.....	6
Uponor S-Press PLUS PPSU.....	7
Uponor S-Press PLUS 14 mm.....	8
Uponor S-Press PLUS.....	9
Uponor S-Press PLUS Systemübergänge.....	13
Uponor S-Press PLUS Ventile.....	14
Uponor S-Press PLUS Heizung.....	15
Uponor RS.....	17

## Heizen/Kühlen

### Systeme zur Flächenheizung/-kühlung über Boden, Wand und Decke

Übersicht Uponor Flächenheizungssysteme.....	18
Übersicht Uponor Heizrohre.....	20
Uponor Minitec.....	22
Uponor Tecto.....	23
Uponor Nubos.....	24
Uponor Klett.....	25
Uponor Tacker.....	26
Uponor Classic.....	27
Uponor Siccus Mini.....	28
Uponor Siccus 14.....	29
Uponor Renovis.....	30
Uponor Teporis.....	31
Uponor Thermatop Deckensystem.....	32
Uponor Siccus Wall.....	33
Uponor Fix.....	34
Uponor Multi – Zubehör Fußbodenaufbau.....	35
Verteil und Steigleitungen > 20 mm.....	36

### Heizkreisverteiler und -zubehör

Übersicht Uponor Stellantriebe.....	37
Uponor Vario PLUS.....	38
Uponor Vario S.....	39
Uponor Vario M.....	41
Uponor Vario Verteilerzubehör.....	43

### Regelungstechnik

Übersicht Regelungstechnik Uponor Smatrix.....	44
--	----

### Vorlauftemperaturregelung

Uponor Fluvia Pumpengruppen.....	44
----------------------------------	----

### Raumtemperaturregelung

Uponor Smatrix Wave / Pulse.....	48
Uponor Smatrix Base / Pulse.....	49
Uponor Smatrix Base PRO.....	51
Uponor Base.....	53
Uponor Space.....	54

### Wohnungsstationen / Frischwasserstationen

Link zur Preisliste.....	56
--------------------------	----

## Nahwärmeversorgung

Übersicht Uponor Ecoflex Nahwärmeversorgung.....	58
Flexible, vorgedämmte Rohrsysteme.....	62

### Uponor Ecoflex Verbindungstechnik und -zubehör

Uponor Wipex.....	65
Uponor Q&E.....	67
Uponor Ecoflex Systemzubehör.....	68

Uponor Ecoflex Mietwerkzeuge.....	70
-----------------------------------	----

## Uponor Werkzeuge

Werkzeuge.....	71
----------------	----

## Anhang

Allgemeine Liefer- und Zahlungsbedingungen der Uponor GmbH.....	77
--	----

# Uponor Kurzpreisliste Deutschland 2024

## Installationssysteme

Trinkwasser- und Heizungsinstallation Uponor Verbundrohrsysteme . . . . .	6
--	---

Installation

## Flächenheizung/-kühlung

Flächenheizung/-kühlung über Boden, Wand und Decke . . . . .	18
Verteiler und -zubehör . . . . .	37
Pumpengruppen . . . . .	44
Raumtemperaturregelung . . . . .	46

Flächenheizung  
und -kühlung

## Nahwärmeversorgung

Flexible vorgedämmte Rohrleitungen, Verbindungstechniken und Systemzubehör für erdverlegte Nahwärmenetze . . . . .	58
--	----

Nahwärme-  
versorgung

## Werkzeuge

Werkzeuge für die Verarbeitung von Installationsrohren und Rohren in der Flächenheizung/-kühlung . . . . .	71
---	----

Werkzeuge

## Anhang

Allgemeine Geschäftsbedingungen . . . . .	77
---	----

Anhang

# Installationsrohre und Verbindungstechnik

Unterschiedliche Montagesituationen und Einsatzbereiche verlangen nach perfekt darauf abgestimmten Fittingkonzepten. Deshalb entwickelt und produziert Uponor nicht nur Rohre, sondern gleichzeitig auch die passenden, auf den jeweiligen Einsatz zugeschnittenen Fittingsysteme. Das Uponor Fittingprogramm mit Kupplungen, Winkeln, T-Stücken und einer Vielzahl von praxismgerechten Systemkomponenten schafft die Voraussetzung für eine schnelle, sichere und praxismgerechte Montage und übertrifft dabei die Anforderungen, die an hygienische Trinkwasser-Installationen und zeitgemäße Heizungsverrohrungen gestellt werden.

## Uponor Fittingsystem

Dimension/ Farbcode	Verbund- rohrtyp
------------------------	---------------------

 14	MLC
--	-----

 16	Uni Pipe PLUS
--	---------------

 20	Uni Pipe PLUS
--	---------------

 25	Uni Pipe PLUS
--	---------------

 32	Uni Pipe PLUS
--	---------------

 40	MLC
--	-----

 50	MLC
--	-----

 63	MLC
--	-----

 75	MLC
--	-----

 90	MLC
--	-----

 110	MLC
---	-----

## Eigenschaften

Dimensionsabhängige Farbcodierung

Sichtfenster zur Kontrolle der Einstecktiefe

Verpresstkennzeichnung  
durch Ablösen der Folie von der Presshülse

Verpresstkennzeichnung  
durch Ablösung des Anschlagringes

Verpresstkennzeichnung  
durch Pressabdruck auf Presshülse









Montage ohne Entgraten

Montage ohne Kalibrieren

Verbinder unverpresst undicht

Integrierte Pressfunktion

Modulares Fittingsystem

Press-Fitting, Metall				Press-Fitting, Verbund			Uni-C 1/2"	Uni-X 3/4"
S-Press PLUS	S-Press		RS	S-Press PLUS, PPSU	S-Press PPSU			
								
		•				•	•	
•	•		•	•		•	•	
•			•	•		•	•	
•			•	•			•	
•			•	•				
		•	•		•			
		•	•		•			
		•	•		•			
			•					
			•					
			•					
•	•	•	•	•	•			
•	•	•	•	•	•			
•			• <sup>2)</sup>	•				
	•		• <sup>3)</sup>					
•		•	• <sup>2)</sup>	•	•			
•	•		• <sup>1)</sup>	•		•	•	
•	•	•	•	•	•	•	•	
•	•	•	•	•	•			
			•					

<sup>1)</sup> bis Dimension 32  
<sup>2)</sup> ab Dimension 20  
<sup>3)</sup> Dimension 16

# Uponor Uni Pipe PLUS

Art-Nr.	Dimension	LE	VE	ME RG	Preis/ME
---------	-----------	----	----	----------	----------

## Uponor Uni Pipe PLUS weiß S

 <b>1060783</b>	16x2,0 3m	75	3	$\frac{m}{E1}$	<b>8,34</b>
<b>1059572</b>	16x2,0 5m	125	5	$\frac{m}{E1}$	<b>7,92</b>
<b>1060784</b>	20x2,25 3m	51	3	$\frac{m}{E1}$	<b>10,76</b>
<b>1059573</b>	20x2,25 5m	85	5	$\frac{m}{E1}$	<b>10,25</b>
<b>1060785</b>	25x2,5 3m	30	3	$\frac{m}{E1}$	<b>15,71</b>
<b>1059574</b>	25x2,5 5m	50	5	$\frac{m}{E1}$	<b>15,15</b>
<b>1060786</b>	32x3,0 3m	21	3	$\frac{m}{E1}$	<b>22,49</b>
<b>1059575</b>	32x3,0 5m	35	5	$\frac{m}{E1}$	<b>21,52</b>

## Uponor MLC Rohr weiß S

 <b>1013448</b>	40x4,0 3m	12	3	$\frac{m}{E1}$	<b>41,87</b>
<b>1013446</b>	40x4,0 5m	20	5	$\frac{m}{E1}$	<b>41,15</b>
<b>1021980</b>	50x4,5 3m	12	3	$\frac{m}{E1}$	<b>59,38</b>
<b>1013449</b>	50x4,5 5m	20	5	$\frac{m}{E1}$	<b>58,73</b>
<b>1021981</b>	63x6,0 3m	9	3	$\frac{m}{E1}$	<b>75,30</b>
<b>1013451</b>	63x6,0 5m	15	5	$\frac{m}{E1}$	<b>73,50</b>
<b>1013453</b>	75x7,5 5m	255	5	$\frac{m}{E1}$	<b>118,96</b>
<b>1013455</b>	90x8,5 5m	255	5	$\frac{m}{E1}$	<b>129,61</b>
<b>1013457</b>	110x10,0 5m	165	5	$\frac{m}{E1}$	<b>154,32</b>

## Uponor Uni Pipe PLUS weiß

 <b>1059576</b>	16x2,0 100m	2000	100	$\frac{m}{E1}$	<b>4,02</b>
<b>1092653</b>	16x2,0 120m	2400	120	$\frac{m}{E1}$	<b>4,02</b>
<b>1059577</b>	16x2,0 200m	2600	200	$\frac{m}{E1}$	<b>4,02</b>
<b>1059578</b>	16x2,0 500m	3500	500	$\frac{m}{E1}$	<b>4,02</b>
<b>1059579</b>	20x2,25 100m	1300	100	$\frac{m}{E1}$	<b>7,19</b>
<b>1093124</b>	20x2,25 500m	2000	500	$\frac{m}{E1}$	<b>7,19</b>
<b>1059581</b>	25x2,5 50m	700	50	$\frac{m}{E1}$	<b>14,93</b>
<b>1059583</b>	32x3,0 50m	400	50	$\frac{m}{E1}$	<b>21,01</b>

## Uponor MLC Rohr weiß

 <b>1013366</b>	14x2,0 200m	2600	200	$\frac{m}{E1}$	<b>4,20</b>
--	-------------	------	-----	----------------	-------------

## Uponor Uni Pipe PLUS weiß vorgedämmt S4 WLS 040

 <b>1091709</b>	16x2,0 red 100m	800	100	$\frac{m}{E1}$	<b>7,19</b>
<b>1063553</b>	16x2,0 blue 100m	800	100	$\frac{m}{E1}$	<b>7,19</b>
<b>1091710</b>	20x2,25 red 100m	800	100	$\frac{m}{E1}$	<b>9,59</b>
<b>1063555</b>	20x2,25 blue 100m	800	100	$\frac{m}{E1}$	<b>9,59</b>
<b>1091711</b>	25x2,5 red 50m	400	50	$\frac{m}{E1}$	<b>23,62</b>
<b>1063946</b>	25x2,5 blue 50m	400	50	$\frac{m}{E1}$	<b>23,62</b>
<b>1091712</b>	32x3,0 red 50m	350	50	$\frac{m}{E1}$	<b>32,47</b>
<b>1091716</b>	32x3,0 blue 50m	350	50	$\frac{m}{E1}$	<b>32,47</b>

## Uponor Uni Pipe PLUS weiß vorgedämmt S6 WLS 035

 <b>1063556</b>	16x2,0 blue 75m	600	75	$\frac{m}{E1}$	<b>7,54</b>
<b>1063557</b>	20x2,25 blue 75m	600	75	$\frac{m}{E1}$	<b>9,32</b>
<b>1063558</b>	25x2,5 blue 50m	400	50	$\frac{m}{E1}$	<b>22,07</b>

Art-Nr.	Dimension	LE	VE	ME RG	Preis/ME
---------	-----------	----	----	----------	----------

## Uponor Uni Pipe PLUS weiß vorgedämmt S10 WLS 035

 <b>1062181</b>	16x2,0 blue 75m	450	75	$\frac{m}{E1}$	<b>8,30</b>
<b>1062182</b>	20x2,25 blue 75m	525	75	$\frac{m}{E1}$	<b>10,75</b>
<b>1062183</b>	25x2,5 blue 50m	350	50	$\frac{m}{E1}$	<b>23,78</b>

## Uponor Uni Pipe PLUS weiß vorgedämmt DHS9

 <b>1063559</b>	16x2,0 blue 75m	525	75	$\frac{m}{E1}$	<b>9,23</b>
<b>1063560</b>	20x2,25 blue 75m	525	75	$\frac{m}{E1}$	<b>11,61</b>

## Uponor Uni Pipe PLUS weiß vorgedämmt DHS26

 <b>1063561</b>	16x2,0 blue 25m	200	25	$\frac{m}{E1}$	<b>16,23</b>
<b>1063562</b>	20x2,25 blue 25m	200	25	$\frac{m}{E1}$	<b>18,66</b>

## Uponor Uni Pipe PLUS weiß im Schutzrohr

 <b>1063061</b>	16x2,0 - 25/20 red 75m	1125	75	$\frac{m}{E1}$	<b>7,36</b>
<b>1063059</b>	16x2,0 - 25/20 blue 75m	1125	75	$\frac{m}{E1}$	<b>7,36</b>
<b>1063062</b>	20x2,25 - 28/23 red 75m	900	75	$\frac{m}{E1}$	<b>11,38</b>
<b>1063060</b>	20x2,25 - 28/23 blue 75m	900	75	$\frac{m}{E1}$	<b>11,38</b>

## Uponor Teck Schutzrohr black

 <b>1012860</b>	25/20 50m	2500	50	$\frac{m}{EZ}$	<b>2,29</b>
<b>1012864</b>	28/23 50m	2000	50	$\frac{m}{EZ}$	<b>2,37</b>
<b>1012869</b>	35/29 50m	1400	50	$\frac{m}{EZ}$	<b>4,10</b>
<b>1012872</b>	43/36 25m	600	25	$\frac{m}{EZ}$	<b>6,01</b>

## Uponor Teck Schutzrohr blue

 <b>1012859</b>	25/20 50m	2500	50	$\frac{m}{EZ}$	<b>2,29</b>
<b>1012863</b>	28/23 50m	2000	50	$\frac{m}{EZ}$	<b>2,37</b>

## Uponor Teck Schutzrohr red

 <b>1012858</b>	25/20 50m	2500	50	$\frac{m}{EZ}$	<b>2,29</b>
<b>1012862</b>	28/23 50m	2000	50	$\frac{m}{EZ}$	<b>2,37</b>

## Uponor Teck Dübelhaken einfach

 <b>1135511</b>	75	1600	200	$\frac{St.}{D1}$	<b>1,01</b>
<b>1135512</b>	90	1600	200	$\frac{St.}{D1}$	<b>1,01</b>

## Uponor Teck Dübelhaken doppelt

 <b>1135513</b>	75	1200	200	$\frac{St.}{D1}$	<b>1,34</b>
<b>1135514</b>	90	800	200	$\frac{St.}{D1}$	<b>1,34</b>

# Uponor S-Press PLUS PPSU

Art-Nr.	Dimension	LE	VE	ME RG	Preis/ME
 <b>1039929</b>	16-16	80	20	St. E1	<b>9,37</b>
<b>1039930</b>	20-20	80	10	St. E1	<b>12,22</b>
<b>1039931</b>	25-25	80	10	St. E1	<b>22,08</b>
<b>1039932</b>	32-32	20	5	St. E1	<b>30,39</b>

## Uponor S-Press Verbund Winkel PPSU

 <b>1046386</b>	40-40	960	5	St. E1	<b>62,22</b>
<b>1046387</b>	50-50	576	3	St. E1	<b>80,15</b>
<b>1032877</b>	63-63	210	1	St. E1	<b>148,32</b>
<b>1032878</b>	75-75	210	1	St. E1	<b>227,82</b>

## Uponor S-Press Verbund Winkel 45° PPSU

 <b>1046388</b>	40-40	960	5	St. E1	<b>62,17</b>
<b>1046389</b>	50-50	576	3	St. E1	<b>85,29</b>
<b>1032879</b>	63-63	192	1	St. E1	<b>156,47</b>
<b>1032880</b>	75-75	192	1	St. E1	<b>212,86</b>

## Uponor S-Press PLUS Kupplung PPSU

 <b>1039933</b>	16-16	80	20	St. E1	<b>7,56</b>
<b>1039934</b>	20-20	80	10	St. E1	<b>10,34</b>
<b>1039935</b>	25-25	80	10	St. E1	<b>15,32</b>
<b>1039936</b>	32-32	80	10	St. E1	<b>22,51</b>

## Uponor S-Press Verbund Kupplung PPSU

 <b>1046401</b>	40-40	960	5	St. E1	<b>43,51</b>
<b>1046402</b>	50-50	576	3	St. E1	<b>57,65</b>
<b>1032881</b>	63-63	384	1	St. E1	<b>108,12</b>
<b>1032882</b>	75-75	384	1	St. E1	<b>174,92</b>

## Uponor S-Press PLUS Kupplung reduziert PPSU

 <b>1039937</b>	20-16	80	20	St. E1	<b>10,54</b>
<b>1039938</b>	25-16	80	10	St. E1	<b>14,30</b>
<b>1039939</b>	25-20	80	10	St. E1	<b>14,30</b>
<b>1039940</b>	32-25	80	10	St. E1	<b>23,04</b>

## Uponor S-Press Verbund Kupplung red. PPSU

 <b>1046406</b>	50-40	576	3	St. E1	<b>58,22</b>
<b>1032883</b>	63-40	384	1	St. E1	<b>100,40</b>
<b>1032884</b>	63-50	384	1	St. E1	<b>102,54</b>
<b>1032885</b>	75-50	384	1	St. E1	<b>147,54</b>
<b>1032886</b>	75-63	384	1	St. E1	<b>163,15</b>

## Uponor S-Press Kupplung reduziert PPSU

 <b>1039941</b>	40-25	960	5	St. E1	<b>40,64</b>
<b>1039942</b>	40-32	960	5	St. E1	<b>40,64</b>
<b>1039943</b>	50-32	1152	3	St. E1	<b>52,96</b>

Art-Nr.	Dimension	LE	VE	ME RG	Preis/ME
 <b>1039944</b>	16-16-16	80	10	St. E1	<b>14,65</b>
<b>1039945</b>	20-20-20	80	10	St. E1	<b>20,91</b>
<b>1039946</b>	25-25-25	20	5	St. E1	<b>25,09</b>
<b>1039947</b>	32-32-32	20	5	St. E1	<b>41,20</b>

## Uponor S-Press Verbund T-Stück PPSU

 <b>1046390</b>	40-40-40	720	5	St. E1	<b>89,66</b>
<b>1046391</b>	50-50-50	288	3	St. E1	<b>106,05</b>
<b>1032887</b>	63-63-63	150	1	St. E1	<b>188,65</b>
<b>1032888</b>	75-75-75	150	1	St. E1	<b>297,32</b>

## Uponor S-Press PLUS T-Stück reduziert PPSU

 <b>1039948</b>	16-20-16	80	10	St. E1	<b>20,91</b>
<b>1039949</b>	20-16-16	80	10	St. E1	<b>20,91</b>
<b>1039950</b>	20-16-20	80	10	St. E1	<b>20,92</b>
<b>1039951</b>	20-20-16	80	10	St. E1	<b>20,91</b>
<b>1039952</b>	20-25-20	80	10	St. E1	<b>27,36</b>
<b>1039953</b>	25-16-16	80	10	St. E1	<b>27,36</b>
<b>1039954</b>	25-16-20	80	10	St. E1	<b>27,36</b>
<b>1039955</b>	25-16-25	80	10	St. E1	<b>27,36</b>
<b>1039956</b>	25-20-20	80	10	St. E1	<b>27,36</b>
<b>1039957</b>	25-20-25	80	10	St. E1	<b>27,36</b>
<b>1039958</b>	32-16-32	20	5	St. E1	<b>44,24</b>
<b>1039959</b>	32-20-32	20	5	St. E1	<b>44,24</b>
<b>1039960</b>	32-25-25	20	5	St. E1	<b>44,24</b>
<b>1039961</b>	32-25-32	20	5	St. E1	<b>44,24</b>







## Uponor S-Press T-Stück reduziert PPSU





 <b>1039962</b>	40-20-40	960	5	St. E1	<b>80,03</b>
<b>1039963</b>	40-25-32	960	5	St. E1	<b>80,03</b>
<b>1039964</b>	40-25-40	720	5	St. E1	<b>80,03</b>
<b>1039965</b>	40-32-32	960	5	St. E1	<b>80,03</b>
<b>1039966</b>	40-32-40	720	5	St. E1	<b>80,03</b>
<b>1039967</b>	50-25-40	432	3	St. E1	<b>92,96</b>
<b>1039968</b>	50-25-50	432	3	St. E1	<b>92,96</b>
<b>1039969</b>	50-32-50	432	3	St. E1	<b>92,96</b>

## Uponor S-Press Verbund T-Stück reduziert PPSU

 <b>1046400</b>	50-40-50	288	3	St. E1	<b>102,36</b>
<b>1032889</b>	63-25-63	150	1	St. E1	<b>171,46</b>
<b>1032890</b>	63-32-63	150	1	St. E1	<b>177,06</b>
<b>1032891</b>	63-40-63	150	1	St. E1	<b>177,06</b>
<b>1032892</b>	75-32-75	150	1	St. E1	<b>223,93</b>
<b>1032893</b>	75-40-75	150	1	St. E1	<b>258,75</b>
<b>1032894</b>	75-50-75	150	1	St. E1	<b>258,75</b>

# Uponor S-Press PLUS 14 mm

Art-Nr.	Dimension	LE	VE	ME RG	Preis/ME
<b>Uponor S-Press Übergangsnippel</b>					
 <b>1014513</b>	14-R $\frac{1}{2}$ "MT	80	20	St. E1	<b>13,63</b>
<b>Uponor S-Press Übergangsmuffe</b>					
 <b>1014515</b>	14-Rp $\frac{1}{2}$ "FT	80	20	St. E1	<b>18,10</b>
<b>Uponor S-Press Winkel</b>					
 <b>1133445</b>	14-14	80	20	St. E1	<b>17,32</b>
<b>Uponor S-Press Kupplung</b>					
 <b>1015154</b>	14-14	80	10	St. D1	<b>15,00</b>
<b>Uponor S-Press Kupplung reduziert</b>					
 <b>1015162</b>	16-14	80	20	St. E1	<b>14,46</b>
<b>Uponor S-Press T-Stück</b>					
 <b>1014886</b>	14-14-14	80	10	St. E1	<b>23,86</b>
<b>Uponor S-Press T-Stück reduziert</b>					
 <b>1014888</b>	14-16-14	80	10	St. E1	<b>31,80</b>
<b>1014912</b>	16-14-14	80	10	St. E1	<b>31,80</b>
<b>1014915</b>	16-14-16	80	10	St. E1	<b>31,80</b>

Art-Nr.	Dimension	LE	VE	ME RG	Preis/ME
<b>Uponor S-Press Übergang auf Kupfer</b>					
 <b>1014511</b>	14-15CU	80	10	St. E1	<b>35,34</b>
<b>Uponor Smart Aqua Wandscheibe S-Press</b>					
 <b>1015437</b>	14-Rp $\frac{1}{2}$ "FT	40	10	St. E1	<b>28,83</b>
<b>Uponor S-Press Doppel-Wands. 90° long</b>					
 <b>1133446</b>	14-Rp $\frac{1}{2}$ "FT-14	40	10	St. E1	<b>52,52</b>
<b>Uponor Smart Radi Anschlusswinkel S-Press</b>					
 <b>1015615</b>	14-15CU l=350mm	-	20	St. E2	<b>30,46</b>



# Uponor S-Press PLUS

Art-Nr.	Dimension	LE	VE	ME RG	Preis/ME
---------	-----------	----	----	----------	----------

## Uponor S-Press PLUS Übergangsnippel

	<b>1070502</b> 16-R½"MT	80	20	St. E1	<b>11,85</b>
	<b>1070503</b> 16-R¾"MT	120	15	St. E1	<b>15,72</b>
	<b>1070504</b> 20-R½"MT	80	20	St. E1	<b>17,92</b>
	<b>1070505</b> 20-R¾"MT	80	10	St. E1	<b>17,92</b>
	<b>1070506</b> 20-R1"MT	80	10	St. E1	<b>25,22</b>
	<b>1070507</b> 25-R¾"MT	80	10	St. E1	<b>24,35</b>
	<b>1070508</b> 25-R1"MT	40	5	St. E1	<b>28,77</b>
	<b>1070509</b> 32-R1"MT	40	5	St. E1	<b>31,67</b>
	<b>1070510</b> 32-R1 ¼"MT	20	5	St. E1	<b>41,04</b>

## Uponor S-Press Übergangsnippel

	<b>1046901</b> 40-R1 ¼"MT	960	5	St. E1	<b>51,29</b>
	<b>1046902</b> 40-R1 ½"MT	960	5	St. E1	<b>56,71</b>
	<b>1046905</b> 50-R1 ½"MT	1152	3	St. E1	<b>85,08</b>
	<b>1046906</b> 50-R2"MT	576	3	St. E1	<b>109,33</b>
	<b>1032895</b> 63-R2"MT	336	1	St. E1	<b>155,25</b>
	<b>1032896</b> 75-R2 ½"MT	336	1	St. E1	<b>204,66</b>

## Uponor S-Press PLUS Übergangsmuffe

	<b>1070515</b> 16-Rp½"FT	80	20	St. E1	<b>14,04</b>
	<b>1070516</b> 20-Rp½"FT	120	15	St. E1	<b>21,03</b>
	<b>1070517</b> 20-Rp¾"FT	80	10	St. E1	<b>21,03</b>
	<b>1070518</b> 20-Rp1"FT	80	20	St. E1	<b>29,19</b>
	<b>1070519</b> 25-Rp¾"FT	40	5	St. E1	<b>28,31</b>
	<b>1070520</b> 25-Rp1"FT	40	5	St. E1	<b>29,81</b>
	<b>1070521</b> 32-Rp1"FT	40	5	St. E1	<b>34,66</b>
	<b>1070522</b> 32-Rp1 ¼"FT	20	5	St. E1	<b>42,77</b>

## Uponor S-Press Übergangsmuffe

	<b>1046903</b> 40-Rp1 ¼"FT	960	5	St. E1	<b>53,36</b>
	<b>1046904</b> 40-Rp1 ½"FT	960	5	St. E1	<b>53,92</b>
	<b>1046907</b> 50-Rp1 ½"FT	1152	3	St. E1	<b>130,02</b>

## Uponor S-Press PLUS Winkel

	<b>1070523</b> 16-16	80	20	St. E1	<b>14,08</b>
	<b>1070524</b> 20-20	80	10	St. E1	<b>18,95</b>
	<b>1070525</b> 25-25	40	5	St. E1	<b>27,61</b>
	<b>1070526</b> 32-32	20	5	St. E1	<b>41,86</b>

## Uponor S-Press Winkel

	<b>1046908</b> 40-40	600	5	St. E1	<b>62,95</b>
	<b>1046911</b> 50-50	240	3	St. E1	<b>83,51</b>

Art-Nr.	Dimension	LE	VE	ME RG	Preis/ME
---------	-----------	----	----	----------	----------

## Uponor S-Press PLUS Bogen

	<b>1070527</b> 16-16	80	10	St. E1	<b>20,15</b>
	<b>1070528</b> 20-20	80	10	St. E1	<b>23,79</b>
	<b>1070529</b> 25-25	40	5	St. E1	<b>34,71</b>
	<b>1070530</b> 32-32	20	5	St. E1	<b>43,94</b>

## Uponor S-Press PLUS Winkelnippel

	<b>1070532</b> 16-R½"MT	80	20	St. E1	<b>16,93</b>
	<b>1070533</b> 20-R½"MT	80	10	St. E1	<b>29,37</b>
	<b>1070534</b> 20-R¾"MT	80	10	St. E1	<b>37,92</b>
	<b>1070535</b> 25-R¾"MT	40	5	St. E1	<b>36,75</b>
	<b>1070536</b> 25-R1"MT	40	5	St. E1	<b>45,05</b>
	<b>1070537</b> 32-R1"MT	20	5	St. E1	<b>55,51</b>

## Uponor S-Press Winkelnippel

	<b>1046909</b> 40-R1 ¼"MT	500	5	St. E1	<b>94,86</b>
---	---------------------------	-----	---	-----------	--------------

## Uponor S-Press PLUS Winkelmuffe

	<b>1070539</b> 16-Rp½"FT	80	10	St. E1	<b>19,71</b>
	<b>1070540</b> 20-Rp½"FT	80	10	St. E1	<b>33,35</b>
	<b>1070541</b> 20-Rp¾"FT	40	10	St. E1	<b>34,86</b>
	<b>1070542</b> 25-Rp¾"FT	20	5	St. E1	<b>43,09</b>
	<b>1070543</b> 25-Rp1"FT	20	5	St. E1	<b>53,17</b>
	<b>1070544</b> 32-Rp1"FT	20	5	St. E1	<b>67,87</b>

## Uponor S-Press Winkelmuffe

	<b>1046910</b> 40-Rp1 ½"FT	500	5	St. E1	<b>96,33</b>
	<b>1046912</b> 50-Rp1 ½"FT	300	3	St. E1	<b>112,87</b>

## Uponor S-Press PLUS Winkel 45°

	<b>1070545</b> 25-25	20	5	St. E1	<b>41,86</b>
	<b>1070546</b> 32-32	20	5	St. E1	<b>70,81</b>

## Uponor S-Press Winkel 45°

	<b>1046913</b> 40-40	500	5	St. E1	<b>72,99</b>
	<b>1046914</b> 50-50	300	3	St. E1	<b>100,41</b>

## Uponor S-Press PLUS Kupplung

	<b>1070547</b> 16-16	80	20	St. D1	<b>12,03</b>
	<b>1070548</b> 20-20	80	10	St. E1	<b>15,01</b>
	<b>1070549</b> 25-25	80	10	St. E1	<b>22,95</b>
	<b>1070550</b> 32-32	40	5	St. E1	<b>28,20</b>

# Uponor S-Press PLUS

Art-Nr.	Dimension	LE	VE	ME RG	Preis/ME
<b>Uponor S-Press PLUS Schiebekupplung</b>					
 <b>1118706</b>	16-16	80	10	St. E1	<b>74,51</b>
<b>1118707</b>	20-20	80	10	St. E1	<b>86,96</b>
<b>1118708</b>	25-25	40	5	St. E1	<b>103,77</b>
<b>1118709</b>	32-32	20	5	St. E1	<b>112,63</b>

## Uponor S-Press Schiebekupplung

 <b>1118710</b>	40-40	12	3	St. E1	<b>186,53</b>
--	-------	----	---	-----------	---------------

## Uponor S-Press Kupplung

 <b>1046932</b>	40-40	960	5	St. E1	<b>49,19</b>
<b>1046935</b>	50-50	576	3	St. E1	<b>63,74</b>

## Uponor S-Press PLUS Kupplung reduziert

 <b>1070552</b>	20-16	80	20	St. E1	<b>14,77</b>
<b>1070553</b>	25-16	80	10	St. E1	<b>22,59</b>
<b>1070554</b>	25-20	80	10	St. E1	<b>22,89</b>
<b>1070555</b>	32-20	80	10	St. E1	<b>28,56</b>
<b>1070556</b>	32-25	80	10	St. E1	<b>30,11</b>

## Uponor S-Press Kupplung reduziert

 <b>1046930</b>	40-25	960	5	St. E1	<b>46,85</b>
<b>1046931</b>	40-32	960	5	St. E1	<b>47,42</b>
<b>1046933</b>	50-32	1152	3	St. E1	<b>55,56</b>
<b>1046934</b>	50-40	576	3	St. E1	<b>56,59</b>

## Uponor S-Press PLUS T-Stück

 <b>1070560</b>	16-16-16	80	10	St. E1	<b>18,75</b>
<b>1070561</b>	20-20-20	80	10	St. E1	<b>25,26</b>
<b>1070562</b>	25-25-25	20	5	St. E1	<b>36,75</b>
<b>1070563</b>	32-32-32	20	5	St. E1	<b>61,44</b>

## Uponor S-Press T-Stück

 <b>1046921</b>	40-40-40	400	5	St. E1	<b>86,00</b>
<b>1046928</b>	50-50-50	300	3	St. E1	<b>113,02</b>

Art-Nr.	Dimension	LE	VE	ME RG	Preis/ME
<b>Uponor S-Press PLUS T-Stück reduziert</b>					
 <b>1070566</b>	16-20-16	80	10	St. E1	<b>26,66</b>
<b>1070567</b>	20-16-16	40	10	St. E1	<b>26,66</b>
<b>1070568</b>	20-16-20	80	20	St. E1	<b>25,79</b>
<b>1070569</b>	20-20-16	80	20	St. E1	<b>25,79</b>
<b>1070570</b>	20-25-16	40	10	St. E1	<b>36,10</b>
<b>1070571</b>	20-25-20	40	10	St. E1	<b>36,10</b>
<b>1070572</b>	25-16-16	40	5	St. E1	<b>36,10</b>
<b>1070573</b>	25-16-20	40	5	St. E1	<b>36,10</b>
<b>1070574</b>	25-16-25	20	5	St. E1	<b>36,10</b>
<b>1070575</b>	25-20-16	40	5	St. E1	<b>36,10</b>
<b>1070576</b>	25-20-20	40	5	St. E1	<b>36,10</b>
<b>1070577</b>	25-20-25	20	5	St. E1	<b>36,10</b>
<b>1070578</b>	25-25-16	20	5	St. E1	<b>36,10</b>
<b>1070579</b>	25-32-25	20	5	St. E1	<b>68,71</b>
<b>1070580</b>	32-16-32	20	5	St. E1	<b>68,71</b>
<b>1070581</b>	32-20-32	20	5	St. E1	<b>68,71</b>
<b>1070582</b>	32-25-25	20	5	St. E1	<b>68,71</b>
<b>1070583</b>	32-25-32	20	5	St. E1	<b>68,71</b>

## Uponor S-Press T-Stück reduziert

 <b>1046916</b>	40-20-40	400	5	St. E1	<b>83,85</b>
<b>1046917</b>	40-25-32	500	5	St. E1	<b>74,74</b>
<b>1046918</b>	40-25-40	400	5	St. E1	<b>83,85</b>
<b>1046919</b>	40-32-32	400	5	St. E1	<b>76,91</b>
<b>1046920</b>	40-32-40	400	5	St. E1	<b>83,85</b>
<b>1046924</b>	50-25-40	300	3	St. E1	<b>112,25</b>
<b>1046925</b>	50-25-50	240	3	St. E1	<b>118,69</b>
<b>1046926</b>	50-32-50	300	3	St. E1	<b>118,70</b>
<b>1046927</b>	50-40-50	300	3	St. E1	<b>120,38</b>

## Uponor S-Press PLUS T-Stück m. Aussengew.

 <b>1070592</b>	16-R $\frac{1}{2}$ "MT-16	40	10	St. E1	<b>42,50</b>
<b>1070593</b>	25-R $\frac{3}{4}$ "MT-25	20	5	St. E1	<b>54,65</b>
<b>1070594</b>	32-R $\frac{3}{4}$ "MT-32	20	5	St. E1	<b>67,48</b>

## Uponor S-Press PLUS T-Stück m. Innengew.

 <b>1070595</b>	16-Rp $\frac{1}{2}$ "FT-16	40	10	St. E1	<b>36,91</b>
<b>1070596</b>	20-Rp $\frac{1}{2}$ "FT-20	60	15	St. E1	<b>41,72</b>
<b>1070597</b>	20-Rp $\frac{3}{4}$ "FT-20	40	10	St. E1	<b>44,40</b>
<b>1070598</b>	25-Rp $\frac{1}{2}$ "FT-25	20	5	St. E1	<b>47,18</b>
<b>1070599</b>	25-Rp $\frac{3}{4}$ "FT-25	20	5	St. E1	<b>51,30</b>
<b>1070600</b>	32-Rp $\frac{1}{2}$ "FT-32	20	5	St. E1	<b>67,60</b>
<b>1070601</b>	32-Rp $\frac{3}{4}$ "FT-32	20	5	St. E1	<b>67,60</b>

# Uponor S-Press PLUS

Art-Nr.	Dimension	LE	VE	ME RG	Preis/ME
 <b>1046922</b>	40-Rp½"FT-40	500	5	St. E1	<b>78,65</b>
<b>1046923</b>	40-Rp¾"FT-40	400	5	St. E1	<b>78,65</b>
<b>1046929</b>	50-Rp1"FT-50	240	3	St. E1	<b>130,81</b>

## Uponor S-Press PLUS Verschraubung IG

 <b>1070602</b>	16-G½"SN	30	1	St. E1	<b>27,03</b>
<b>1070603</b>	16-G¾"SN	20	1	St. E1	<b>32,54</b>
<b>1070604</b>	20-G½"SN	20	1	St. E1	<b>29,67</b>
<b>1070605</b>	20-G¾"SN	20	1	St. E1	<b>36,44</b>
<b>1070606</b>	25-G¾"SN	15	1	St. E1	<b>41,35</b>
<b>1070607</b>	25-G1"SN	15	1	St. E1	<b>41,35</b>
<b>1070608</b>	25-G1 ¼"SN	10	1	St. E1	<b>47,49</b>
<b>1070609</b>	32-G1"SN	10	1	St. E1	<b>55,44</b>
<b>1070610</b>	32-G1 ¼"SN	10	1	St. E1	<b>48,48</b>

## Uponor S-Press Verschraubung IG

 <b>1060094</b>	40-G1 ¼"SN	960	5	St. E1	<b>103,57</b>
<b>1046937</b>	40-G1 ½"SN	960	5	St. E1	<b>80,45</b>
<b>1060095</b>	50-G1 ½"SN	1152	3	St. E1	<b>109,33</b>
<b>1046939</b>	50-G2"SN	576	3	St. E1	<b>92,20</b>

## Uponor S-Press PLUS Winkelverschraubg IG

 <b>1070611</b>	16-G¾"SN	20	1	St. E1	<b>29,63</b>
<b>1070612</b>	16-G½"SN	20	1	St. E1	<b>29,75</b>
<b>1105818</b>	16-G¾"SN	10	1	St. E1	<b>32,04</b>
<b>1070613</b>	20-G½"SN	20	1	St. E1	<b>35,66</b>
<b>1105819</b>	20-G¾"SN	10	1	St. E1	<b>33,48</b>
<b>1070614</b>	25-G¾"SN	10	1	St. E1	<b>38,53</b>

Art-Nr.	Dimension	LE	VE	ME RG	Preis/ME
 <b>1070638</b>	16-Rp¾"FT	40	10	St. E1	<b>28,23</b>
<b>1070639</b>	16-Rp½"FT	40	10	St. E1	<b>23,17</b>
<b>1070640</b>	20-Rp½"FT	40	10	St. E1	<b>28,23</b>
<b>1070641</b>	20-Rp¾"FT	20	5	St. E1	<b>30,72</b>
<b>1070642</b>	25-Rp¾"FT	20	5	St. E1	<b>38,34</b>

## Uponor S-Press PLUS Wandscheibe L

 <b>1070644</b>	16-Rp½"FT	40	10	St. E1	<b>31,70</b>
<b>1070645</b>	20-Rp½"FT	40	10	St. E1	<b>36,55</b>

## Uponor S-Press PLUS Wandscheibe XL

 <b>1070646</b>	16-Rp½"FT	40	10	St. E1	<b>38,70</b>
<b>1070647</b>	20-Rp½"FT	40	10	St. E1	<b>40,74</b>

## Uponor S-Press PLUS Schallset 2 Wandscheiben

 <b>1121193</b>	16-20	192	1	Set E1	<b>43,71</b>
--	-------	-----	---	-----------	--------------

## Uponor S-Press PLUS U-Wandscheibe

 <b>1070629</b>	16-Rp½"FT-16	20	5	St. E1	<b>57,63</b>
<b>1070630</b>	20-Rp½"FT-20	960	5	St. E1	<b>71,69</b>
<b>1070631</b>	20-Rp½"FT-16	960	5	St. E1	<b>80,53</b>
<b>1070632</b>	16-Rp½"FT-20	960	5	St. E1	<b>80,53</b>
<b>1070633</b>	25-Rp½"FT-25	576	3	St. E1	<b>118,92</b>
<b>1070634</b>	25-Rp½"FT-20	576	3	St. E1	<b>126,24</b>

## Uponor S-Press PLUS Schallset U-Wandscheibe

 <b>1121194</b>	16-20	384	1	St. E1	<b>25,91</b>
--	-------	-----	---	-----------	--------------

# Uponor S-Press PLUS

Art-Nr.	Dimension	LE	VE	ME RG	Preis/ME
---------	-----------	----	----	----------	----------

## Uponor S-Press PLUS U-Armaturenanschluss

 <b>1070636</b>	16-16-R $\frac{1}{2}$ "MT	960	5	St. E1	<b>105,24</b>
<b>1070637</b>	20-20-R $\frac{3}{4}$ "MT	960	5	St. E1	<b>105,24</b>

## Uponor S-Press PLUS Doppel-Wands. 90° L long

 <b>1070648</b>	16-Rp $\frac{1}{2}$ "FT-16	40	10	St. E1	<b>52,67</b>
<b>1070649</b>	20-Rp $\frac{1}{2}$ "FT-20	40	10	St. E1	<b>61,58</b>

## Uponor S-Press PLUS Anschlusswink. flach

 <b>1070657</b>	16-Rp $\frac{1}{2}$ "FT	10	1	St. E1	<b>38,22</b>
--	-------------------------	----	---	-----------	--------------

## Uponor S-Press PLUS SK-T-Stück Geberit

 <b>1070659</b>	16-G $\frac{1}{2}$ "FT-16	10	1	St. E1	<b>45,49</b>
--	---------------------------	----	---	-----------	--------------

## Uponor S-Press PLUS SK-Winkelverschraub. Geberit

 <b>1070658</b>	16- $\frac{1}{2}$ "FT	80	20	St. E1	<b>24,24</b>
--	-----------------------	----	----	-----------	--------------

## Uponor S-Press PLUS Endstück

 <b>1070621</b>	16	160	40	St. E1	<b>11,92</b>
<b>1070622</b>	20	7680	20	St. E1	<b>20,21</b>
<b>1070623</b>	25	3840	10	St. E1	<b>23,25</b>
<b>1070624</b>	32	1920	5	St. E1	<b>29,50</b>

## Uponor S-Press PLUS Abdrückstopfen

 <b>1013754</b>	14	7680	20	St. E1	<b>27,16</b>
<b>1013756</b>	16	7680	20	St. E1	<b>27,16</b>
<b>1013760</b>	20	3840	20	St. E1	<b>29,27</b>
<b>1013762</b>	25	3840	10	St. E1	<b>32,05</b>
<b>1013764</b>	32	3840	10	St. E1	<b>49,19</b>
<b>1013765</b>	40	960	5	St. E1	<b>62,95</b>

## Uponor S-Press PLUS O-Ring für Abdrückstopfen

 <b>1013798</b>	14	10000	10	St. E1	<b>0,66</b>
<b>1013799</b>	16	1000	10	St. E1	<b>0,84</b>
<b>1013801</b>	20	1000	10	St. E1	<b>1,20</b>
<b>1013802</b>	25	500	10	St. E1	<b>1,34</b>
<b>1013803</b>	32	500	10	St. E1	<b>1,34</b>
<b>1013804</b>	40	-	10	St. E1	<b>1,82</b>

Art-Nr.	Dimension	LE	VE	ME RG	Preis/ME
---------	-----------	----	----	----------	----------

## Uponor S-Press PLUS Montageeinheit mit Schallset

 <b>1070666</b>	16-Rp $\frac{1}{2}$ "FT c/c150mm	150	5	St. E1	<b>88,34</b>
--	----------------------------------	-----	---	-----------	--------------

## Uponor S-Press PLUS Montageeinheit

 <b>1070661</b>	16-Rp $\frac{1}{2}$ "FT c/c80mm	5	1	St. E1	<b>66,84</b>
<b>1070662</b>	16-Rp $\frac{1}{2}$ "FT c/c150mm	380	5	St. E1	<b>66,84</b>

## Uponor S-Press PLUS Montageeinheit Gemini

 <b>1070663</b>	16-Rp $\frac{1}{2}$ "FT c/c120mm	720	5	St. E1	<b>67,26</b>
<b>1070664</b>	16-Rp $\frac{1}{2}$ "FT c/c150mm	720	5	St. E1	<b>67,26</b>

## Uponor S-Press PLUS Mauerdurchführung

 <b>1070652</b>	16-G $\frac{1}{2}$ "FT	5	1	St. E1	<b>41,88</b>
--	------------------------	---	---	-----------	--------------

## Uponor S-Press PLUS Wanddurchführung Eck LWC

 <b>1070654</b>	16-Rp $\frac{1}{2}$ "FT l=35	5	1	St. E1	<b>81,22</b>
--	------------------------------	---	---	-----------	--------------

## Uponor S-Press PLUS Montageplatte

 <b>1121197</b>	80/150mm	5	1	St. E1	<b>13,61</b>
---	----------	---	---	-----------	--------------

## Uponor S-Press PLUS Montagewinkel

 <b>1121196</b>	100mm	5	1	St. E1	<b>15,40</b>
<b>1121195</b>	80/150mm	5	1	St. E1	<b>17,02</b>

## Uponor Smart Aqua Montagewinkel Gemini

 <b>1059825</b>	150mm	5	1	St. E1	<b>10,11</b>
--	-------	---	---	-----------	--------------

## Uponor Smart Aqua Einzelmontagewinkel

 <b>1057843</b>		5	1	St. E1	<b>10,79</b>
--	--	---	---	-----------	--------------

## Uponor Smart Aqua Montageschiene

 <b>1057844</b>	2m	10	1	St. E1	<b>54,18</b>
--	----	----	---	-----------	--------------

## Uponor Smart Aqua Biegezange f. Schiene

 <b>1015424</b>	2m	-	1	St. NET	<b>173,55</b>
--	----	---	---	------------	---------------

## Uponor Smart Aqua 10 Bolzen+20 Schrauben

 <b>1057847</b>		-	1	Set E1	<b>18,11</b>
--	--	---	---	-----------	--------------

# Uponor S-Press PLUS Systemübergänge

Art-Nr.	Dimension	LE	VE	ME RG	Preis/ME
 <b>1015168</b>	16-16	80	20	St. U2	<b>22,99</b>
<b>1015192</b>	20-20	3840	10	St. U2	<b>24,05</b>
<b>1015210</b>	25-26	-	5	St. U2	<b>41,42</b>
<b>1015224</b>	32-32	1920	5	St. U2	<b>49,35</b>

## Uponor S-Press Übergangskupplung auf Rapex

 <b>1015167</b>	16-16	80	20	St. U2	<b>22,99</b>
<b>1015190</b>	20-20	3840	10	St. U2	<b>24,05</b>
<b>1015208</b>	25-26	1920	5	St. U2	<b>33,77</b>
<b>1015222</b>	32-32	1920	5	St. U2	<b>39,20</b>

## Uponor S-Press Kupplung auf Edelstahl/CU V

 <b>1090678</b>	16-15CU-SST	10	1	St. E1	<b>28,99</b>
<b>1090679</b>	20-22CU-SST	5	1	St. E1	<b>42,20</b>
<b>1090680</b>	25-22CU-SST	5	1	St. E1	<b>44,96</b>
<b>1090681</b>	32-28CU-SST	5	1	St. E1	<b>63,71</b>

## Uponor S-Press Kupplung auf Edelstahl/CU M

 <b>1090682</b>	16-15CU-SST	10	1	St. E1	<b>28,99</b>
<b>1090683</b>	20-22CU-SST	5	1	St. E1	<b>42,20</b>
<b>1090684</b>	25-22CU-SST	5	1	St. E1	<b>44,96</b>
<b>1090685</b>	32-28CU-SST	5	1	St. E1	<b>63,71</b>

Art-Nr.	Dimension	LE	VE	ME RG	Preis/ME
 <b>1070705</b>	16-10CU	80	20	St. E1	<b>19,16</b>
<b>1070706</b>	16-12CU	80	20	St. E1	<b>19,25</b>
<b>1070615</b>	16-15CU	160	20	St. E1	<b>19,42</b>
<b>1070616</b>	20-18CU	40	10	St. E1	<b>25,59</b>
<b>1070617</b>	20-22CU	60	15	St. E1	<b>26,30</b>
<b>1070618</b>	25-22CU	20	5	St. E1	<b>31,67</b>
<b>1070620</b>	32-28CU	20	5	St. E1	<b>47,94</b>

## Uponor S-Press Kupplung reduziert

 <b>1015172</b>	18-16	80	20	St. E1	<b>24,06</b>
<b>1015185</b>	20-18	80	10	St. E1	<b>24,39</b>

# Uponor S-Press PLUS Ventile

Art-Nr.	Dimension	LE	VE	ME RG	Preis/ME
 <b>1119311</b>	20	5	1	St. E1	<b>121,28</b>
<b>1119312</b>	25	5	1	St. E1	<b>181,98</b>
<b>1119313</b>	32	5	1	St. E1	<b>272,91</b>

## Uponor S-Press Schrägsitzventil

 <b>1119314</b>	40	5	1	St. E1	<b>318,44</b>
--	----	---	---	-----------	---------------

## Uponor S-Press PLUS Schrägsitzventil RV

 <b>1119315</b>	20	5	1	St. E1	<b>151,63</b>
<b>1119316</b>	25	5	1	St. E1	<b>191,09</b>
<b>1119317</b>	32	5	1	St. E1	<b>294,15</b>

## Uponor S-Press Schrägsitzventil RV

 <b>1119318</b>	40	5	1	St. E1	<b>369,91</b>
--	----	---	---	-----------	---------------

## Uponor S-Press PLUS Dämmschale

 <b>1137490</b>	20	10	1	St. E1	<b>22,39</b>
<b>1137491</b>	25	10	1	St. E1	<b>24,36</b>
<b>1137492</b>	32/40	6	1	St. E1	<b>32,02</b>

## Uponor S-Press PLUS Unterputzventil

 <b>1119321</b>	16	5	1	St. E1	<b>103,07</b>
<b>1119322</b>	20	5	1	St. E1	<b>153,08</b>
<b>1119323</b>	25	5	1	St. E1	<b>163,77</b>

Art-Nr.	Dimension	LE	VE	ME RG	Preis/ME
 <b>1119319</b>	16mm	-	1	St. E1	<b>473,11</b>
<b>1119320</b>	20mm	-	1	St. E1	<b>477,59</b>





## Uponor S-Press PLUS Probeentnahmeventil

 <b>1119848</b>	DN 8	10	1	St. E1	<b>133,83</b>
--	------	----	---	-----------	---------------



## Uponor S-Press PLUS Wasserzählerbox

 <b>1119324</b>	G2" Coax DN 3/4"	60	1	St. E1	<b>488,35</b>
--	------------------	----	---	-----------	---------------



# Uponor S-Press PLUS Heizung

Art-Nr.	Dimension	LE	VE	ME RG	Preis/ME
 <b>1070689</b>	16-16-16	192	1	St. E2	<b>103,27</b>
 <b>1070690</b>	20-16-16	192	1	St. E2	<b>110,27</b>
 <b>1070691</b>	20-16-20	192	1	St. E2	<b>110,27</b>
 <b>1070692</b>	20-20-20	192	1	St. E2	<b>103,27</b>





## Uponor Smart Radi Anschlussblock

 <b>1013134</b>	16 h=215mm	240	10	St. E2	<b>54,09</b>
 <b>1007077</b>	16 h=240mm	240	10	St. E2	<b>67,70</b>

## Uponor S-Press PLUS HK-Anschlusswinkel plated

 <b>1070678</b>	16-15CU l=350mm	1680	20	St. E2	<b>27,45</b>
 <b>1070679</b>	16-15CU l=1000mm	400	20	St. E2	<b>50,23</b>

## Uponor S-Press PLUS SL-Anschlussgarnitur

 <b>1070693</b>	16-G½"MT-16	192	1	St. E2	<b>116,97</b>
 <b>1070695</b>	16-G½"MT-0	192	1	St. E2	<b>116,97</b>
 <b>1094219</b>	0-G½"MT-16	192	1	St. E2	<b>116,97</b>
 <b>1070697</b>	20-G½"MT-20	192	1	St. E2	<b>116,97</b>

## Uponor S-Press PLUS SL-Winkel SL

 <b>1014060</b>	15x1	25	1	Set E2	<b>112,19</b>
--	------	----	---	-----------	---------------

## Uponor S-Press PLUS HK-Montageplatte radi

 <b>1070684</b>	16-Rp½"FT c/c50mm	960	5	St. E2	<b>66,76</b>
--	-------------------	-----	---	-----------	--------------

## Uponor Smart Radi Anschlussrohr

 <b>1015425</b>	G½"MT-15CU l=350mm	640	20	St. E2	<b>37,37</b>
--	--------------------	-----	----	-----------	--------------

Art-Nr.	Dimension	LE	VE	ME RG	Preis/ME
 <b>1013830</b>	15CU-¾" Euro	80	10	St. D1	<b>9,27</b>

## Uponor Smart Radi Klemmverschraubung Cu

## Uponor Smart Radi Anschlussnippel

 <b>1013906</b>	G¾"MT-G½"MT	80	10	St. D1	<b>8,43</b>
--	-------------	----	----	-----------	-------------

## Uponor Smart Radi Anschlussgarnitur Danfoss

 <b>1013970</b>	16-G½"MT	20	1	St. E2	<b>10,68</b>
--	----------	----	---	-----------	--------------

## Uponor Smart Radi Anschlussgarnitur Heimeier

 <b>1013978</b>	16-G½"MT	20	1	St. E2	<b>10,07</b>
--	----------	----	---	-----------	--------------

## Uponor Smart Radi Anschlussgarnitur Oventrop

 <b>1014016</b>	16-G½"MT	20	1	St. E2	<b>14,09</b>
--	----------	----	---	-----------	--------------

## Uponor Smart Radi Anschlusset

 <b>1011364</b>		100	10	St. E2	<b>18,29</b>
--	--	-----	----	-----------	--------------

## Uponor Smart Radi Rosette weiß

 <b>1011370</b>	16 white	1350	50	St. E2	<b>1,02</b>
--	----------	------	----	-----------	-------------

## Uponor Smart Radi Stufen-Doppelrosette

 <b>1011373</b>	14-20 white double	500	50	St. D1	<b>3,65</b>
--	--------------------	-----	----	-----------	-------------





# Uponor RS

Art-Nr.	Dimension	LE	VE	ME RG	Preis/ME
---------	-----------	----	----	----------	----------

## Uponor RS Kupplung

 <b>1029144</b>	RS2-RS2	480	1	St. E1	<b>49,11</b>
<b>1029145</b>	RS3-RS3	480	1	St. E1	<b>106,35</b>

## Uponor RS Winkel

 <b>1029138</b>	RS2-RS2	336	1	St. E1	<b>67,12</b>
<b>1029139</b>	RS3-RS3	240	1	St. E1	<b>172,73</b>

## Uponor RS Winkel 45°

 <b>1029140</b>	RS2-RS2	336	1	St. E1	<b>80,09</b>
<b>1029141</b>	RS3-RS3	175	1	St. E1	<b>210,00</b>

## Uponor RS T-Stück

 <b>1029142</b>	RS2-RS2-RS2	336	1	St. E1	<b>85,03</b>
<b>1029143</b>	RS3-RS3-RS3	175	1	St. E1	<b>225,21</b>

## Uponor RS Kupplung reduziert

 <b>1029146</b>	RS3-RS2	480	1	St. E1	<b>99,48</b>
--	---------	-----	---	-----------	--------------

## Uponor RS Distanzadapter

 <b>1046750</b>	RS2-RS2 l=5mm	480	1	St. E1	<b>75,97</b>
<b>1046751</b>	RS3-RS3 l=5mm	240	1	St. E1	<b>92,89</b>

## Uponor RS Distanzadapter

 <b>1046477</b>	RS2-RS2 l=130mm	240	1	St. E1	<b>133,96</b>
<b>1046478</b>	RS3-RS3 l=210mm	96	1	St. E1	<b>254,11</b>

## Uponor RS Adapter S-Press

 <b>1059397</b>	16-RS2	480	1	St. E1	<b>55,25</b>
--	--------	-----	---	-----------	--------------

## Uponor RS Adapter S-Press PLUS

 <b>1095818</b>	20-RS2	378	1	St. E1	<b>46,85</b>
<b>1095819</b>	25-RS2	378	1	St. E1	<b>46,85</b>
<b>1095820</b>	32-RS2	378	1	St. E1	<b>46,85</b>

## Uponor RS Adapter S-Press

 <b>1046940</b>	40-RS2	480	1	St. E1	<b>46,11</b>
<b>1046941</b>	50-RS2	480	1	St. E1	<b>48,43</b>
<b>1029125</b>	63-RS2	400	1	St. E1	<b>58,31</b>
<b>1029126</b>	75-RS2	400	1	St. E1	<b>93,48</b>
<b>1029127</b>	90-RS3	240	1	St. E1	<b>187,81</b>
<b>1029128</b>	110-RS3	240	1	St. E1	<b>209,66</b>

Art-Nr.	Dimension	LE	VE	ME RG	Preis/ME
---------	-----------	----	----	----------	----------

## Uponor RS Gewindeadapter Nippel

 <b>1029131</b>	R2*MT-RS2	480	1	St. E1	<b>59,40</b>
<b>1029132</b>	R2 ½"MT-RS2	480	1	St. E1	<b>88,45</b>
<b>1029133</b>	R3*MT-RS3	240	1	St. E1	<b>102,28</b>

## Uponor RS Gewindeadapter Muffe

 <b>1059403</b>	Rp½"FT-RS2	480	1	St. E1	<b>89,80</b>
<b>1029134</b>	Rp1"FT-RS2	480	1	St. E1	<b>58,21</b>
<b>1029135</b>	Rp2"FT-RS2	480	1	St. E1	<b>69,79</b>
<b>1029136</b>	Rp2 ½"FT-RS2	480	1	St. E1	<b>102,17</b>
<b>1059404</b>	Rp½"FT-RS3	336	1	St. E1	<b>103,13</b>
<b>1029137</b>	Rp3"FT-RS3	240	1	St. E1	<b>94,04</b>

## Uponor RS Flansch Adapter

 <b>1059398</b>	RS2-DN65 (PN6)	144	1	St. E1	<b>306,06</b>
<b>1059399</b>	RS2-DN65 (PN16)	90	1	St. E1	<b>362,08</b>
<b>1029129</b>	RS3-DN80 (PN16)	90	1	St. E1	<b>393,48</b>
<b>1029130</b>	RS3-DN100 (PN16)	90	1	St. E1	<b>428,06</b>

## Uponor RS Verriegelungselement

 <b>1042921</b>	RS2 black	5000	10	St. U2	<b>28,18</b>
<b>1042922</b>	RS3 black	-	10	St. U2	<b>64,69</b>

Preis pro VE

# Flächenheizung/-kühlung

	Installationsart	System-Platten-dicke	Mindest-Aufbau-höhe* mm	Systemname	Beschreibung	Zugehörige Systemrohre	Dimension (mm)
NASSBAU	Noppenplatte selbstklebend	—	15	<b>Uponor Minitec</b>	Sehr geringe Aufbauhöhe, direkt auf altem Untergrund (Estrich, Fliesen, Holz..)	<b>Comfort Pipe</b>	9,9
	Klettsystem	DES 25-2 30-2 30-3 35-3 WLS032 25-2	74	<b>Uponor Klett</b>	Mikroverzahnung von Systemplatte und Rohr. Schnelle Verlegeart, keine Beschädigung der Estrichfolie	<b>Klett Comfort Pipe PLUS Klett MLCP RED</b>	14, 16 16
	Klett auf bauseitiger Dämmung	—	74	<b>Uponor Klett Twinboard</b>	Klettverlegung auf bauseitiger Dämmung mittels Hohlkammer-Verlegeplatten 3 mm	<b>Klett Comfort Pipe PLUS Klett MLCP RED</b>	14, 16 16
	Klett inkl. Mineralwolle-Dämmung	30	74	<b>Uponor Klett Silent</b>	Klettverlegung auf Mineralwolleplatten, alternative Ausschreibungen	<b>Klett Comfort Pipe PLUS Klett MLCP RED</b>	14, 16 16
	Klett Vermeidung überheizte Flure	32	74	<b>Vario Heat Protect</b>	Rohrträger zur Führung von FBH-Anschlussleitungen unter der Heizestrichschicht	<b>alle Rohrleitungen zum Verteiler</b>	
	Noppenfolie	—	30	<b>Uponor Nubos</b>	Freie Wahl der Dämmschicht	<b>Comfort Pipe PLUS Blue Comfort Pipe Comfort Pipe PLUS MLCP RED</b>	16 16 14 14, 16
	Noppenplatte	11 oder 30-2	82	<b>Uponor Tecto</b>	Schnelle Rohrmontage, Systemplatten für Geschosstrenndecken, sicherer Halt	<b>Comfort Pipe PLUS Blue Comfort Pipe PLUS MLCP RED</b>	16 14, 17 14, 16
	Noppenplatte	11 oder 30-2	78	<b>Uponor Nubos</b>	Einfach in der Anwendung, normgerechte Verlegeabstände	<b>Comfort Pipe PLUS Blue Comfort Pipe Comfort Pipe PLUS MLCP RED</b>	16 16 14 14, 16
	Stahlmatten mit Clip	—	83	<b>Uponor Classic</b>	Höchster Schallschutz (bauseitige Mineralwolldämmung). Trennung der Gewerke Estrich/Heizung, große Heizkreise	<b>Comfort Pipe PLUS Blue Comfort Pipe PLUS Magna Pipe PLUS</b>	16, 20 17 20
	Tacker	EPS DEO 20, 30 DES 20-2, 30-2, 30-3, 35-3, 40-3	75	<b>Uponor Tacker</b>	Preiswerteste Lösung. Unterschiedliche Wärme-/Trittschalldämmschichten lieferbar	<b>Comfort Pipe PLUS Blue Comfort Pipe MLCP RED</b>	16 16 14, 16
TROCKEN	Vorgeformte EPS-Platten und Alu-Wärmeleitlamellen	25	50	<b>Uponor Siccus 14</b>	Geringes Gewicht, sofort nutzbar, hohe Tragfähigkeit	<b>Comfort Pipe PLUS MLCP RED</b>	14 14
	Vorgeformte EPS-Platten mit vollflächiger Wärmeübertragungsschicht aus Aluminium	15	15	<b>Uponor Siccus Mini</b>	Geringes Gewicht, sofort nutzbar, sehr geringe Aufbauhöhe	<b>Comfort Pipe</b>	9,9

\* Systemplatte + Lastverteilschicht

# Uponor Systeme zum Heizen und Kühlen

	Installationsart	System-Platten-dicke	Mindest-Aufbau-höhe* mm	Systemname	Beschreibung	Zugehörige Systemrohre	Dimension (mm)	
<b>WAND</b>	<b>NASS</b>	Unter Putz, mit Klemmschiene	—	32	<b>Uponor Fix</b>	Effiziente und drallfreie Rohrverlegung von der Großrolle mit minimalem Verschnitt	<b>Comfort Pipe</b> <b>Comfort Pipe PLUS</b> <b>MLCP RED</b>	9,9 14 14
	<b>TROCKEN</b>	In vorgeformten EPS-Platten	25	30	<b>Uponor Siccus Wall</b>	Keine Trocknungszeiten und kein Funktionsheizen erforderlich	<b>Comfort Pipe PLUS</b> <b>MLCP RED</b>	14 14
		Auf CD-Profile 60/27, Gipspanel mit integrierten Heizrohren	—	15	<b>Uponor Renovis</b>	Faserverstärkte Gipsplatte 15 mm, Montage auf definierte Trockenbau-Unterkonstruktionen	<b>Comfort Pipe (integriert)</b>	9,9
<b>DECKE</b>	<b>NASS</b>	Unter Putz, mit Klemmschiene	—	32	<b>Uponor Fix</b>	Effiziente und drallfreie Rohrverlegung von der Großrolle mit minimalem Verschnitt	<b>Comfort Pipe</b>	9,9
	<b>TROCKEN</b>	Auf CD-Profile 60/27, Gipspanel mit integrierten Heizrohren	—	15	<b>Uponor Renovis</b>	Hohe Verlegeleistungen auf CD-Profilen	<b>Comfort Pipe (integriert)</b>	9,9
		Gipspanel inkl. EPS-Dämmung	27	27	<b>Uponor Teporis</b>	27 mm EPS Wärmedämmplatte	<b>Comfort Pipe (integriert)</b>	9,9
		Standard Unterkonstruktionen	—	15	<b>Uponor Thertatop M</b>	Fugen- und richtungslose Deckenoberflächen	<b>Uni Pipe PLUS</b>	16
<b>WEITERE ANWENDUNGEN</b>	<b>HALLEN</b>	<b>INDUSTRIEFLÄCHENHEIZUNG</b>						
		Auf Klemmschiene			<b>Uponor Magna</b>	Optimale Raumnutzung ohne störende Anlagenkomponenten	<b>Magna Pipe PLUS</b> <b>Comfort Pipe PLUS Blue</b>	20, 25 20
		Auf Stahlmatten						
	<b>TABS</b>	<b>BETONKERNAKTIVIERUNG</b>						
		Vorgefertigte Module auf Stahlmatte (Bewehrung)			<b>Uponor Contec</b>	Für die Einbringung in den Betonkern	<b>Magna Pipe PLUS</b>	20
		Oberflächennah			<b>Uponor Contec ON</b>	Diagonal verspannte Wabengitter mit vorbereiteten Rohren zum oberflächennahen Einbau in die Betonschalung	<b>Comfort Pipe PLUS</b> <b>Magna Pipe PLUS</b>	14 20
	<b>TROCKEN</b>	<b>SPORTBODEN</b>						
In Sporthallen		30		<b>Uponor Siccus Sport</b>	Für flächenelastische Sportböden in Sandwichbauweise	<b>Comfort Pipe PLUS</b> <b>MLC weiß</b>	14 14	
In Sporthallen				<b>Uponor Sport</b>	Zum Einbau zwischen Unterzügen flächenelastischer Sportböden	<b>Magna Pipe PLUS</b>	25	

\* Systemplatte + Lastverteilschicht

# Flächenheizung/-kühlung

## Uponor Heizrohre und Verbindungstechniken

Typ	Ab- messung [mm]	Diffusionssperre	Rohrfarbe, Kennzeichnung	Druck [bar]	Tempe- ratur [°C]	Länge [m]	Artikel-Nr.	DIN- Certco Zerti- fikat-Nr.
<b>Comfort Pipe PLUS</b> 	14 x 2,0	PE-Xa + EVOH Sperrschicht	weiß, 2 blaue Streifen	6	70	120 240 640 960	1062883 1062884 1088166 1062885	3V372
	17 x 2,0	PE-Xa + EVOH Sperrschicht	weiß, 2 blaue Streifen	6	70	120 240 480 640	1034535 1009226 1086340 1009227	3V372
	20 x 2,0	PE-Xa + EVOH Sperrschicht	weiß, 2 blaue Streifen	6	70	60	1009229	3V372
<b>Comfort Pipe PLUS Blue</b> 	16 x 2,0	PE-Xa + EVOH Sperrschicht	weiß, 2 blaue Streifen	6	70	640	1126541	3V372 ISCC-zertifiziert
	20 x 2,0	PE-Xa + EVOH Sperrschicht	weiß, 2 blaue Streifen	6	70	480	1126542	3V372 ISCC-zertifiziert
<b>Klett Comfort Pipe PLUS</b> 	14 x 2,0	PE-Xa + EVOH Sperrschicht	weiß, 2 blaue Streifen, mit Klettband	6	70	240 640	1088479 1088480	3V372
	16 x 2,0	PE-Xa + EVOH Sperrschicht	weiß, 2 blaue Streifen, mit Klettband	6	70	240 640	1087302 1087303	3V372
<b>Magna Pipe PLUS</b> 	20 x 2,0	PE-Xa + EVOH Sperrschicht	weiß, 2 blaue Streifen	6	70	240 480	1091275 1091276	3V415
	25 x 2,3	PE-Xa + EVOH Sperrschicht	weiß, 2 blaue Streifen	6	70	300 640	1091277 1091278	3V415
<b>Comfort Pipe</b> 	16 x 1,8	PE-Xa + EVOH Sperrschicht	weiß, 1 blauer Streifen	6	70	240 640	1047622 1047623	3V417
<b>Minitec Comfort Pipe</b> 	9,9 x 1,1	PE-Xa + EVOH Sperrschicht	natur, 1 blauer Streifen	6	70	60 120 480	1063287 1063288 1063381	3V279
<b>MLC Rohr weiß</b> 	14 x 2,0	Verbundrohr mit AL	weiß	10	80	200	1013366	
<b>MLCP RED</b> 	14 x 1,6	Verbundrohr mit AL	rot, innen blau	4	60	240 480	1096010 1096011	3V286
	16 x 2,0	Verbundrohr mit AL	rot, innen blau	4	60	240 480	1096012 1096013	3V445
<b>MLCP RED Klett</b> 	16 x 2,0	Verbundrohr mit AL	weiß, innen blau, 2 rote Streifen, mit Klettband	4	60	240 480	1096014 1096015	3V286

## Verbindungstechnik, Fittings und Werkzeug für Flächenheizsysteme

(Klemmring-) Verschraubungen



Maulschlüssel handelsüblich



Quick und Easy Fittings



Q+E-Aufweitwerkzeuge



zugehörige Q+E-Sicherungsringe



rapex Pressfittings



rapex Pressbacken



Smart Presskupplungen



Pressbacken MLC UPP1 und KSP0















S-Press und S-Press-PLUS Kupplungen













Vario/Fit 14x2,0	-	-	14	14	-
Vario/Fit 17x2,0	M12 & M18	natur eval & weiß	17	-	-
Vario/Fit 20x1,9/2,0	M12 & M18	natur eval & weiß	-	20	-
Vario/Fit 16x1,8/2,0	M12 & M18	natur eval & weiß	16	16	-
Vario/Fit 20x1,9/2,0	M12 & M18	natur eval & weiß	-	20	-
Vario/Fit 14x2,0	-	-	14	14	-
Vario/Fit 16x1,8/2,0	M12 & M18	natur eval & weiß	16	16	-
Vario/Fit 20x1,9/2,0	M12 & M18	natur eval & weiß	-	20	-
Vario/Fit 25x2,3	M12 & M18	natur eval & weiß	25	-	-
Vario/Fit 16x1,8/2,0	M12 & M18	natur eval & weiß	16	16	-
Vario & Minitec 9,9 x 1,1	Hand, M12 & M18	Minitec PEX	-	-	-
Uni-X 14-3/4 Euro	-	-	-	-	14
Vario MLCP RED 14x1,6 Euro	-	-	-	-	14 MLCP RED Press-Kupplung
Uni-X 16-3/4 Euro	-	-	-	-	16
Uni-X 16-3/4 Euro	-	-	-	-	16

Flächenheizung und -kühlung

# Uponor Minitec

Art-Nr.	Dimension	LE	VE	ME RG	Preis/ME
<b>Uponor Minitec Folienelement</b>					
 <b>1005261</b>	15,4m <sup>2</sup> 9,9x1,1 1100x700x12mm	123,2	15,4	m <sup>2</sup> M <sup>2</sup>	<b>42,28</b>
<b>Uponor Fix Klemmschiene</b>					
 <b>1005274</b>	9,9mm c/c20mm 2,5m	25	2,5	m M <sup>2</sup>	<b>7,36</b>
<b>Uponor Minitec Randdämmstreifen klebend</b>					
 <b>1005267</b>	20m 80x8mm	-	200	m M <sup>2</sup>	<b>1,94</b>
<b>Uponor Minitec Bewegungsfugenprofil</b>					
 <b>1085980</b>	0,9m 40x10mm	600	10	St. M <sup>2</sup>	<b>12,82</b>
<b>1085981</b>	1,3m 40x10mm	600	10	St. M <sup>2</sup>	<b>16,25</b>
<b>Uponor Comfort Pipe Rohr Minitec</b>					
 <b>1063287</b>	9,9x1,1 60m	840	60	m M <sup>2</sup>	<b>4,20</b>
<b>1063288</b>	9,9x1,1 120m	1680	120	m M <sup>2</sup>	<b>4,20</b>
<b>1063289</b>	9,9x1,1 240m	2640	240	m M <sup>2</sup>	<b>4,20</b>
<b>1063381</b>	9,9x1,1 480m	2880	480	m M <sup>2</sup>	<b>4,20</b>
<b>Uponor Minitec Schutzhülse</b>					
 <b>1005269</b>	9,9mm 300x2mm	3600	30	St. M <sup>2</sup>	<b>2,32</b>
<b>Uponor Minitec Eurokonusverschraubung</b>					
 <b>1005266</b>	9,9x1,1-G $\frac{3}{4}$ "Euro	100	10	St. M <sup>2</sup>	<b>13,21</b>
<b>Uponor Minitec Kupplung</b>					
 <b>1005264</b>	9,9x1,1	100	10	St. M <sup>2</sup>	<b>11,45</b>
<b>Uponor Minitec Übergangsnippel</b>					
 <b>1005265</b>	9,9-R $\frac{1}{2}$ "MT	100	10	St. M <sup>2</sup>	<b>14,05</b>
<b>Uponor Minitec Ring</b>					
 <b>1005263</b>	9,9x1,1	1600	10	St. M <sup>2</sup>	<b>0,76</b>
<b>Uponor Minitec Klemmringverschraubung</b>					
 <b>1013426</b>	9,9- $\frac{3}{4}$ "Euro	120	12	St. M <sup>2</sup>	<b>22,14</b>
<b>Uponor Minitec Schraubkupplung</b>					
 <b>1016690</b>	9,9-9,9	48	12	St. M <sup>2</sup>	<b>52,66</b>
<b>Uponor Fluvia Hosenstück</b>					
 <b>1005675</b>	2xG $\frac{3}{4}$ - $\frac{3}{4}$ "Euro	50	1	Set MZ	<b>62,46</b>

Art-Nr.	Dimension	LE	VE	ME RG	Preis/ME
<b>Uponor Fluvia T Pumpengruppe Push-12 TH-G</b>					
 <b>1095127</b>		60	1	St. MZ	<b>812,99</b>
<b>Uponor Fluvia T Pumpengruppe Push-12 CH-G</b>					
 <b>1095131</b>		30	1	St. MZ	<b>1913,91</b>
<b>Uponor Fluvia T Pumpengruppe Push-12 AC-G</b>					
 <b>1095128</b>		60	1	St. MZ	<b>964,13</b>
<b>Uponor Fluvia T Pumpengruppe Push-12 WL-G</b>					
 <b>1095130</b>		60	1	St. MZ	<b>1287,79</b>
<b>Uponor Vario Füll / Entleerungshahn</b>					
 <b>1061802</b>	$\frac{3}{4}$ " - $\frac{3}{4}$ "	10	1	Set MZ	<b>77,55</b>
<b>Uponor Multi Rohrführungsbogen</b>					
 <b>1135490</b>	10-12	360	60	St. D1	<b>1,51</b>
<b>Uponor Minitec Anschlussbox-UP</b>					
 <b>1005270</b>	1x	30	1	St. M <sup>2</sup>	<b>412,16</b>
<b>1005271</b>	2x	-	1	St. M <sup>2</sup>	<b>577,04</b>
<b>1005272</b>	3x	-	1	St. M <sup>2</sup>	<b>609,10</b>
Die Begrenzung der Auslegungstemperatur muss durch eine Vorregelung sichergestellt sein.					
<b>Uponor Minitec Abdeckplatte</b>					
 <b>1007251</b>		-	1	St. M <sup>2</sup>	<b>167,94</b>
<b>Uponor Base Raumfühler T-23 standard</b>					
 <b>1058422</b>	230V RAL9010	160	1	St. MZ	<b>58,57</b>
<b>Uponor Minitec Aufweitwerkzeug</b>					
 <b>1006247</b>	9,9x1,1	11	1	Set NET	<b>399,92</b>
<b>Uponor Q&amp;E Aufweitwerkzeug mit Aufweitk. M12/</b>					
 <b>1119375</b>	6bar 9,9RS/20	-	1	Set NET	<b>702,82</b>

# Uponor Tecto

Art-Nr.	Dimension	LE	VE	ME RG	Preis/ME
---------	-----------	----	----	----------	----------

## Uponor Tecto Noppenplatte

 <b>1005478</b>	EPS DES 30-2mm 14-17mm 1450x850mm	53,76	8,96	m <sup>2</sup> M4	<b>30,07</b>
<b>1005477</b>	EPS 11mm 14-17mm 1450x850mm	94,08	15,68	m <sup>2</sup> M4	<b>27,62</b>

## Uponor Tecto Diagonal-Rohrfixierung

 <b>1005482</b>	45deg 75mm	420	10	St. M4	<b>2,52</b>
--	------------	-----	----	-----------	-------------

## Uponor Tecto Zwillingstreifen

 <b>1005484</b>	1,4m 100mm	742,5	33,75	m M4	<b>4,55</b>
--	------------	-------	-------	---------	-------------

## Uponor Tecto Abdeckfolie

 <b>1005481</b>	1,45m 200mm	504	28	m M4	<b>4,81</b>
--	-------------	-----	----	---------	-------------

## Uponor Tecto Dämmstreifen

 <b>1005480</b>	EPS DES 30-2mm 150x1400mm	268,8	8,4	m M4	<b>7,06</b>
<b>1005479</b>	EPS 11mm 150x1400mm	716,8	22,4	m M4	<b>6,22</b>

## Uponor Multi Randdämmstreifen mit Folie

 <b>1000079</b>	150x8mm	-	200	m MZ	<b>1,54</b>
---	---------	---	-----	---------	-------------

Hinweis: Verkauf pro Verpackungseinheit.

## Uponor Multi Randdämmstreifen Klebefolie

 <b>1000080</b>	150x10mm	-	200	m MZ	<b>3,15</b>
--	----------	---	-----	---------	-------------

Hinweis: Verkauf pro Verpackungseinheit.

## Uponor Multi PE Randdämmstreifen mit Klebefolie HB

 <b>1135494</b>	150x8mm	-	250	m MZ	<b>1,54</b>
--	---------	---	-----	---------	-------------

Hinweis: Verkauf pro Verpackungseinheit.

## Uponor Multi Dehnungsfugenprofil

 <b>1090229</b>	1800x100x10mm	720	18	m MZ	<b>14,47</b>
--	---------------	-----	----	---------	--------------

## Uponor Multi Schutzhülse

 <b>1000082</b>	20mm 300x5mm	1800	30	St. MZ	<b>1,40</b>
--	--------------	------	----	-----------	-------------

## Uponor Comfort Pipe PLUS Blue Rohr

 <b>1126541</b>	16x2,0 640m	640	640	m M0	<b>4,34</b>
--	-------------	-----	-----	---------	-------------

## Uponor Comfort Pipe PLUS Rohr

 <b>1062883</b>	14x2,0 120m	1320	120	m M0	<b>3,47</b>
<b>1062884</b>	14x2,0 240m	1680	240	m M0	<b>3,47</b>
<b>1088166</b>	14x2,0 640m	1920	640	m M0	<b>3,47</b>
<b>1062885</b>	14x2,0 960m	1920	960	m M0	<b>3,47</b>
<b>1034535</b>	17x2,0 120m	840	120	m M0	<b>3,64</b>
<b>1009226</b>	17x2,0 240m	1200	240	m M0	<b>3,64</b>
<b>1086340</b>	17x2,0 480m	960	480	m M0	<b>3,64</b>
<b>1009227</b>	17x2,0 640m	1280	640	m M0	<b>3,64</b>

Art-Nr.	Dimension	LE	VE	ME RG	Preis/ME
---------	-----------	----	----	----------	----------

## Uponor Vario Klemmringverschraubung PEX

 <b>1065283</b>	14x2,0-G $\frac{3}{4}$ "FT Euro	25	1	St. MZ	<b>8,06</b>
<b>1065284</b>	16x1,8/2,0-G $\frac{3}{4}$ "FT Euro	25	1	St. MZ	<b>8,06</b>
<b>1065286</b>	17x2,0-G $\frac{3}{4}$ "FT Euro	25	1	St. MZ	<b>8,06</b>

## Uponor Fit Schraubkupplung PEX

 <b>1065296</b>	16x1,8/2,0-16x1,8/2,0	25	1	St. MZ	<b>26,18</b>
<b>1065299</b>	17x2,0-17x2,0	25	1	St. MZ	<b>24,88</b>

## Uponor Rapex Press-Kupplung

 <b>1005079</b>	17-17	100	10	St. MZ	<b>15,97</b>
--	-------	-----	----	-----------	--------------

## Uponor Smart Presskupplung

 <b>1089646</b>	14x2,0-14x2,0	80	20	St. MZ	<b>12,02</b>
<b>1089647</b>	16x1,8/2,0-16x1,8/2,0	80	20	St. MZ	<b>13,61</b>

## Uponor MLCP RED Rohr

 <b>1096010</b>	14x1,6 240m	3120	240	m M1	<b>2,07</b>
<b>1096011</b>	14x1,6 480m	3360	480	m M1	<b>2,07</b>
<b>1096012</b>	16x2,0 240m	3120	240	m M1	<b>2,58</b>
<b>1096013</b>	16x2,0 480m	3360	480	m M1	<b>2,58</b>

## Uponor Vario Eurokonusverschraubung MLCP Red

 <b>1000117</b>	14x1,6- $\frac{3}{4}$ "Euro	80	20	St. MZ	<b>6,96</b>
--	-----------------------------	----	----	-----------	-------------

## Uponor MLCP Red Press-Kupplung

 <b>1048272</b>	14x1,6-14x1,6	80	20	St. MZ	<b>12,87</b>
--	---------------	----	----	-----------	--------------

## Uponor S-Press PLUS Kupplung

 <b>1070547</b>	16-16	80	20	St. D1	<b>12,03</b>
--	-------	----	----	-----------	--------------

## Uponor S-Press PLUS Kupplung PPSU

 <b>1039933</b>	16-16	80	20	St. E1	<b>7,56</b>
--	-------	----	----	-----------	-------------

## Uponor Uni-X Verschraubung MLC

 <b>1058090</b>	16- $\frac{3}{4}$ "FT Euro	25	1	St. D1	<b>9,41</b>
--	----------------------------	----	---	-----------	-------------

## Uponor Multi Rohrführungsbogen

 <b>1135491</b>	14-18	240	30	St. D1	<b>3,88</b>
--	-------	-----	----	-----------	-------------

# Uponor Nubos

Art-Nr.	Dimension	LE	VE	ME RG	Preis/ME
 <b>1016699</b>	EPS DES 30-2 14-16mm 1447x900x48mm	10	1	m <sup>2</sup> M4	<b>28,85</b>
<b>1016700</b>	EPS 11 14-16mm 1447x900x29mm	100	10	m <sup>2</sup> M4	<b>26,96</b>

## Uponor Nubos Noppenfolie

 <b>1016703</b>	14-16mm	140	10	m <sup>2</sup> M9	<b>15,93</b>
--	---------	-----	----	----------------------	--------------

## Uponor Nubos Noppenfolie unpacked

 <b>1061880</b>	14-16mm	-	200	m <sup>2</sup> M9	<b>15,18</b>
--	---------	---	-----	----------------------	--------------

## Uponor Nubos Noppen-Verteiler-/Tür Set

 <b>1016701</b>	EPS 30-2 14-16mm 1447x900x48mm	50	5	m <sup>2</sup> M4	<b>33,74</b>
<b>1016702</b>	EPS 11 14-16mm 1447x900x29mm	50	5	m <sup>2</sup> M4	<b>30,30</b>

## Uponor Multi Randdämmstreifen mit Folie

 <b>1000079</b>	150x8mm	-	200	m MZ	<b>1,54</b>
--	---------	---	-----	---------	-------------

Hinweis: Verkauf pro Verpackungseinheit.

## Uponor Multi Randdämmstreifen Klebefolie

 <b>1000080</b>	150x10mm	-	200	m MZ	<b>3,15</b>
--	----------	---	-----	---------	-------------

Hinweis: Verkauf pro Verpackungseinheit.

## Uponor Multi PE Randdämmstreifen mit Klebefolie HB

 <b>1135494</b>	150x8mm	-	250	m MZ	<b>1,54</b>
--	---------	---	-----	---------	-------------

Hinweis: Verkauf pro Verpackungseinheit.

## Uponor Multi Dehnungsfugenprofil

 <b>1090229</b>	1800x100x10mm	720	18	m MZ	<b>14,47</b>
--	---------------	-----	----	---------	--------------

## Uponor Multi Schutzhülse

 <b>1000082</b>	20mm 300x5mm	1800	30	St. MZ	<b>1,40</b>
--	--------------	------	----	-----------	-------------

## Uponor Fix Klemmschiene mit Klebestreifen

 <b>1135496</b>	16-20mm c/c 50mm 1m	2000	100	St. M3	<b>7,23</b>
--	---------------------	------	-----	-----------	-------------

## Uponor Comfort Pipe PLUS Blue Rohr

 <b>1126541</b>	16x2,0 640m	640	640	m M0	<b>4,34</b>
--	-------------	-----	-----	---------	-------------

## Uponor Comfort Pipe PLUS Rohr

 <b>1088166</b>	14x2,0 640m	1920	640	m M0	<b>3,47</b>
--	-------------	------	-----	---------	-------------

## Uponor Comfort Pipe Rohr

 <b>1047622</b>	16x1,8 240m	1440	240	m M1	<b>1,74</b>
<b>1047623</b>	16x1,8 640m	1280	640	m M1	<b>1,74</b>

Art-Nr.	Dimension	LE	VE	ME RG	Preis/ME
 <b>1065283</b>	14x2,0-G <sup>3</sup> / <sub>4</sub> "FT Euro	25	1	St. MZ	<b>8,06</b>
<b>1065284</b>	16x1,8/2,0-G <sup>3</sup> / <sub>4</sub> "FT Euro	25	1	St. MZ	<b>8,06</b>

## Uponor Smart Presskupplung

 <b>1089646</b>	14x2,0-14x2,0	80	20	St. MZ	<b>12,02</b>
<b>1089647</b>	16x1,8/2,0-16x1,8/2,0	80	20	St. MZ	<b>13,61</b>

## Uponor MLCP RED Rohr

 <b>1096010</b>	14x1,6 240m	3120	240	m M1	<b>2,07</b>
<b>1096011</b>	14x1,6 480m	3360	480	m M1	<b>2,07</b>
<b>1096012</b>	16x2,0 240m	3120	240	m M1	<b>2,58</b>
<b>1096013</b>	16x2,0 480m	3360	480	m M1	<b>2,58</b>

## Uponor Vario Eurokonusverschraubung MLCP Red

 <b>1000117</b>	14x1,6- <sup>3</sup> / <sub>4</sub> "Euro	80	20	St. MZ	<b>6,96</b>
--	---	----	----	-----------	-------------

## Uponor MLCP Red Press-Kupplung

 <b>1048272</b>	14x1,6-14x1,6	80	20	St. MZ	<b>12,87</b>
--	---------------	----	----	-----------	--------------

## Uponor Uni-X Verschraubung MLC

 <b>1058090</b>	16- <sup>3</sup> / <sub>4</sub> "FT Euro	25	1	St. D1	<b>9,41</b>
--	--	----	---	-----------	-------------

## Uponor S-Press PLUS Kupplung

 <b>1070547</b>	16-16	80	20	St. D1	<b>12,03</b>
--	-------	----	----	-----------	--------------

## Uponor S-Press PLUS Kupplung PPSU

 <b>1039933</b>	16-16	80	20	St. E1	<b>7,56</b>
--	-------	----	----	-----------	-------------

## Uponor Multi Rohrführungsbogen

 <b>1135491</b>	14-18	240	30	St. D1	<b>3,88</b>
--	-------	-----	----	-----------	-------------



# Uponor Klett

Art-Nr.	Dimension	LE	VE	ME RG	Preis/ME
 <b>1063402</b>	EPS DES 25-2mm 10x1m	80	10	m <sup>2</sup> M6	<b>16,36</b>
<b>1063322</b>	EPS DES 30-2mm 10x1m	80	10	m <sup>2</sup> M6	<b>19,00</b>
<b>1063323</b>	EPS DES 30-3mm 10x1m	80	10	m <sup>2</sup> M6	<b>16,74</b>
<b>1063324</b>	EPS DES 35-3mm 10x1m	70	10	m <sup>2</sup> M6	<b>17,68</b>

## Uponor Klett Rollplatte

 <b>1085788</b>	G EPS DES WLS032 25-2mm 10x1m	80	10	m <sup>2</sup> M6	<b>22,00</b>
--	----------------------------------	----	----	----------------------	--------------

## Uponor Klett Twinboard

 <b>1086854</b>	2400x1000x3mm	360	24	m <sup>2</sup> M6	<b>23,76</b>
--	---------------	-----	----	----------------------	--------------

## Uponor Klett Panel Silent

 <b>1088065</b>	1200x1000x30mm	48	4,8	m <sup>2</sup> M6	<b>61,62</b>
--	----------------	----	-----	----------------------	--------------

## Uponor Vario Verteilerplatte

 <b>1090043</b>	27mm	116	29	St. MZ	<b>60,59</b>
--	------	-----	----	-----------	--------------

## Uponor Vario Rohrführungsplatte

 <b>1090044</b>	27mm	116	29	St. MZ	<b>54,38</b>
--	------	-----	----	-----------	--------------

## Uponor Vario Verteilerpl. m. Trittschall

 <b>1091816</b>	32mm	100	25	St. MZ	<b>86,05</b>
--	------	-----	----	-----------	--------------

## Uponor Vario Rohrführung m. Trittschall

 <b>1091817</b>	32mm	100	25	St. MZ	<b>72,09</b>
--	------	-----	----	-----------	--------------

## Uponor Multi Randdämmstreifen mit Folie

 <b>1000079</b>	150x8mm	-	200	m MZ	<b>1,54</b>
Hinweis: Verkauf pro Verpackungseinheit.					

## Uponor Multi Randdämmstreifen Klebefolie

 <b>1000080</b>	150x10mm	-	200	m MZ	<b>3,15</b>
Hinweis: Verkauf pro Verpackungseinheit.					

## Uponor Multi PE Randdämmstreifen mit Klebefolie HB

 <b>1135494</b>	150x8mm	-	250	m MZ	<b>1,54</b>
Hinweis: Verkauf pro Verpackungseinheit.					

## Uponor Klett Randdämmstreifen

 <b>1089919</b>	1200x120x13mm	1536	96	m M6	<b>6,93</b>
--	---------------	------	----	---------	-------------

## Uponor Klett Abdichtstreifen

 <b>1089951</b>	50m 280x0,2mm	6000	50	m M6	<b>7,80</b>
--	---------------	------	----	---------	-------------

## Uponor Multi Dehnungsfugenprofil

 <b>1090229</b>	1800x100x10mm	720	18	m MZ	<b>14,47</b>
--	---------------	-----	----	---------	--------------

Art-Nr.	Dimension	LE	VE	ME RG	Preis/ME
 <b>1000082</b>	20mm 300x5mm	1800	30	St. MZ	<b>1,40</b>

## Uponor Klett Rohr

 <b>1088479</b>	14x2,0 240m	1440	240	m M6	<b>2,68</b>
<b>1088480</b>	14x2,0 640m	1280	640	m M6	<b>2,68</b>
<b>1087302</b>	16x2,0 240m	1200	240	m M6	<b>2,80</b>
<b>1087303</b>	16x2,0 640m	1280	640	m M6	<b>2,80</b>

## Uponor Vario Klemmringverschraubung PEX

 <b>1065283</b>	14x2,0-G $\frac{3}{4}$ "FT Euro	25	1	St. MZ	<b>8,06</b>
<b>1065284</b>	16x1,8/2,0-G $\frac{3}{4}$ "FT Euro	25	1	St. MZ	<b>8,06</b>

## Uponor Smart Presskupplung

 <b>1089646</b>	14x2,0-14x2,0	80	20	St. MZ	<b>12,02</b>
<b>1089647</b>	16x1,8/2,0-16x1,8/2,0	80	20	St. MZ	<b>13,61</b>

## Uponor Fit Schraubkupplung PEX

 <b>1065296</b>	16x1,8/2,0-16x1,8/2,0	25	1	St. MZ	<b>26,18</b>
--	-----------------------	----	---	-----------	--------------

## Uponor Klett Rohr MLCP RED

 <b>1096014</b>	16x2,0 240m	1920	240	m M6	<b>3,19</b>
<b>1096015</b>	16x2,0 480m	2400	480	m M6	<b>3,19</b>

## Uponor Uni-X Verschraubung MLC

 <b>1058090</b>	16- $\frac{3}{4}$ "FT Euro	25	1	St. D1	<b>9,41</b>
--	----------------------------	----	---	-----------	-------------

## Uponor S-Press PLUS Kupplung

 <b>1070547</b>	16-16	80	20	St. D1	<b>12,03</b>
--	-------	----	----	-----------	--------------

## Uponor Klett Klebeband spezial special

 <b>1007178</b>	20m 50mm	30	5	St. U1	<b>27,25</b>
--	----------	----	---	-----------	--------------

## Uponor Multi Klebeband

 <b>1000012</b>	66m 50mm	36	1	St. MZ	<b>8,44</b>
--	----------	----	---	-----------	-------------

## Uponor Multi Rohrführungsbogen

 <b>1135491</b>	14-18	240	30	St. D1	<b>3,88</b>
--	-------	-----	----	-----------	-------------

## Uponor Multi Rohrhalterung

 <b>1088066</b>		-	1	St. NET	<b>300,55</b>
--	--	---	---	------------	---------------

# Uponor Tacker

Art-Nr.	Dimension	LE	VE	ME RG	Preis/ME
 <b>1090921</b>	EPS DES 20-2mm 10x1m	100	10	m <sup>2</sup> M7	<b>11,87</b>
<b>1090924</b>	EPS DES 30-2mm 10x1m	80	10	m <sup>2</sup> M7	<b>14,19</b>
<b>1090925</b>	EPS DES 30-3mm 10x1m	80	10	m <sup>2</sup> M7	<b>12,93</b>
<b>1090926</b>	EPS DES 35-3mm 10x1m	70	10	m <sup>2</sup> M7	<b>14,31</b>
<b>1090927</b>	EPS DES 40-3mm 10x1m	60	10	m <sup>2</sup> M7	<b>15,56</b>

## Uponor Tacker Panel

 <b>1090917</b>	EPS DEO 20	100	10	m <sup>2</sup> M7	<b>12,55</b>
<b>1090918</b>	EPS DEO 30	80	10	m <sup>2</sup> M7	<b>22,84</b>

## Uponor Tacker Folie transparent

 <b>1122372</b>	0,2mm 100x1,03m	2884	103	m <sup>2</sup> M7	<b>5,08</b>
--	-----------------	------	-----	----------------------	-------------

## Uponor Multi Randdämmstreifen mit Folie

 <b>1000079</b>	150x8mm	-	200	m MZ	<b>1,54</b>
--	---------	---	-----	---------	-------------

Hinweis: Verkauf pro Verpackungseinheit.

## Uponor Multi Randdämmstreifen Klebefolie

 <b>1000080</b>	150x10mm	-	200	m MZ	<b>3,15</b>
---	----------	---	-----	---------	-------------

Hinweis: Verkauf pro Verpackungseinheit.

## Uponor Multi PE Randdämmstreifen mit Klebefolie HB

 <b>1135494</b>	150x8mm	-	250	m MZ	<b>1,54</b>
--	---------	---	-----	---------	-------------

Hinweis: Verkauf pro Verpackungseinheit.

## Uponor Multi Dehnungsfugenprofil

 <b>1090229</b>	1800x100x10mm	720	18	m MZ	<b>14,47</b>
--	---------------	-----	----	---------	--------------

## Uponor Multi Schutzhülse

 <b>1000082</b>	20mm 300x5mm	1800	30	St. MZ	<b>1,40</b>
--	--------------	------	----	-----------	-------------

## Uponor Multi Klebeband

 <b>1000012</b>	66m 50mm	36	1	St. MZ	<b>8,44</b>
--	----------	----	---	-----------	-------------

## Uponor Comfort Pipe Rohr

 <b>1047622</b>	16x1,8 240m	1440	240	m M1	<b>1,74</b>
<b>1047623</b>	16x1,8 640m	1280	640	m M1	<b>1,74</b>

## Uponor Comfort Pipe PLUS Blue Rohr

 <b>1126541</b>	16x2,0 640m	640	640	m M0	<b>4,34</b>
--	-------------	-----	-----	---------	-------------

## Uponor Vario Klemmringverschraubung PEX

 <b>1065284</b>	16x1,8/2,0-G $\frac{3}{4}$ "FT Euro	25	1	St. MZ	<b>8,06</b>
--	-------------------------------------	----	---	-----------	-------------

Art-Nr.	Dimension	LE	VE	ME RG	Preis/ME
 <b>1065296</b>	16x1,8/2,0-16x1,8/2,0	25	1	St. MZ	<b>26,18</b>

## Uponor Smart Presskupplung

 <b>1089647</b>	16x1,8/2,0-16x1,8/2,0	80	20	St. MZ	<b>13,61</b>
--	-----------------------	----	----	-----------	--------------

## Uponor MLCP RED Rohr

 <b>1096010</b>	14x1,6 240m	3120	240	m M1	<b>2,07</b>
<b>1096011</b>	14x1,6 480m	3360	480	m M1	<b>2,07</b>
<b>1096012</b>	16x2,0 240m	3120	240	m M1	<b>2,58</b>
<b>1096013</b>	16x2,0 480m	3360	480	m M1	<b>2,58</b>

## Uponor Vario Eurokonusverschraubung MLCP Red

 <b>1000117</b>	14x1,6- $\frac{3}{4}$ "Euro	80	20	St. MZ	<b>6,96</b>
--	-----------------------------	----	----	-----------	-------------

## Uponor MLCP Red Press-Kupplung

 <b>1048272</b>	14x1,6-14x1,6	80	20	St. MZ	<b>12,87</b>
--	---------------	----	----	-----------	--------------

## Uponor Uni-X Verschraubung MLC

 <b>1058090</b>	16- $\frac{3}{4}$ "FT Euro	25	1	St. D1	<b>9,41</b>
---	----------------------------	----	---	-----------	-------------

## Uponor S-Press PLUS Kupplung

 <b>1070547</b>	16-16	80	20	St. D1	<b>12,03</b>
--	-------	----	----	-----------	--------------

## Uponor S-Press PLUS Kupplung PPSU

 <b>1039933</b>	16-16	80	20	St. E1	<b>7,56</b>
--	-------	----	----	-----------	-------------

## Uponor Tacker Tackernadel kurz set = 300pce

 <b>NEU 1140123</b>	14-17mm h=35mm	28	1	Set M7	<b>55,24</b>
--	----------------	----	---	-----------	--------------

## Uponor Tacker Nadel set = 1000pce

 <b>NEU 1140159</b>	14-20mm h=40mm	8	1	Set M7	<b>81,84</b>
--	----------------	---	---	-----------	--------------

## Uponor Tacker Tackernadel lang set = 250pce

 <b>NEU 1140124</b>	14-20mm h=50mm	20	1	Set M7	<b>94,63</b>
--	----------------	----	---	-----------	--------------

## Uponor Tacker Werkzeug

 <b>1119039</b>	14-20mm	50	1	St. NET	<b>280,97</b>
--	---------	----	---	------------	---------------

## Uponor Multi Rohrführungsbogen

 <b>1135491</b>	14-18	240	30	St. D1	<b>3,88</b>
<b>1135492</b>	20-22	140	35	St. D1	<b>4,78</b>

# Uponor Classic

Art-Nr.	Dimension	LE	VE	ME RG	Preis/ME
<b>Uponor Classic Stahlmatte beschichtet</b>					
 <b>1005085</b>	50mm 2150x750x3mm	483,7	16,1	m <sup>2</sup> M5	<b>29,00</b>
<b>1005084</b>	100mm 2100x1200x3mm	25,2	1	m <sup>2</sup> M5	<b>13,21</b>
<b>1005087</b>	150mm 2100x1200x3mm	756	25,2	m <sup>2</sup> M5	<b>10,98</b>

## Uponor Classic Stahlmatte

 <b>1063406</b>	100mm 2100x1200x3mm	756	25,2	m <sup>2</sup> M5	<b>10,46</b>
<b>1063407</b>	150mm 2100x1200x3mm	756	25,2	m <sup>2</sup> M5	<b>7,46</b>

## Uponor Classic Mattenbinder

 <b>1007393</b>	80mm (100pce/set)	2500	50	Set M5	<b>5,51</b>
--	-------------------	------	----	-----------	-------------

## Uponor Classic Rohrhälter für Stahlmatte

 <b>1005188</b>	16mm 3mm	5000	500	St. M5	<b>0,44</b>
<b>1005189</b>	17mm 3mm	5000	500	St. M5	<b>0,44</b>
<b>1005190</b>	20mm 3mm	2800	280	St. M5	<b>0,64</b>

## Uponor Multi Randdämmstreifen mit Folie

 <b>1000079</b>	150x8mm	-	200	m MZ	<b>1,54</b>
Hinweis: Verkauf pro Verpackungseinheit.					

## Uponor Multi Randdämmstreifen Klebefolie

 <b>1000080</b>	150x10mm	-	200	m MZ	<b>3,15</b>
Hinweis: Verkauf pro Verpackungseinheit.					

## Uponor Multi PE Randdämmstreifen mit Klebefolie HB

 <b>1135494</b>	150x8mm	-	250	m MZ	<b>1,54</b>
Hinweis: Verkauf pro Verpackungseinheit.					

## Uponor Multi Dehnungsfugenprofil

 <b>1090229</b>	1800x100x10mm	720	18	m MZ	<b>14,47</b>
--	---------------	-----	----	---------	--------------

## Uponor Multi Schutzhülse

 <b>1000082</b>	20mm 300x5mm	1800	30	St. MZ	<b>1,40</b>
--	--------------	------	----	-----------	-------------

## Uponor Comfort Pipe PLUS Blue Rohr

 <b>1126541</b>	16x2,0 640m	640	640	m M0	<b>4,34</b>
<b>1126542</b>	20x2,0 480m	480	480	m M0	<b>5,23</b>

## Uponor Comfort Pipe PLUS Rohr

 <b>1034535</b>	17x2,0 120m	840	120	m M0	<b>3,64</b>
<b>1009226</b>	17x2,0 240m	1200	240	m M0	<b>3,64</b>
<b>1086340</b>	17x2,0 480m	960	480	m M0	<b>3,64</b>
<b>1009227</b>	17x2,0 640m	1280	640	m M0	<b>3,64</b>

Art-Nr.	Dimension	LE	VE	ME RG	Preis/ME
<b>Uponor Magna pipe PLUS</b>					
 <b>1091275</b>	20x2,0 240m	960	240	m B7	<b>3,73</b>
<b>1091276</b>	20x2,0 480m	960	480	m B7	<b>3,73</b>

## Uponor Vario Klemmringverschraubung PEX

 <b>1065284</b>	16x1,8/2,0-G¾"FT Euro	25	1	St. MZ	<b>8,06</b>
<b>1065286</b>	17x2,0-G¾"FT Euro	25	1	St. MZ	<b>8,06</b>
<b>1065290</b>	20x1,9/2,0-G¾"FT Euro	25	1	St. MZ	<b>8,42</b>

## Uponor Fit Schraubkupplung PEX

 <b>1065296</b>	16x1,8/2,0-16x1,8/2,0	25	1	St. MZ	<b>26,18</b>
<b>1065299</b>	17x2,0-17x2,0	25	1	St. MZ	<b>24,88</b>
<b>1065302</b>	20x1,9/2,0-20x1,9/2,0	25	1	St. MZ	<b>40,30</b>

## Uponor Smart Presskupplung

 <b>1089647</b>	16x1,8/2,0-16x1,8/2,0	80	20	St. MZ	<b>13,61</b>
<b>1089648</b>	20x2,0-20x2,0	80	20	St. MZ	<b>15,18</b>

## Uponor Rapex Press-Kupplung

 <b>1005079</b>	17-17	100	10	St. MZ	<b>15,97</b>
---	-------	-----	----	-----------	--------------

## Uponor Multi Rohrführungsbogen

 <b>1135491</b>	14-18	240	30	St. D1	<b>3,88</b>
<b>1135492</b>	20-22	140	35	St. D1	<b>4,78</b>















## Uponor Classic clipmaster











 <b>1006295</b>	16/17mm l=920mm	100	1	St. NET	<b>341,43</b>
<b>1006309</b>	20mm l=920mm	-	1	St. NET	<b>497,70</b>

## Uponor Classic Drillgerät f. Mattenbinder

 <b>1006243</b>	l=320mm	50	1	St. NET	<b>26,79</b>
--	---------	----	---	------------	--------------

# Uponor Siccus Mini

Art-Nr.	Dimension	LE	VE	ME RG	Preis/ME
<b>Uponor Siccus Mini Panel</b>					
 <b>NEU</b> 1122381	1200x600x15mm	144	7,2	m <sup>2</sup> M3	64,71
<b>Uponor Siccus Mini Fliesenträgerpanel</b>					
 <b>NEU</b> 1139793	1000x600x6mm	90	3	m <sup>2</sup> M3	52,36
<b>Uponor Siccus Mini Randverstärkung</b>					
 <b>NEU</b> 1139794	1000x45x15mm	800	10	m M3	15,93
<b>Uponor Siccus Mini Fugenverstärkungsband</b>					
 <b>NEU</b> 1139795	143mm 12m	3360	24	m M3	6,72
<b>Uponor Minitec Randdämmstreifen klebend</b>					
 1005267	20m 80x8mm	-	200	m M <sup>2</sup>	1,94
<b>Uponor Minitec Bewegungsfugenprofil</b>					
 1085980	0,9m 40x10mm	600	10	St. M <sup>2</sup>	12,82
1085981	1,3m 40x10mm	600	10	St. M <sup>2</sup>	16,25
<b>Uponor Comfort Pipe Rohr Minitec</b>					
 1063288	9,9x1,1 120m	1680	120	m M <sup>2</sup>	4,20
1063289	9,9x1,1 240m	2640	240	m M <sup>2</sup>	4,20
1063381	9,9x1,1 480m	2880	480	m M <sup>2</sup>	4,20
<b>Uponor Minitec Eurokonusverschraubung</b>					
 1005266	9,9x1,1-G $\frac{3}{4}$ "Euro	100	10	St. M <sup>2</sup>	13,21
<b>Uponor Minitec Kupplung</b>					
 1005264	9,9x1,1	100	10	St. M <sup>2</sup>	11,45
<b>Uponor Minitec Übergangsnippel</b>					
 1005265	9,9-R $\frac{1}{2}$ "MT	100	10	St. M <sup>2</sup>	14,05
<b>Uponor Minitec Ring</b>					
 1005263	9,9x1,1	1600	10	St. M <sup>2</sup>	0,76
<b>Uponor Minitec Klemmringverschraubung</b>					
 1013426	9,9- $\frac{3}{4}$ "Euro	120	12	St. M <sup>2</sup>	22,14
<b>Uponor Minitec Schraubkupplung</b>					
 1016690	9,9-9,9	48	12	St. M <sup>2</sup>	52,66
<b>Uponor Fluvia Hosenstück</b>					
 1005675	2xG $\frac{3}{4}$ - $\frac{3}{4}$ "Euro	50	1	Set MZ	62,46

Art-Nr.	Dimension	LE	VE	ME RG	Preis/ME
<b>Uponor Fluvia T Pumpengruppe Push-12 TH-G</b>					
 1095127		60	1	St. MZ	812,99
<b>Uponor Fluvia T Pumpengruppe Push-12 CH-G</b>					
 1095131		30	1	St. MZ	1913,91
<b>Uponor Fluvia T Pumpengruppe Push-12 AC-G</b>					
 1095128		60	1	St. MZ	964,13
<b>Uponor Vario Füll / Entleerungshahn</b>					
 1061802	$\frac{3}{4}$ " - $\frac{3}{4}$ "	10	1	Set MZ	77,55
<b>Uponor Multi Rohrführungsbogen</b>					
 1135490	10-12	360	60	St. D1	1,51
<b>Uponor Minitec Anschlussbox-UP</b>					
 1005270	1x	30	1	St. M <sup>2</sup>	412,16
1005271	2x	-	1	St. M <sup>2</sup>	577,04
1005272	3x	-	1	St. M <sup>2</sup>	609,10
Die Begrenzung der Auslegungstemperatur muss durch eine Vorregelung sichergestellt sein.					
<b>Uponor Minitec Abdeckplatte</b>					
 1007251		-	1	St. M <sup>2</sup>	167,94
<b>Uponor Base Raumfühler T-23 standard</b>					
 1058422	230V RAL9010	160	1	St. MZ	58,57
<b>Uponor Minitec Aufweitwerkzeug</b>					
 1006247	9,9x1,1	11	1	Set NET	399,92
<b>Uponor Q&amp;E Aufweitwerkzeug mit Aufweitk. M12/</b>					
 1119375	6bar 9,9RS/20	-	1	Set NET	702,82
<b>Uponor Siccus Mini Heißschneidergerät</b>					
 <b>NEU</b> 1139796	10mm 230V	20	1	St. NET	440,09

# Uponor Siccus 14

Art-Nr.	Dimension	LE	VE	ME RG	Preis/ME
---------	-----------	----	----	----------	----------

## Uponor Siccus 14 Verlegeplatte

 <b>1005485</b>	EPS 150kPa 14mm 1197x1050x25mm	100	12,5	$\frac{m^2}{M3}$	<b>21,39</b>
--	-----------------------------------	-----	------	------------------	--------------

## Uponor Siccus 14 Wärmeleitlamelle

 <b>1005486</b>	14mm 1180x120x0,45mm	768	48	$\frac{St.}{M3}$	<b>8,35</b>
--	----------------------	-----	----	------------------	-------------

## Uponor Multi Folie PE

 <b>1005049</b>	0,2mm 60x1,25m	3375	75	$\frac{m^2}{MZ}$	<b>2,16</b>
--	----------------	------	----	------------------	-------------

Hinweis: Verkauf pro Verpackungseinheit von 1 Rolle

## Uponor Comfort Pipe PLUS Rohr

 <b>1062883</b>	14x2,0 120m	1320	120	$\frac{m}{M0}$	<b>3,47</b>
<b>1062884</b>	14x2,0 240m	1680	240	$\frac{m}{M0}$	<b>3,47</b>
<b>1088166</b>	14x2,0 640m	1920	640	$\frac{m}{M0}$	<b>3,47</b>
<b>1062885</b>	14x2,0 960m	1920	960	$\frac{m}{M0}$	<b>3,47</b>

## Uponor Vario Klemmringverschraubung PEX

 <b>1065283</b>	14x2,0-G $\frac{3}{4}$ "FT Euro	25	1	$\frac{St.}{MZ}$	<b>8,06</b>
--	---------------------------------	----	---	------------------	-------------

## Uponor Smart Presskupplung

 <b>1089646</b>	14x2,0-14x2,0	80	20	$\frac{St.}{MZ}$	<b>12,02</b>
--	---------------	----	----	------------------	--------------

Art-Nr.	Dimension	LE	VE	ME RG	Preis/ME
---------	-----------	----	----	----------	----------

## Uponor MLCP RED Rohr

 <b>1096010</b>	14x1,6 240m	3120	240	$\frac{m}{M1}$	<b>2,07</b>
<b>1096011</b>	14x1,6 480m	3360	480	$\frac{m}{M1}$	<b>2,07</b>

## Uponor Vario Eurokonusverschraubung MLCP Red

 <b>1000117</b>	14x1,6- $\frac{3}{4}$ "Euro	80	20	$\frac{St.}{MZ}$	<b>6,96</b>
--	-----------------------------	----	----	------------------	-------------

## Uponor MLCP Red Press-Kupplung

 <b>1048272</b>	14x1,6-14x1,6	80	20	$\frac{St.}{MZ}$	<b>12,87</b>
--	---------------	----	----	------------------	--------------

## Uponor Multi Randdämmstreifen mit Folie

 <b>1000079</b>	150x8mm	-	200	$\frac{m}{MZ}$	<b>1,54</b>
--	---------	---	-----	----------------	-------------

Hinweis: Verkauf pro Verpackungseinheit.

## Uponor Multi PE Randdämmstreifen mit Klebefolie HB

 <b>1135494</b>	150x8mm	-	250	$\frac{m}{MZ}$	<b>1,54</b>
--	---------	---	-----	----------------	-------------

Hinweis: Verkauf pro Verpackungseinheit.

## Uponor Multi Rohrführungsbogen

 <b>1135491</b>	14-18	240	30	$\frac{St.}{D1}$	<b>3,88</b>
---	-------	-----	----	------------------	-------------

## Uponor Siccus Sport Stahlblechabdeckung

 <b>1085610</b>	204m <sup>2</sup> , 0,6x1000x2000mm	-	204	$\frac{m^2}{M3}$	<b>50,15</b>
--	-------------------------------------	---	-----	------------------	--------------

## Uponor Siccus 14 Schneidegerät

 <b>1006290</b>	14mm 230V	-	1	$\frac{St.}{NET}$	<b>279,13</b>
--	-----------	---	---	-------------------	---------------

## Uponor Siccus 14 Schneideinsatz

 <b>1006291</b>	14	-	1	$\frac{St.}{U1}$	<b>271,68</b>
--	----	---	---	------------------	---------------

# Uponor Renovis

Art-Nr.	Dimension	LE	VE	ME RG	Preis/ME
 <b>1061173</b>	800x625mm	24	1	St. MR	<b>118,63</b>
<b>1061172</b>	1200x625mm	24	1	St. MR	<b>160,26</b>
<b>1061171</b>	2000x625mm	24	1	St. MR	<b>180,12</b>

## Uponor Renovis Panel extra

 <b>1063923</b>	800x625x15mm	24	1	St. MR	<b>132,20</b>
<b>1063924</b>	1200x625x15mm	24	1	St. MR	<b>166,40</b>
<b>1063925</b>	2000x625x15mm	24	1	St. MR	<b>199,99</b>

## Uponor Renovis Panel

 <b>1063926</b>	2000x625x15mm	-	24	St. MR	<b>45,81</b>
--	---------------	---	----	-----------	--------------

## Uponor Renovis Anschlusset

 <b>1061165</b>	4-6x	10	1	Set MR	<b>642,69</b>
--	------	----	---	-----------	---------------

## Uponor Fix Klemmschiene

 <b>1005274</b>	9,9mm c/c20mm 2,5m	25	2,5	m M²	<b>7,36</b>
--	--------------------	----	-----	---------	-------------

## Uponor Renovis Klemmschiene

 <b>1061162</b>	20mm l=250mm	-	15	St. MR	<b>6,53</b>
--	--------------	---	----	-----------	-------------

## Uponor Comfort Pipe Rohr Minitec

 <b>1063287</b>	9,9x1,1 60m	840	60	m M²	<b>4,20</b>
<b>1063288</b>	9,9x1,1 120m	1680	120	m M²	<b>4,20</b>

## Uponor Minitec Übergangsnippel

 <b>1005265</b>	9,9-R1/2"MT	100	10	St. M²	<b>14,05</b>
--	-------------	-----	----	-----------	--------------

## Uponor Minitec Kupplung

 <b>1005264</b>	9,9x1,1	100	10	St. M²	<b>11,45</b>
--	---------	-----	----	-----------	--------------

## Uponor Minitec Ring

 <b>1005263</b>	9,9x1,1	1600	10	St. M²	<b>0,76</b>
--	---------	------	----	-----------	-------------

## Uponor Comfort Pipe PLUS Rohr

 <b>1009229</b>	20x2,0 60m	660	60	m M0	<b>3,70</b>
--	------------	-----	----	---------	-------------

## Uponor Magna pipe PLUS

 <b>1091275</b>	20x2,0 240m	960	240	m B7	<b>3,73</b>
<b>1091276</b>	20x2,0 480m	960	480	m B7	<b>3,73</b>

## Uponor Q&E T-Stück reduziert Minitec

 <b>1020524</b>	20xMinitec9,9xQ&E20	75	5	St. MZ	<b>16,55</b>
--	---------------------	----	---	-----------	--------------

## Uponor Q&E Kupplung red. Minitec

 <b>1020518</b>	20xMinitec9,9	150	5	St. MZ	<b>18,56</b>
--	---------------	-----	---	-----------	--------------

Art-Nr.	Dimension	LE	VE	ME RG	Preis/ME
 <b>1008932</b>	20-20	80	5	St. F1	<b>6,17</b>

## Uponor Q&E Winkel PPSU

 <b>1008680</b>	20-20	40	5	St. F1	<b>8,21</b>
--	-------	----	---	-----------	-------------

## Uponor Q&E Sicherungsring white

 <b>1057454</b>	20	520	20	St. F1	<b>0,68</b>
--	----	-----	----	-----------	-------------

## Uponor Uni Pipe PLUS weiß S

 <b>1060784</b>	20x2,25 3m	51	3	m E1	<b>10,76</b>
--	------------	----	---	---------	--------------

## Uponor Q&E T-Stück Übergang S-Press

 <b>1063938</b>	20-Q&E9,9-Press20	6	2	St. D1	<b>16,72</b>
--	-------------------	---	---	-----------	--------------

## Uponor Q&E Übergang S-Press

 <b>1063939</b>	20-Q&E9,9	12	2	St. D1	<b>13,37</b>
--	-----------	----	---	-----------	--------------

## Uponor Vario VL-Feinregulierventil

 <b>1005107</b>	1/2" - G3/4	50	1	St. MZ	<b>40,92</b>
--	-------------	----	---	-----------	--------------

## Uponor Vario RL-Ventil

 <b>1005108</b>	1/2" - G3/4	50	1	St. MZ	<b>34,89</b>
--	-------------	----	---	-----------	--------------

## Uponor Vario PLUS Thermoantrieb NC

 <b>1005605</b>	230V MT30x1,5	10	1	St. MZ	<b>84,18</b>
--	---------------	----	---	-----------	--------------

Lieferung solange Vorrat reicht. Artikel läuft im Laufe des Jahres aus.

## Uponor Vario PLUS Stellantrieb NC

 <b>1141678</b>	MT 230V 1W IP54	100	1	St. MZ	<b>62,08</b>
--	-----------------	-----	---	-----------	--------------

## Uponor Base Raumfühler T-23 standard

 <b>1058422</b>	230V RAL9010	160	1	St. MZ	<b>58,57</b>
--	--------------	-----	---	-----------	--------------

## Uponor Multi Rohrführungsbogen

 <b>1135490</b>	10-12	360	60	St. D1	<b>1,51</b>
--	-------	-----	----	-----------	-------------

## Uponor Minitec Aufweitwerkzeug

 <b>1006247</b>	9,9x1,1	11	1	Set NET	<b>399,92</b>
--	---------	----	---	------------	---------------

## Uponor Q&E Aufweitwerkzeug mit Aufweitk. M12/

 <b>1119375</b>	6bar 9,9RS/20	-	1	Set NET	<b>702,82</b>
--	---------------	---	---	------------	---------------

# Uponor Teporis

Art-Nr.	Dimension	LE	VE	ME RG	Preis/ME
<b>Uponor Teporis Panel aktiv</b>					
 <b>1047319</b>	2000x1200mm	25	1	St. B6	<b>753,04</b>
<b>1047320</b>	1000x1200mm	50	1	St. B6	<b>391,02</b>
<b>1047321</b>	500x1200mm	100	1	St. B6	<b>196,99</b>

<b>Uponor Teporis Panel passiv</b>					
 <b>1020506</b>	2000x1200mm	-	25	St. B6	<b>316,17</b>

<b>Uponor Comfort Pipe Rohr Minitec</b>					
 <b>1063287</b>	9,9x1,1 60m	840	60	m M²	<b>4,20</b>
<b>1063288</b>	9,9x1,1 120m	1680	120	m M²	<b>4,20</b>

<b>Uponor Minitec Kupplung</b>					
 <b>1005264</b>	9,9x1,1	100	10	St. M²	<b>11,45</b>

<b>Uponor Minitec Ring</b>					
 <b>1005263</b>	9,9x1,1	1600	10	St. M²	<b>0,76</b>

<b>Uponor Minitec Übergangsnippel</b>					
 <b>1005265</b>	9,9-R½"MT	100	10	St. M²	<b>14,05</b>

<b>Uponor Comfort Pipe PLUS Rohr</b>					
 <b>1009229</b>	20x2,0 60m	660	60	m M0	<b>3,70</b>

<b>Uponor Magna pipe PLUS</b>					
 <b>1091275</b>	20x2,0 240m	960	240	m B7	<b>3,73</b>
<b>1091276</b>	20x2,0 480m	960	480	m B7	<b>3,73</b>

<b>Uponor Q&amp;E T-Stück reduziert Minitec</b>					
 <b>1020524</b>	20xMinitec9,9xQ&E20	75	5	St. MZ	<b>16,55</b>

<b>Uponor Q&amp;E Kupplung red. Minitec</b>					
 <b>1020518</b>	20xMinitec9,9	150	5	St. MZ	<b>18,56</b>

<b>Uponor Q&amp;E Sicherungsring white</b>					
 <b>1057454</b>	20	520	20	St. F1	<b>0,68</b>
<b>1057455</b>	25	300	20	St. F1	<b>1,31</b>

<b>Uponor Vario Klemmringverschraubung PEX</b>					
 <b>1065290</b>	20x1,9/2,0-G¾"FT Euro	25	1	St. MZ	<b>8,42</b>

Art-Nr.	Dimension	LE	VE	ME RG	Preis/ME
<b>Uponor Uni Pipe PLUS weiß S</b>					
 <b>1060784</b>	20x2,25 3m	51	3	m E1	<b>10,76</b>

<b>Uponor Q&amp;E T-Stück Übergang S-Press</b>					
 <b>1063938</b>	20-Q&E9,9-Press20	6	2	St. D1	<b>16,72</b>

<b>Uponor Q&amp;E Übergang S-Press</b>					
 <b>1063939</b>	20-Q&E9,9	12	2	St. D1	<b>13,37</b>

<b>Uponor Fix Klemmschiene</b>					
 <b>1005274</b>	9,9mm c/c20mm 2,5m	25	2,5	m M²	<b>7,36</b>

<b>Uponor Multi Rohrführungsbogen</b>					
 <b>1135490</b>	10-12	360	60	St. D1	<b>1,51</b>

<b>Uponor Minitec Aufweitwerkzeug</b>					
 <b>1006247</b>	9,9x1,1	11	1	Set NET	<b>399,92</b>

<b>Uponor Q&amp;E Aufweitwerkzeug mit Aufweitk. M12/</b>					
 <b>1119375</b>	6bar 9,9RS/20	-	1	Set NET	<b>702,82</b>

# Uponor ThermoTop Deckensystem

Art-Nr.	Dimension	LE	VE	ME RG	Preis/ME
---------	-----------	----	----	----------	----------

## Uponor ThermoTop M



1090933	950x277mm	200	10	St. I6	72,69
1090934	1350x277mm	200	10	St. I6	102,18
1090935	1750x277mm	200	10	St. I6	131,66
1090936	2150x277mm	200	10	St. I6	164,91
1090937	2550x277mm	200	10	St. I6	193,95

Art-Nr.	Dimension	LE	VE	ME RG	Preis/ME
---------	-----------	----	----	----------	----------

## Uponor Uni-X Verschraubung MLC



1058090	16-3/4"FT Euro	25	1	St. D1	9,41
---------	----------------	----	---	-----------	------

## Uponor S-Press PLUS Kupplung



1070547	16-16	80	20	St. D1	12,03
---------	-------	----	----	-----------	-------

## Uponor S-Press PLUS Kupplung PPSU



1039933	16-16	80	20	St. E1	7,56
---------	-------	----	----	-----------	------

### Verbindungstechnik: Uponor S-Press PLUS

Verbindungstechnik: die einzelnen Module können mit der üblichen Verbindungstechnik Uponor S-Press verbunden werden

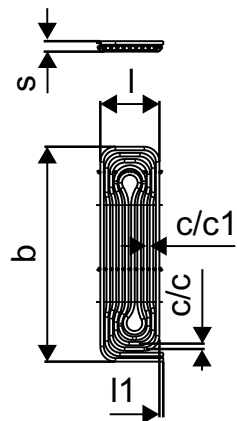



# Uponor Siccus Wall

Art-Nr.	Dimension	LE	VE	ME RG	Preis/ME
---------	-----------	----	----	----------	----------

## Uponor Siccus 14 Verlegeplatte

 <b>1005485</b>	EPS 150kPa 14mm 1197x1050x25mm	100	12,5	$\frac{m^2}{M3}$	<b>21,39</b>
--	-----------------------------------	-----	------	------------------	--------------

## Uponor Siccus 14 Wärmeleitlamelle

 <b>1005486</b>	14mm 1180x120x0,45mm	768	48	$\frac{St.}{M3}$	<b>8,35</b>
--	----------------------	-----	----	------------------	-------------

## Uponor Comfort Pipe PLUS Rohr

 <b>1062883</b>	14x2,0 120m	1320	120	$\frac{m}{M0}$	<b>3,47</b>
<b>1062884</b>	14x2,0 240m	1680	240	$\frac{m}{M0}$	<b>3,47</b>
<b>1062885</b>	14x2,0 960m	1920	960	$\frac{m}{M0}$	<b>3,47</b>

## Uponor Vario Klemmringverschraubung PEX

 <b>1065283</b>	14x2,0-G $\frac{3}{4}$ "FT Euro	25	1	$\frac{St.}{M2}$	<b>8,06</b>
--	---------------------------------	----	---	------------------	-------------

## Uponor Smart Presskupplung

 <b>1089646</b>	14x2,0-14x2,0	80	20	$\frac{St.}{M2}$	<b>12,02</b>
--	---------------	----	----	------------------	--------------

Art-Nr.	Dimension	LE	VE	ME RG	Preis/ME
---------	-----------	----	----	----------	----------

## Uponor MLCP RED Rohr

 <b>1096010</b>	14x1,6 240m	3120	240	$\frac{m}{M1}$	<b>2,07</b>
<b>1096011</b>	14x1,6 480m	3360	480	$\frac{m}{M1}$	<b>2,07</b>

## Uponor Vario Eurokonusverschraubung MLCP Red

 <b>1000117</b>	14x1,6- $\frac{3}{4}$ "Euro	80	20	$\frac{St.}{M2}$	<b>6,96</b>
--	-----------------------------	----	----	------------------	-------------

## Uponor MLCP Red Press-Kupplung

 <b>1048272</b>	14x1,6-14x1,6	80	20	$\frac{St.}{M2}$	<b>12,87</b>
--	---------------	----	----	------------------	--------------

## Uponor Siccus 14 Schneidegerät

 <b>1006290</b>	14mm 230V	-	1	$\frac{St.}{NET}$	<b>279,13</b>
--	-----------	---	---	-------------------	---------------

# Uponor Fix

Art-Nr.	Dimension	LE	VE	ME RG	Preis/ME
 <b>1135496</b>	16-20mm c/c 50mm 1m	2000	100	St. M3	<b>7,23</b>

## Uponor Fix Klemmschiene

 <b>1005498</b>	14mm c/c50mm 2,5m	-	25	m M3	<b>5,84</b>
--	-------------------	---	----	---------	-------------

## Uponor Fix Klemmschiene

 <b>1005274</b>	9,9mm c/c20mm 2,5m	25	2,5	m M²	<b>7,36</b>
--	--------------------	----	-----	---------	-------------

## Uponor Comfort Pipe PLUS Rohr

 <b>1062883</b>	14x2,0 120m	1320	120	m M0	<b>3,47</b>
<b>1062884</b>	14x2,0 240m	1680	240	m M0	<b>3,47</b>
<b>1062885</b>	14x2,0 960m	1920	960	m M0	<b>3,47</b>
<b>1009229</b>	20x2,0 60m	660	60	m M0	<b>3,70</b>

## Uponor Comfort Pipe Rohr Minitec

 <b>1063287</b>	9,9x1,1 60m	840	60	m M²	<b>4,20</b>
<b>1063288</b>	9,9x1,1 120m	1680	120	m M²	<b>4,20</b>
<b>1063381</b>	9,9x1,1 480m	2880	480	m M²	<b>4,20</b>

## Uponor Magna pipe PLUS

 <b>1091275</b>	20x2,0 240m	960	240	m B7	<b>3,73</b>
<b>1091276</b>	20x2,0 480m	960	480	m B7	<b>3,73</b>

## Uponor Vario Klemmringverschraubung PEX

 <b>1065283</b>	14x2,0-G¾"FT Euro	25	1	St. MZ	<b>8,06</b>
<b>1065290</b>	20x1,9/2,0-G¾"FT Euro	25	1	St. MZ	<b>8,42</b>

## Uponor Smart Presskupplung

 <b>1089646</b>	14x2,0-14x2,0	80	20	St. MZ	<b>12,02</b>
--	---------------	----	----	-----------	--------------

## Uponor Q&E Sicherungsring white

 <b>1057454</b>	20	520	20	St. F1	<b>0,68</b>
--	----	-----	----	-----------	-------------

## Uponor MLCP RED Rohr

 <b>1096010</b>	14x1,6 240m	3120	240	m M1	<b>2,07</b>
<b>1096011</b>	14x1,6 480m	3360	480	m M1	<b>2,07</b>

## Uponor Vario Eurokonusverschraubung MLCP Red

 <b>1000117</b>	14x1,6-¾"Euro	80	20	St. MZ	<b>6,96</b>
--	---------------	----	----	-----------	-------------

## Uponor MLCP Red Press-Kupplung

 <b>1048272</b>	14x1,6-14x1,6	80	20	St. MZ	<b>12,87</b>
--	---------------	----	----	-----------	--------------

Art-Nr.	Dimension	LE	VE	ME RG	Preis/ME
 <b>1135494</b>	150x8mm	-	250	m MZ	<b>1,54</b>

Hinweis: Verkauf pro Verpackungseinheit.

## Uponor Minitec Ring

 <b>1005263</b>	9,9x1,1	1600	10	St. M²	<b>0,76</b>
--	---------	------	----	-----------	-------------

## Uponor Minitec Eurokonusverschraubung

 <b>1005266</b>	9,9x1,1-G¾"Euro	100	10	St. M²	<b>13,21</b>
--	-----------------	-----	----	-----------	--------------

## Uponor Minitec Kupplung

 <b>1005264</b>	9,9x1,1	100	10	St. M²	<b>11,45</b>
--	---------	-----	----	-----------	--------------

## Uponor Q&E T-Stück reduziert Minitec

 <b>1020524</b>	20xMinitec9,9xQ&E20	75	5	St. MZ	<b>16,55</b>
--	---------------------	----	---	-----------	--------------

## Uponor Minitec Übergangsnippel

 <b>1005265</b>	9,9-R½"MT	100	10	St. M²	<b>14,05</b>
--	-----------	-----	----	-----------	--------------

## Uponor Q&E Kupplung red. Minitec

 <b>1020518</b>	20xMinitec9,9	150	5	St. MZ	<b>18,56</b>
--	---------------	-----	---	-----------	--------------

## Uponor Minitec Aufweitwerkzeug

 <b>1006247</b>	9,9x1,1	11	1	Set NET	<b>399,92</b>
--	---------	----	---	------------	---------------

## Uponor Q&E Aufweitwerkzeug mit Aufweitk. M12/

 <b>1119375</b>	6bar 9,9RS/20	-	1	Set NET	<b>702,82</b>
--	---------------	---	---	------------	---------------

## Uponor Multi Rohrführungsbogen

 <b>1135490</b>	10-12	360	60	St. D1	<b>1,51</b>
--	-------	-----	----	-----------	-------------

## Uponor Multi Rohrführungsbogen

 <b>1135491</b>	14-18	240	30	St. D1	<b>3,88</b>
<b>1135492</b>	20-22	140	35	St. D1	<b>4,78</b>

# Uponor Multi – Zubehör Fußbodenaufbau

Art-Nr.	Dimension	LE	VE	ME RG	Preis/ME
 <b>1005372</b>	300mm	6000	100	St. B7	<b>0,36</b>
<b>1086531</b>	200mm	10000	100	St. B7	<b>0,24</b>

Hinweis: Verkauf pro Verpackungseinheit.

## Uponor Multi Klemmschiene

 <b>1005358</b>	20mm c/c50mm 3m	30	3	m B3	<b>10,23</b>
--	-----------------	----	---	---------	--------------

## Uponor Multi Dampfsperre PE

 <b>1005069</b>	3/300 3,3mm 40x1,25m	250	50	m <sup>2</sup> MZ	<b>12,20</b>
--	----------------------	-----	----	----------------------	--------------

## Uponor Multi Dicht- und Klebeband PE 3/300

 <b>1005071</b>	15m	8	1	St. MZ	<b>79,30</b>
--	-----	---	---	-----------	--------------

## Uponor Multi Folie PE

 <b>1005051</b>	0,1mm 75x2m	6900	150	m <sup>2</sup> MZ	<b>1,41</b>
--	-------------	------	-----	----------------------	-------------

## Uponor Multi Folie PE

 <b>1005049</b>	0,2mm 60x1,25m	3375	75	m <sup>2</sup> MZ	<b>2,16</b>
---	----------------	------	----	----------------------	-------------

Hinweis: Verkauf pro Verpackungseinheit von 1 Rolle

## Uponor Multi Foliendübel

 <b>1000016</b>	l=25mm	5000	100	St. MZ	<b>0,41</b>
--	--------	------	-----	-----------	-------------

Hinweis: Verkauf pro Verpackungseinheit.

## Uponor Multi Randdämmstreifen Klebefolie

 <b>1000080</b>	150x10mm	-	200	m MZ	<b>3,15</b>
--	----------	---	-----	---------	-------------

Hinweis: Verkauf pro Verpackungseinheit.

## Uponor Multi Randdämmstreifen mit Folie

 <b>1000079</b>	150x8mm	-	200	m MZ	<b>1,54</b>
--	---------	---	-----	---------	-------------

Hinweis: Verkauf pro Verpackungseinheit.

## Uponor Multi PE Randdämmstreifen mit Klebefolie HB

 <b>1135494</b>	150x8mm	-	250	m MZ	<b>1,54</b>
--	---------	---	-----	---------	-------------

Hinweis: Verkauf pro Verpackungseinheit.

## Uponor Multi Dehnungsfugenprofil

 <b>1090229</b>	1800x100x10mm	720	18	m MZ	<b>14,47</b>
--	---------------	-----	----	---------	--------------

## Uponor Multi Klebeband

 <b>1000012</b>	66m 50mm	36	1	St. MZ	<b>8,44</b>
--	----------	----	---	-----------	-------------

Art-Nr.	Dimension	LE	VE	ME RG	Preis/ME
 <b>1000082</b>	20mm 300x5mm	1800	30	St. MZ	<b>1,40</b>

## Uponor Multi Messstellenmarkierung

 <b>1000083</b>	100mm	-	10	St. MZ	<b>8,06</b>
--	-------	---	----	-----------	-------------

## Uponor Multi Gebundene Schüttung

 <b>1000052</b>	100l	2500	100	l C1	<b>1,62</b>
--	------	------	-----	---------	-------------

Hinweis: Verkauf pro Verpackungseinheit von 1 Sack = 100 l

# Verteil und Steigleitungen > 20 mm

Art-Nr.	Dimension	LE	VE	ME RG	Preis/ME
---------	-----------	----	----	----------	----------

## Uponor Uni Pipe PLUS weiß S

 <b>1060785</b>	25x2,5 3m	30	3	m E1	<b>15,71</b>
<b>1060786</b>	32x3,0 3m	21	3	m E1	<b>22,49</b>

## Uponor MLC Rohr weiß S

 <b>1013448</b>	40x4,0 3m	12	3	m E1	<b>41,87</b>
<b>1021980</b>	50x4,5 3m	12	3	m E1	<b>59,38</b>
<b>1021981</b>	63x6,0 3m	9	3	m E1	<b>75,30</b>
<b>1013453</b>	75x7,5 5m	255	5	m E1	<b>118,96</b>

## Uponor S-Press PLUS Kupplung PPSU

 <b>1039935</b>	25-25	80	10	St. E1	<b>15,32</b>
<b>1039936</b>	32-32	80	10	St. E1	<b>22,51</b>

## Uponor S-Press Verbund Kupplung PPSU

 <b>1046401</b>	40-40	960	5	St. E1	<b>43,51</b>
<b>1046402</b>	50-50	576	3	St. E1	<b>57,65</b>
<b>1032881</b>	63-63	384	1	St. E1	<b>108,12</b>
<b>1032882</b>	75-75	384	1	St. E1	<b>174,92</b>

## Uponor S-Press PLUS Kupplung reduziert PPSU

 <b>1039940</b>	32-25	80	10	St. E1	<b>23,04</b>
--	-------	----	----	-----------	--------------

## Uponor S-Press Kupplung reduziert PPSU

 <b>1039941</b>	40-25	960	5	St. E1	<b>40,64</b>
<b>1039942</b>	40-32	960	5	St. E1	<b>40,64</b>
<b>1039943</b>	50-32	1152	3	St. E1	<b>52,96</b>

## Uponor S-Press Verbund Kupplung red. PPSU

 <b>1046406</b>	50-40	576	3	St. E1	<b>58,22</b>
<b>1032883</b>	63-40	384	1	St. E1	<b>100,40</b>
<b>1032884</b>	63-50	384	1	St. E1	<b>102,54</b>
<b>1032885</b>	75-50	384	1	St. E1	<b>147,54</b>
<b>1032886</b>	75-63	384	1	St. E1	<b>163,15</b>

## Uponor S-Press PLUS Winkel PPSU

 <b>1039931</b>	25-25	80	10	St. E1	<b>22,08</b>
<b>1039932</b>	32-32	20	5	St. E1	<b>30,39</b>

## Uponor S-Press Verbund Winkel PPSU

 <b>1046386</b>	40-40	960	5	St. E1	<b>62,22</b>
<b>1046387</b>	50-50	576	3	St. E1	<b>80,15</b>
<b>1032877</b>	63-63	210	1	St. E1	<b>148,32</b>
<b>1032878</b>	75-75	210	1	St. E1	<b>227,82</b>

Art-Nr.	Dimension	LE	VE	ME RG	Preis/ME
---------	-----------	----	----	----------	----------

## Uponor S-Press Verbund Winkel 45° PPSU

 <b>1046388</b>	40-40	960	5	St. E1	<b>62,17</b>
<b>1046389</b>	50-50	576	3	St. E1	<b>85,29</b>
<b>1032879</b>	63-63	192	1	St. E1	<b>156,47</b>
<b>1032880</b>	75-75	192	1	St. E1	<b>212,86</b>

## Uponor S-Press PLUS T-Stück PPSU

 <b>1039946</b>	25-25-25	20	5	St. E1	<b>25,09</b>
<b>1039947</b>	32-32-32	20	5	St. E1	<b>41,20</b>

## Uponor S-Press Verbund T-Stück PPSU

 <b>1046390</b>	40-40-40	720	5	St. E1	<b>89,66</b>
<b>1046391</b>	50-50-50	288	3	St. E1	<b>106,05</b>
<b>1032887</b>	63-63-63	150	1	St. E1	<b>188,65</b>
<b>1032888</b>	75-75-75	150	1	St. E1	<b>297,32</b>

## Uponor S-Press PLUS T-Stück m. Innengew.

 <b>1070598</b>	25-Rp½"FT-25	20	5	St. E1	<b>47,18</b>
<b>1070600</b>	32-Rp½"FT-32	20	5	St. E1	<b>67,60</b>

## Uponor S-Press T-Stück mit Innengewinde

 <b>1046922</b>	40-Rp½"FT-40	500	5	St. E1	<b>78,65</b>
<b>1046929</b>	50-Rp1"FT-50	240	3	St. E1	<b>130,81</b>

## Uponor S-Press PLUS Übergangsnippel

 <b>1070507</b>	25-R¾"MT	80	10	St. E1	<b>24,35</b>
<b>1070508</b>	25-R1"MT	40	5	St. E1	<b>28,77</b>
<b>1070509</b>	32-R1"MT	40	5	St. E1	<b>31,67</b>
<b>1070510</b>	32-R1 ¼"MT	20	5	St. E1	<b>41,04</b>

## Uponor S-Press Übergangsnippel

 <b>1046901</b>	40-R1 ¼"MT	960	5	St. E1	<b>51,29</b>
<b>1046902</b>	40-R1 ½"MT	960	5	St. E1	<b>56,71</b>
<b>1046905</b>	50-R1 ½"MT	1152	3	St. E1	<b>85,08</b>
<b>1046906</b>	50-R2"MT	576	3	St. E1	<b>109,33</b>
<b>1032895</b>	63-R2"MT	336	1	St. E1	<b>155,25</b>
<b>1032896</b>	75-R2 ½"MT	336	1	St. E1	<b>204,66</b>





















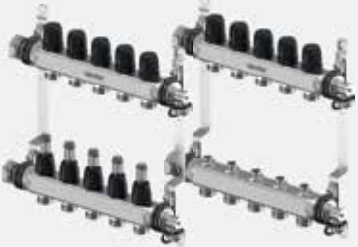





## Uponor S-Press PLUS Übergangsmuffe

 <b>1070519</b>	25-Rp¾"FT	40	5	St. E1	<b>28,31</b>
<b>1070520</b>	25-Rp1"FT	40	5	St. E1	<b>29,81</b>
<b>1070521</b>	32-Rp1"FT	40	5	St. E1	<b>34,66</b>
<b>1070522</b>	32-Rp1 ¼"FT	20	5	St. E1	<b>42,77</b>

## Uponor S-Press Übergangsmuffe

 <b>1046903</b>	40-Rp1 ¼"FT	960	5	St. E1	<b>53,36</b>
<b>1046904</b>	40-Rp1 ½"FT	960	5	St. E1	<b>53,92</b>
<b>1046907</b>	50-Rp1 ½"FT	1152	3	St. E1	<b>130,02</b>

# Uponor Stellantriebe

Passend für				Stellantrieb BISHER	NEU Stellantriebe ab 01.2024
<b>Uponor Vario PLUS</b> 	<b>Uponor Magna</b> Industrieheizungsverteiler 	Uponor Vario Regulierventil 	Uponor Vario RL-Ventil 	<b>Uponor Vario PLUS</b> Thermoantrieb PRO MT 30x1,5 	<b>Uponor Vario PLUS</b> Stellantrieb NC 
Ersatzteil für Velta Kompakt- und Velta Euroverteiler				Typ                      Art.-Nr. 24 V  1000138 230 V  1005605	Typ                      Art.-Nr. 24 V  1141679 230 V  1141678
<b>Vario S Edelstahlverteiler</b> 					<b>Uponor Vario</b> Stellantrieb NC 
<b>Uponor Vario M</b> 	<b>Uponor Comfort Port</b> vormontierte Verteilerstationen 			<b>Uponor Vario S</b> Thermoantrieb 1 W NC FT 30x1,5 	
				Typ                      Art.-Nr. 24 V  1087778 230 V  1087763	Typ                      Art.-Nr. 24 V  1141677 230 V  1141676
<b>Uponor Fluvia T</b> Pumpengruppen Push-12 (Ersatzteil) 				<b>Uponor Vario B</b> Thermoantrieb PRO FT 28x1,5 	<b>Uponor Vario</b> Stellantrieb Retrofit NC 
<b>Stellantrieb-Ersatzteile für ältere Verteiler</b> <ul style="list-style-type: none"> <li>• Polytherm ohne DF, Ersatzteil Polytherm DF</li> <li>• Unipipe</li> <li>• Vario S Edelstahl ST, LS und FM (bis 2018)</li> <li>• Chronatherm-Verteiler</li> </ul>				<b>Uponor Vario</b> Thermoantrieb Retrofit A-XXX 	
				Typ                      Art.-Nr. 24 V  1083575 230 V  1090265	Typ                      Art.-Nr. 24 V  1141681 230 V  1141680

Flächenheizung und -kühlung

# Uponor Vario PLUS

Art-Nr.	Dimension	LE	VE	ME RG	Preis/ME
---------	-----------	----	----	----------	----------

## Uponor Vario PLUS Verteiler mit Ventil

 <b>1042420</b>	LS 1x $\frac{3}{4}$ Euro	10	1	Paar MZ	<b>79,15</b>
<b>1030580</b>	LS 3x $\frac{3}{4}$ Euro	290	1	Paar MZ	<b>192,77</b>
<b>1030581</b>	LS 4x $\frac{3}{4}$ Euro	225	1	Paar MZ	<b>241,77</b>
<b>1030582</b>	LS 6x $\frac{3}{4}$ Euro	155	1	Paar MZ	<b>342,51</b>

## Uponor Vario PLUS Verteiler m. Durchfilm.

 <b>1042471</b>	FM 1x $\frac{3}{4}$ Euro	10	1	Paar MZ	<b>97,73</b>
<b>1030583</b>	FM 3x $\frac{3}{4}$ Euro	174	1	Paar MZ	<b>223,02</b>
<b>1030584</b>	FM 4x $\frac{3}{4}$ Euro	135	1	Paar MZ	<b>290,69</b>
<b>1030585</b>	FM 6x $\frac{3}{4}$ Euro	93	1	Paar MZ	<b>421,62</b>

## Uponor Vario PLUS Verteiler Basis Set

 <b>1009209</b>	K1	248	1	St. MZ	<b>152,50</b>
--	----	-----	---	-----------	---------------

## Uponor Vario PLUS Thermoantrieb NC

 <b>1000138</b>	24V MT30x1,5	10	1	St. MZ	<b>84,18</b>
<b>1005605</b>	230V MT30x1,5	10	1	St. MZ	<b>84,18</b>

Lieferung solange Vorrat reicht. Artikel läuft im Laufe des Jahres aus.

## Uponor Vario PLUS Stellantrieb NC

 <b>1141678</b>	MT 230V 1W IP54	100	1	St. MZ	<b>62,08</b>
<b>1141679</b>	MT 24V 1W IP54	100	1	St. MZ	<b>62,08</b>

## Uponor Vario Differenzdruckregler compact

 <b>1137437</b>	G1 - G1	192	1	Set MZ	<b>508,70</b>
--	---------	-----	---	-----------	---------------

## Uponor Vario PLUS Stellantrieb PRO DDC 100kOhm

 <b>1005544</b>	24V NC MT30x1,5 0-10V DC	100	1	St. MZ	<b>217,25</b>
--	--------------------------	-----	---	-----------	---------------

## Uponor Vario Klemmringverschraubung PEX

 <b>1065283</b>	14x2,0-G $\frac{3}{4}$ "FT Euro	25	1	St. MZ	<b>8,06</b>
<b>1065284</b>	16x1,8/2,0-G $\frac{3}{4}$ "FT Euro	25	1	St. MZ	<b>8,06</b>
<b>1065286</b>	17x2,0-G $\frac{3}{4}$ "FT Euro	25	1	St. MZ	<b>8,06</b>
<b>1065290</b>	20x1,9/2,0-G $\frac{3}{4}$ "FT Euro	25	1	St. MZ	<b>8,42</b>

## Uponor Vario PLUS Winkelset

 <b>1032702</b>	122/42	5	1	Paar MZ	<b>36,71</b>
--	--------	---	---	------------	--------------

## Uponor Vario PLUS Verteileranschlusset

 <b>1005227</b>		10	1	Set U1	<b>84,57</b>
--	--	----	---	-----------	--------------

## Uponor Vario PLUS Schlauchtülle

 <b>1009214</b>	G $\frac{3}{4}$ x $\frac{1}{2}$	10	1	St. MZ	<b>4,88</b>
--	---------------------------------	----	---	-----------	-------------

Art-Nr.	Dimension	LE	VE	ME RG	Preis/ME
---------	-----------	----	----	----------	----------

## Uponor Vario PLUS Distanzringset

 <b>1009215</b>		40	4	St. MZ	<b>13,38</b>
--	--	----	---	-----------	--------------

## Uponor Vario PLUS Dämmset

 <b>1063207</b>		-	1	Set MZ	<b>127,65</b>
--	--	---	---	-----------	---------------

## Uponor Vario Regulierventil G1-RP1

 <b>1137413</b>		10	1	Set MZ	<b>142,66</b>
--	--	----	---	-----------	---------------

## Uponor Vario PLUS Thermometer 0-60°C

 <b>1034524</b>	D=40mm	20	1	Paar U1	<b>28,15</b>
--	--------	----	---	------------	--------------

## Uponor Vario PLUS Durchflussmesser

 <b>1009217</b>	4 l/min	20	1	St. MZ	<b>21,07</b>
--	---------	----	---	-----------	--------------

## Uponor Vario PLUS Vorlauf-Ventileinsatz scale 1-5

 <b>1034523</b>		-	20	St. U1	<b>20,92</b>
---	--	---	----	-----------	--------------

## Uponor Vario PLUS Rücklaufventileinsatz

 <b>1005250</b>		10	1	St. U1	<b>18,48</b>
--	--	----	---	-----------	--------------

## Uponor Vario Rücklauf-Ventileinsatz

 <b>1005099</b>		10	1	St. U1	<b>40,60</b>
--	--	----	---	-----------	--------------

## Uponor Vario Vorlaufventil-Handrad, weiß white

 <b>1005101</b>		-	1	St. U1	<b>3,32</b>
--	--	---	---	-----------	-------------

## Uponor Vario Handrad COMP

 <b>1005104</b>		100	10	St. U1	<b>4,59</b>
--	--	-----	----	-----------	-------------

## Uponor Vario Vorlaufventileinsatz

 <b>1005098</b>		-	1	St. U1	<b>39,96</b>
--	--	---	---	-----------	--------------

## Uponor Vario Ersatzadapter Set

 <b>1141758</b>	M, MAGNA, PLUS, S	50	1	Set MZ	<b>14,83</b>
--	-------------------	----	---	-----------	--------------

# Uponor Vario S

Art-Nr.	Dimension	LE	VE	ME RG	Preis/ME
---------	-----------	----	----	----------	----------

## Uponor Vario S Verteiler FM

 <b>OUT</b>	<b>1086538</b>	2X¾ Euro	108	1	St. MZ	<b>177,02</b>
<b>OUT</b>	<b>1086539</b>	3x¾ Euro	108	1	St. MZ	<b>228,79</b>
<b>OUT</b>	<b>1086540</b>	4x¾ Euro	108	1	St. MZ	<b>282,04</b>
<b>OUT</b>	<b>1086541</b>	5x¾ Euro	108	1	St. MZ	<b>332,40</b>
<b>OUT</b>	<b>1086542</b>	6x¾ Euro	72	1	St. MZ	<b>384,22</b>
<b>OUT</b>	<b>1086543</b>	7x¾ Euro	72	1	St. MZ	<b>434,57</b>
<b>OUT</b>	<b>1086544</b>	8x¾ Euro	72	1	St. MZ	<b>487,83</b>
<b>OUT</b>	<b>1086545</b>	9x¾ Euro	72	1	St. MZ	<b>541,09</b>
<b>OUT</b>	<b>1086546</b>	10x¾ Euro	48	1	St. MZ	<b>594,32</b>
<b>OUT</b>	<b>1086547</b>	11x¾ Euro	48	1	St. MZ	<b>647,57</b>
<b>OUT</b>	<b>1086548</b>	12x¾ Euro	48	1	St. MZ	<b>700,83</b>
<b>OUT</b>	<b>1088864</b>	13x¾ Euro	48	1	St. MZ	<b>769,88</b>
<b>OUT</b>	<b>1088865</b>	14x¾ Euro	36	1	St. MZ	<b>827,27</b>
<b>OUT</b>	<b>1088866</b>	15x¾ Euro	36	1	St. MZ	<b>884,97</b>
<b>OUT</b>	<b>1088867</b>	16x¾ Euro	36	1	St. MZ	<b>935,14</b>

Lieferung solange Vorrat reicht. Artikel läuft im Laufe des Jahres aus.

Art-Nr.	Dimension	LE	VE	ME RG	Preis/ME
---------	-----------	----	----	----------	----------

## Uponor Vario S Verteiler LS

 <b>OUT</b>	<b>1088045</b>	2x¾ Euro	108	1	St. MZ	<b>165,46</b>
<b>OUT</b>	<b>1088046</b>	3x¾ Euro	108	1	St. MZ	<b>205,78</b>
<b>OUT</b>	<b>1088047</b>	4x¾ Euro	108	1	St. MZ	<b>236,02</b>
<b>OUT</b>	<b>1088048</b>	5x¾ Euro	108	1	St. MZ	<b>267,62</b>
<b>OUT</b>	<b>1088049</b>	6x¾ Euro	72	1	St. MZ	<b>305,08</b>
<b>OUT</b>	<b>1088050</b>	7x¾ Euro	72	1	St. MZ	<b>338,18</b>
<b>OUT</b>	<b>1088051</b>	8x¾ Euro	72	1	St. MZ	<b>374,11</b>
<b>OUT</b>	<b>1088052</b>	9x¾ Euro	72	1	St. MZ	<b>408,67</b>
<b>OUT</b>	<b>1088053</b>	10x¾ Euro	48	1	St. MZ	<b>450,39</b>
<b>OUT</b>	<b>1088054</b>	11x¾ Euro	48	1	St. MZ	<b>484,94</b>
<b>OUT</b>	<b>1088055</b>	12X¾ Euro	48	1	St. MZ	<b>518,06</b>
<b>OUT</b>	<b>1088868</b>	13x¾ Euro	48	1	St. MZ	<b>677,82</b>
<b>OUT</b>	<b>1088869</b>	14x¾ Euro	36	1	St. MZ	<b>726,59</b>
<b>OUT</b>	<b>1088870</b>	15x¾ Euro	36	1	St. MZ	<b>784,29</b>
<b>OUT</b>	<b>1088871</b>	16x¾ Euro	36	1	St. MZ	<b>913,68</b>

Lieferung solange Vorrat reicht. Artikel läuft im Laufe des Jahres aus.

Flächenheizung  
und -kühlung

## Uponor Vario S Verteiler FM

 <b>NEU</b>	<b>1140833</b>	2xG¾ Euro - G1	108	1	St. MZ	<b>177,02</b>
<b>NEU</b>	<b>1140834</b>	3xG¾ Euro - G1	108	1	St. MZ	<b>228,79</b>
<b>NEU</b>	<b>1140835</b>	4xG¾ Euro - G1	90	1	St. MZ	<b>282,04</b>
<b>NEU</b>	<b>1140836</b>	5xG¾ Euro - G1	90	1	St. MZ	<b>332,40</b>
<b>NEU</b>	<b>1140837</b>	6xG¾ Euro - G1	90	1	St. MZ	<b>384,22</b>
<b>NEU</b>	<b>1140838</b>	7xG¾ Euro - G1	54	1	St. MZ	<b>434,57</b>
<b>NEU</b>	<b>1140839</b>	8xG¾ Euro - G1	54	1	St. MZ	<b>487,83</b>
<b>NEU</b>	<b>1140840</b>	9xG¾ Euro - G1	54	1	St. MZ	<b>541,09</b>
<b>NEU</b>	<b>1140841</b>	10xG¾ Euro - G1	54	1	St. MZ	<b>594,32</b>
<b>NEU</b>	<b>1140842</b>	11xG¾ Euro - G1	54	1	St. MZ	<b>647,57</b>
<b>NEU</b>	<b>1140843</b>	12xG¾ Euro - G1	54	1	St. MZ	<b>700,83</b>
<b>NEU</b>	<b>1140844</b>	13xG¾ Euro - G1	36	1	St. MZ	<b>769,88</b>
<b>NEU</b>	<b>1140845</b>	14xG¾ Euro - G1	36	1	St. MZ	<b>827,27</b>
<b>NEU</b>	<b>1140846</b>	15xG¾ Euro - G1	36	1	St. MZ	<b>884,97</b>
<b>NEU</b>	<b>1140847</b>	16xG¾ Euro - G1	36	1	St. MZ	<b>935,14</b>

## Uponor Vario S Verteiler LS

 <b>NEU</b>	<b>1140863</b>	2xG¾ Euro - G1	108	1	St. MZ	<b>165,46</b>
<b>NEU</b>	<b>1140864</b>	3xG¾ Euro - G1	108	1	St. MZ	<b>205,78</b>
<b>NEU</b>	<b>1140865</b>	4xG¾ Euro - G1	90	1	St. MZ	<b>236,02</b>
<b>NEU</b>	<b>1140866</b>	5xG¾ Euro - G1	90	1	St. MZ	<b>267,62</b>
<b>NEU</b>	<b>1140867</b>	6xG¾ Euro - G1	54	1	St. MZ	<b>305,08</b>
<b>NEU</b>	<b>1140868</b>	7xG¾ Euro - G1	54	1	St. MZ	<b>338,18</b>
<b>NEU</b>	<b>1140869</b>	8xG¾ Euro - G1	54	1	St. MZ	<b>374,11</b>
<b>NEU</b>	<b>1140870</b>	9xG¾ Euro - G1	54	1	St. MZ	<b>408,67</b>
<b>NEU</b>	<b>1140871</b>	10xG¾ Euro - G1	54	1	St. MZ	<b>450,39</b>
<b>NEU</b>	<b>1140872</b>	11xG¾ Euro - G1	54	1	St. MZ	<b>484,94</b>
<b>NEU</b>	<b>1140873</b>	12xG¾ Euro - G1	54	1	St. MZ	<b>518,06</b>
<b>NEU</b>	<b>1140874</b>	13xG¾ Euro - G1	36	1	St. MZ	<b>677,82</b>
<b>NEU</b>	<b>1140875</b>	14xG¾ Euro - G1	36	1	St. MZ	<b>726,59</b>
<b>NEU</b>	<b>1140876</b>	15xG¾ Euro - G1	36	1	St. MZ	<b>784,29</b>
<b>NEU</b>	<b>1140877</b>	16xG¾ Euro - G1	36	1	St. MZ	<b>913,68</b>

## Uponor Vario Stellantrieb NC

 <b>NEU</b>	<b>1141676</b>	FT 230V 1W IP54	100	1	St. MZ	<b>39,34</b>
<b>NEU</b>	<b>1141677</b>	FT 24V 1W IP54	100	1	St. MZ	<b>39,34</b>

## Uponor Vario Ersatzadapter Set

 <b>NEU</b>	<b>1141758</b>	M, MAGNA, PLUS, S	50	1	Set MZ	<b>14,83</b>
--	----------------	-------------------	----	---	--------	--------------

## Uponor Vario S Thermoantrieb Edelstahl. NC

 <b>OUT</b>	<b>1013008</b>	24V FT30x1,5	10	1	St. MZ	<b>44,84</b>
<b>OUT</b>	<b>1013006</b>	230V FT30x1,5	10	1	St. MZ	<b>44,84</b>

Lieferung solange Vorrat reicht. Artikel läuft im Laufe des Jahres aus.

# Uponor Vario S

Art-Nr.	Dimension	LE	VE	ME RG	Preis/ME
---------	-----------	----	----	----------	----------

## Uponor Vario Differenzdruckregler compact

 <b>1137437</b>	G1 - G1	192	1	Set MZ	<b>508,70</b>
--	---------	-----	---	-----------	---------------

## Uponor Vario Regulierventil G1-RP1

 <b>NEU</b> <b>1137413</b>		10	1	Set MZ	<b>142,66</b>
---	--	----	---	-----------	---------------

## Uponor Vario Kugelhahn

 <b>1059132</b>	NP G1-G1	10	1	Set D1	<b>61,88</b>
--	----------	----	---	-----------	--------------

## Uponor Vario Kugelhahn

 <b>1086558</b>	¾-G1	10	1	Set MZ	<b>44,69</b>
--	------	----	---	-----------	--------------

## Uponor Vario Eck-Kugelhahn

 <b>1086559</b>	Rp ¾" - G1"	-	1	Set MZ	<b>82,02</b>
--	-------------	---	---	-----------	--------------

## Uponor Vario Eckkugelhahn

 <b>1090732</b>	G1-Rp1	260	1	Set D1	<b>76,46</b>
--	--------	-----	---	-----------	--------------

## Uponor Vario Anschlussstück

 <b>1058573</b>	G1-G1A	30	1	St. MZ	<b>28,07</b>
--	--------	----	---	-----------	--------------

## Uponor Vario VL-Feinregulierventil

 <b>1005107</b>	½" - G¾	50	1	St. MZ	<b>40,92</b>
--	---------	----	---	-----------	--------------

## Uponor Vario RL-Ventil

 <b>1005108</b>	½" - G¾	50	1	St. MZ	<b>34,89</b>
--	---------	----	---	-----------	--------------

Art-Nr.	Dimension	LE	VE	ME RG	Preis/ME
---------	-----------	----	----	----------	----------

## Uponor Vario WMZ - Anschluss horizontal

 <b>1090730</b>	G¾" 110mm	250	1	Set D1	<b>159,76</b>
<b>1090728</b>	G1" 130mm	-	1	Set D1	<b>249,84</b>

## Uponor Vario WMZ - Anschlussset vertikal

 <b>1090731</b>	G¾" 110mm	250	1	Set D1	<b>233,87</b>
<b>1090729</b>	G1" 130mm	250	1	Set D1	<b>259,93</b>

## Uponor Aqua PLUS Vert.-kappe m. Dicht.

 <b>1001337</b>	¾"FT	250	10	St. F1	<b>6,94</b>
--	------	-----	----	-----------	-------------

## Uponor Vario S Thermometer

 <b>1086537</b>		10	1	Set U1	<b>37,78</b>
--	--	----	---	-----------	--------------

## Uponor Vario S Verteiler Kappenventil LS

 <b>1088056</b>		-	10	St. U1	<b>9,69</b>
--	--	---	----	-----------	-------------

## Uponor Vario S Verteiler Durchflussm.

 <b>1087608</b>		-	10	St. U1	<b>22,81</b>
--	--	---	----	-----------	--------------



# Uponor Vario M

Art-Nr.	Dimension	LE	VE	ME RG	Preis/ME
<b>Uponor Vario M Verteiler m. Durchflusm. FM</b>					
 <b>1085944</b>	2xG $\frac{1}{4}$ Euro	80	1	St. MZ	<b>234,52</b>
<b>1085945</b>	3xG $\frac{1}{4}$ Euro	80	1	St. MZ	<b>302,21</b>
<b>1085946</b>	4xG $\frac{1}{4}$ Euro	80	1	St. MZ	<b>371,28</b>
<b>1085947</b>	5xG $\frac{1}{4}$ Euro	80	1	St. MZ	<b>440,32</b>
<b>1085948</b>	6xG $\frac{1}{4}$ Euro	80	1	St. MZ	<b>500,77</b>
<b>1085949</b>	7xG $\frac{1}{4}$ Euro	80	1	St. MZ	<b>566,98</b>
<b>1085950</b>	8xG $\frac{1}{4}$ Euro	80	1	St. MZ	<b>636,02</b>
<b>1085951</b>	9xG $\frac{1}{4}$ Euro	80	1	St. MZ	<b>702,26</b>
<b>1085952</b>	10xG $\frac{1}{4}$ Euro	80	1	St. MZ	<b>776,87</b>
<b>1086250</b>	11xG $\frac{1}{4}$ Euro	108	1	St. MZ	<b>863,20</b>
<b>1086251</b>	12xG $\frac{1}{4}$ Euro	108	1	St. MZ	<b>928,22</b>
<b>1087129</b>	13xG $\frac{1}{4}$ Euro	30	1	St. MZ	<b>1115,19</b>
<b>1087130</b>	14xG $\frac{1}{4}$ Euro	30	1	St. MZ	<b>1172,63</b>
<b>1087131</b>	15xG $\frac{1}{4}$ Euro	30	1	St. MZ	<b>1223,17</b>

## Uponor Vario Stellantrieb NC

 <b>NEU</b> <b>1141676</b>	FT 230V 1W IP54	100	1	St. MZ	<b>39,34</b>
<b>NEU</b> <b>1141677</b>	FT 24V 1W IP54	100	1	St. MZ	<b>39,34</b>

## Uponor Vario Ersatzadapter Set

 <b>NEU</b> <b>1141758</b>	M, MAGNA, PLUS, S	50	1	Set MZ	<b>14,83</b>
---	-------------------	----	---	-----------	--------------

## Uponor Vario Differenzdruckregler compact

 <b>1137437</b>	G1 - G1	192	1	Set MZ	<b>508,70</b>
--	---------	-----	---	-----------	---------------

## Uponor Vario M Automatischer Entlüfter

 <b>1089591</b>	set = 2 pce	-	1	Set MZ	<b>77,95</b>
--	-------------	---	---	-----------	--------------

Art-Nr.	Dimension	LE	VE	ME RG	Preis/ME
<b>Uponor Vario M Verteiler Durchflusm.</b>					
 <b>1121531</b>	0-5l/min	10	1	St. U1	<b>9,41</b>

## Uponor Vario M Halterung

 <b>1087531</b>		-	1	Set U1	<b>27,95</b>
--	--	---	---	-----------	--------------

## Uponor Vario M Füll-/Entleerungsventil

 <b>1120810</b>		10	1	St. U1	<b>91,63</b>
--	--	----	---	-----------	--------------

## Uponor Vario Regulierventil G1-RP1

 <b>NEU</b> <b>1137413</b>		10	1	Set MZ	<b>142,66</b>
---	--	----	---	-----------	---------------

## Uponor Vario M Rücklaufventil

 <b>1085957</b>		-	1	St. U1	<b>14,05</b>
--	--	---	---	-----------	--------------



## Uponor Vario M Thermometer

 <b>1085958</b>		-	1	Set U1	<b>19,15</b>
--	--	---	---	-----------	--------------

## Uponor Vario M Sicherheitsbügel Set

 <b>1085959</b>	3x2	-	1	Set U1	<b>9,66</b>
--	-----	---	---	-----------	-------------

# Verteilerschränke Einbaumaße

Verteilerschrank Typ		Verteilerschrankbreite								
	<b>OW Vario Verteilerschrank</b> (Aufputz-Verteilerschrank)	L (mm)	450	600	750	900	1050	1200	1350	1550
	<b>IW Vario Verteilerschrank</b> (Unterputz-Verteilerschrank)	l1 (mm)		550	700	850	1000	1150	1300	
										

Variante	Anschlusssituation	Typ	geeignet für Anzahl Heizkreise								nh min IW (mm)	IW (OW) h1 (mm)	
			-	2-4	5-7	8-10	11-13	14-15	-	-			
1	Vertikal	mit / ohne Vario WMZ-Anschlussset	OW / IW	-	2-4	5-7	8-10	11-13	14-15	-	-	95	80 (135)
2	Horizontal	mit Vario Kugelhahn	OW	2	3-5	6-8	9-11	12-14	15	-	-	80*	80 (135)
			IW		2-5								
3	Horizontal	mit Vario WMZ-Anschlussset	OW / IW	-	-	2-3	4-6	7-9	10-12	13-15	-	95	80 (135)
4	Vertikal	mit Fluvia Pumpengruppe Push 23 B	OW / IW	-	2-3	4-6	7-9	10-12	13-15	-	-	110*	110 (135)
5	Vertikal	mit Fluvia Pumpengruppe MPG / Push 23 A	OW / IW	-		2-4	5-7	8-10	11-13	14-15	-	110*	110 (135)
6	Horizontal	mit Vario Diff.-druckregler + Kugelhahn	OW / IW	-	2-4	5-7	8-10	11-13	14-15	-	-	80*	80 (135)
7	Horizontal	mit Vario Diff.-druckregler + Kugelhahn + WMZ-Anschlussset	OW	-	-	2	3-5	6-8	9-11	12-14	15	95	95 (135)
			IW								-		
8	Vertikal	mit Vario Diff.-druckregler + Kugelhahn mit / ohne WMZ-Anschlussset	OW / IW	-	2	3-5	6-8	9-11	12-14	15	-	95	95 (135)

													
1	Vertikal	mit / ohne Vario WMZ-Anschlussset	OW	2	3-5	6-8	9-10	11-13	14-16	-	-	95	80 (135)
			IW		2-5								
2	Horizontal	mit Vario Kugelhahn	OW	2-3	4-6	7-9	10-11	12-14	15-16	-	-	80*	80 (135)
			IW		2-6								
3	Horizontal	mit Vario WMZ-Anschlussset	OW	-	-	2-4	5-7	8-10	11-12	13-15	16	95	80 (135)
			IW								-		
4	Vertikal	mit Fluvia Pumpengruppe Push 23 B	OW / IW	-	2-4	5-7	8-10	11-12	13-15	16	-	110*	110 (135)
5	Vertikal	mit Fluvia Pumpengruppe MPG / Push 23 A	OW / IW	-	2	3-5	6-8	9-10	11-13	14-16	-	110*	110 (135)
6	Horizontal	mit Vario Diff.-druckregler + Kugelhahn	OW / IW	-	2-4	5-7	8-10	11-12	13-15	16	-	80*	80 (135)
7	Horizontal	mit Vario Diff.-druckregler + Kugelhahn + WMZ-Anschlussset	OW	-	-	2	3-5	6-8	9-11	12-15	16	95	80 (135)
			IW								-		
8	Vertikal	mit Vario Diff.-druckregler + Kugelhahn mit / ohne WMZ-Anschlussset	OW / IW	-	2-3	4-6	7-9	10-11	12-14	15-16	-	95	80 (135)

\*plus 10 mm bei Einsatz der Kunststoffür

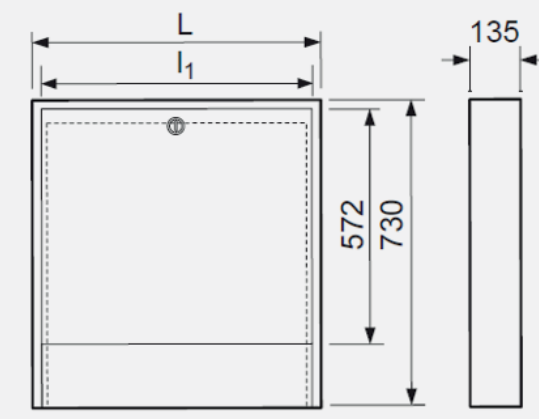
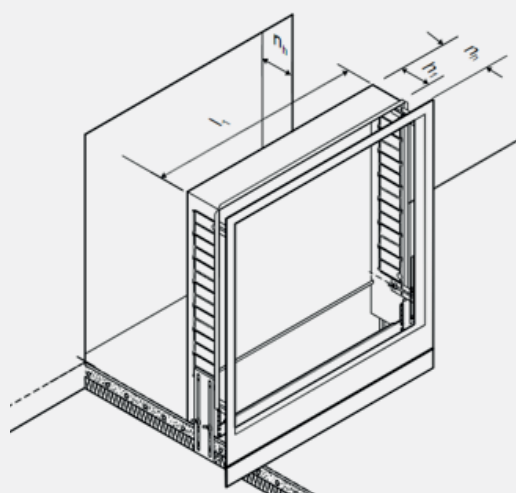

# Uponor Vario

Art-Nr.	Dimension	LE	VE	ME RG	Preis/ME
 <b>1093491</b>	550x730x110mm	18	1	St. MZ	<b>126,34</b>
<b>1093492</b>	700x730x110mm	16	1	St. MZ	<b>143,27</b>
<b>1093493</b>	850x730x110mm	13	1	St. MZ	<b>156,01</b>
<b>1093494</b>	1000x730x110mm	12	1	St. MZ	<b>180,74</b>
<b>1093495</b>	1150x730x110mm	8	1	St. MZ	<b>204,16</b>
<b>1093496</b>	1300x730x110mm	8	1	St. MZ	<b>216,17</b>

## Uponor Vario Verteilerschrank IW

 <b>1093497</b>	550x730x80mm	28	1	St. MZ	<b>118,89</b>
<b>1093498</b>	700x730x80mm	25	1	St. MZ	<b>137,51</b>
<b>1093499</b>	850x730x80mm	19	1	St. MZ	<b>154,32</b>
<b>1093500</b>	1000x730x80mm	18	1	St. MZ	<b>175,58</b>
<b>1093501</b>	1150x730x80mm	12	1	St. MZ	<b>205,37</b>
<b>1093502</b>	1300x730x80mm	12	1	St. MZ	<b>216,17</b>

## Uponor Vario Schrank Rahmen/Tür IW S

 <b>1093528</b>	550x730mm	5	1	St. MZ	<b>130,44</b>
<b>1093541</b>	700x730mm	5	1	St. MZ	<b>156,86</b>
<b>1093542</b>	850x730mm	5	1	St. MZ	<b>176,97</b>
<b>1093543</b>	1000x730mm	5	1	St. MZ	<b>208,63</b>
<b>1093544</b>	1150x730mm	5	1	St. MZ	<b>240,28</b>
<b>1093546</b>	1300x730mm	5	1	St. MZ	<b>277,70</b>

Ab Schrankbreite 1150 x 730 werden 2 Schlösser benötigt!

## Uponor Vario Zylinderschloss 2 Schlüssel

 <b>1093554</b>		200	1	St. U1	<b>30,00</b>
--	--	-----	---	-----------	--------------

## Uponor Vario Schiene

 <b>1093555</b>		200	1	St. U1	<b>14,26</b>
--	--	-----	---	-----------	--------------

Art-Nr.	Dimension	LE	VE	ME RG	Preis/ME
 <b>1136215</b>	450x730x135	25	1	St. MZ	<b>210,11</b>
<b>1136216</b>	600x730x135	17	1	St. MZ	<b>248,93</b>
<b>1136217</b>	750x730x135	15	1	St. MZ	<b>270,94</b>
<b>1136218</b>	900x730x135	12	1	St. MZ	<b>309,64</b>
<b>1136219</b>	1050x730x135	11	1	St. MZ	<b>342,82</b>
<b>1136220</b>	1200x730x135	7	1	St. MZ	<b>375,99</b>
<b>1136221</b>	1350x730x135	7	1	St. MZ	<b>404,34</b>
<b>1136222</b>	1550x730x135	7	1	St. MZ	<b>453,40</b>

Ab Schrankbreite 1200 x 730 werden 2 Schlösser benötigt!











## Uponor Vario Schrankrückwand OW







 <b>1136223</b>	450x730	5	1	St. MZ	<b>173,62</b>
<b>1136224</b>	600x730	5	1	St. MZ	<b>197,95</b>
<b>1136225</b>	750x730	5	1	St. MZ	<b>232,23</b>
<b>1136226</b>	900x730	5	1	St. MZ	<b>263,20</b>
<b>1136227</b>	1050x730	5	1	St. MZ	<b>291,94</b>
<b>1136228</b>	1200x730	5	1	St. MZ	<b>317,39</b>
<b>1136229</b>	1350x730	5	1	St. MZ	<b>337,29</b>
<b>1136230</b>	1550x730	5	1	St. MZ	<b>381,53</b>

## Uponor Magna Verteilerschrank Aufputz

 <b>1060553</b>	1010x835x200mm	-	1	St. MZ	<b>438,36</b>
<b>1060554</b>	1910x835x200mm	-	1	St. MZ	<b>596,16</b>
<b>1060555</b>	2310x835x200mm	-	1	St. MZ	<b>660,53</b>

# Uponor Fluvia

Art-Nr.	Dimension	LE	VE	ME RG	Preis/ME
<b>Uponor Fluvia T Pumpengruppe Push-12 TH-G</b>					
 <b>1095127</b>		60	1	St. MZ	<b>812,99</b>
<b>Uponor Fluvia T Pumpengruppe Push-12 CH-G</b>					
 <b>1095131</b>		30	1	St. MZ	<b>1913,91</b>
<b>Uponor Fluvia T Regeleinheit Push-12-CH-X</b>					
 <b>1085982</b>		50	1	St. MZ	<b>1079,09</b>
<b>Uponor Fluvia T Pumpengruppe Push-12 AC-G</b>					
 <b>1095128</b>		60	1	St. MZ	<b>964,13</b>
<b>Uponor Fluvia T Pumpengruppe Push-12 WL-G</b>					
 <b>1095130</b>		60	1	St. MZ	<b>1287,79</b>
<b>Uponor Fluvia Hosenstück</b>					
 <b>1005675</b>	2xG $\frac{3}{4}$ - $\frac{3}{4}$ "Euro	50	1	Set MZ	<b>62,46</b>
<b>Uponor Vario Füll / Entleerungshahn</b>					
 <b>1061802</b>	$\frac{3}{4}$ " - $\frac{3}{4}$ "	10	1	Set MZ	<b>77,55</b>
<b>Uponor Aqua PLUS Vert.-kappe m. Dicht.</b>					
 <b>1001337</b>	$\frac{3}{4}$ "FT	250	10	St. F1	<b>6,94</b>
<b>Uponor Fluvia T Grundfos Pumpenkopf Push-12</b>					
 <b>1095132</b>		20	1	St. U1	<b>384,45</b>
<b>Uponor Fluvia Ventil für Push 12 Push-12</b>					
 <b>1059851</b>		-	1	St. U1	<b>180,86</b>
<b>Uponor Fluvia Thermostat f. 1059834 Push-12 TH</b>					
 <b>1059852</b>		-	1	St. U1	<b>152,05</b>

Art-Nr.	Dimension	LE	VE	ME RG	Preis/ME
<b>Uponor Fluvia Move Pumpengruppe Push-23-A-AC</b>					
 <b>1085008</b>		30	1	St. MZ	<b>1971,48</b>
<b>Uponor Fluvia T Pumpengruppe Push-23-B-W</b>					
 <b>1078304</b>		55	1	St. MZ	<b>1273,35</b>
<b>Uponor Fluvia T Thermostat m. Fernfühler Push-23, KRS-6</b>					
 <b>1063461</b>		-	1	St. U1	<b>147,02</b>
<b>Uponor Fluvia Rücklauf-Regulierventil Push-23, MPG, KRS-6</b>					
 <b>1059282</b>		10	1	St. U1	<b>56,76</b>
<b>Uponor Fluvia Vorlauf-Thermostatventil Push-23, KRS-6</b>					
 <b>1059283</b>		10	1	St. U1	<b>56,76</b>
<b>Uponor Fluvia Mischventil für PUSH-23 Push-23, KRS-6</b>					
 <b>1061525</b>	$\frac{3}{4}$ xG1xG1	-	1	St. U1	<b>145,02</b>

# Uponor Fluvia

Art-Nr.	Dimension	LE	VE	ME RG	Preis/ME
---------	-----------	----	----	----------	----------

## Uponor Fluvia Move Pumpengruppe MPG-10-A-W

 1078306		30	1	St. MZ	3914,36
---	--	----	---	-----------	---------

## Uponor Fluvia Pumpengruppe MPG-10-B-W

 1078307		30	1	St. MZ	1640,52
---	--	----	---	-----------	---------

## Uponor Fluvia Pumpe Wilo Para SC

 1095309	6m, 180mm	-	1	St. U1	805,06
---	-----------	---	---	-----------	--------

## Uponor Vario Anschlussstück

 1058573	G1-G1A	30	1	St. MZ	28,07
---	--------	----	---	-----------	-------

## Uponor Fluvia Mischventil für 1048780 MPG

 1071964		-	1	St. U1	291,54
--	--	---	---	-----------	--------

## Uponor Fluvia Move Pumpengruppe CPG-15-C-W

 1119445		18	1	St. MZ	2690,58
---	--	----	---	-----------	---------

## Uponor Fluvia Pumpengruppe CPG-15-D-W

 1119448		18	1	St. MZ	1365,99
---	--	----	---	-----------	---------

Art-Nr.	Dimension	LE	VE	ME RG	Preis/ME
---------	-----------	----	----	----------	----------

## Uponor Fluvia Dreiwegemischer CPG, EPG

 1119813		10	1	St. U1	241,52
---	--	----	---	-----------	--------

## Uponor Fluvia Move PLUS Mischermotor 230V

 1119812		10	1	St. U1	402,52
---	--	----	---	-----------	--------

## Uponor Fluvia Max.-Begrenzungstherm.

 1005504	5-60deg	10	1	St. MZ	83,75
---	---------	----	---	-----------	-------

## Uponor Fluvia Move Pumpengruppe PPG-30-A-W

 1084143		22	1	St. MZ	4475,54
---	--	----	---	-----------	---------

## Uponor Fluvia Move Pumpengruppe EPG-6-A-W

 1078310		8	1	St. MZ	5310,07
--	--	---	---	-----------	---------

## Uponor Smatrix Move Mischermotor 24V (0-10V) pro

 1002356	A-15x 24V 0-10V	-	1	St. MZ	787,48
---	-----------------	---	---	-----------	--------

## Uponor Smatrix Move Mischermotor 230V

 1002357		-	1	St. MZ	309,13
---	--	---	---	-----------	--------





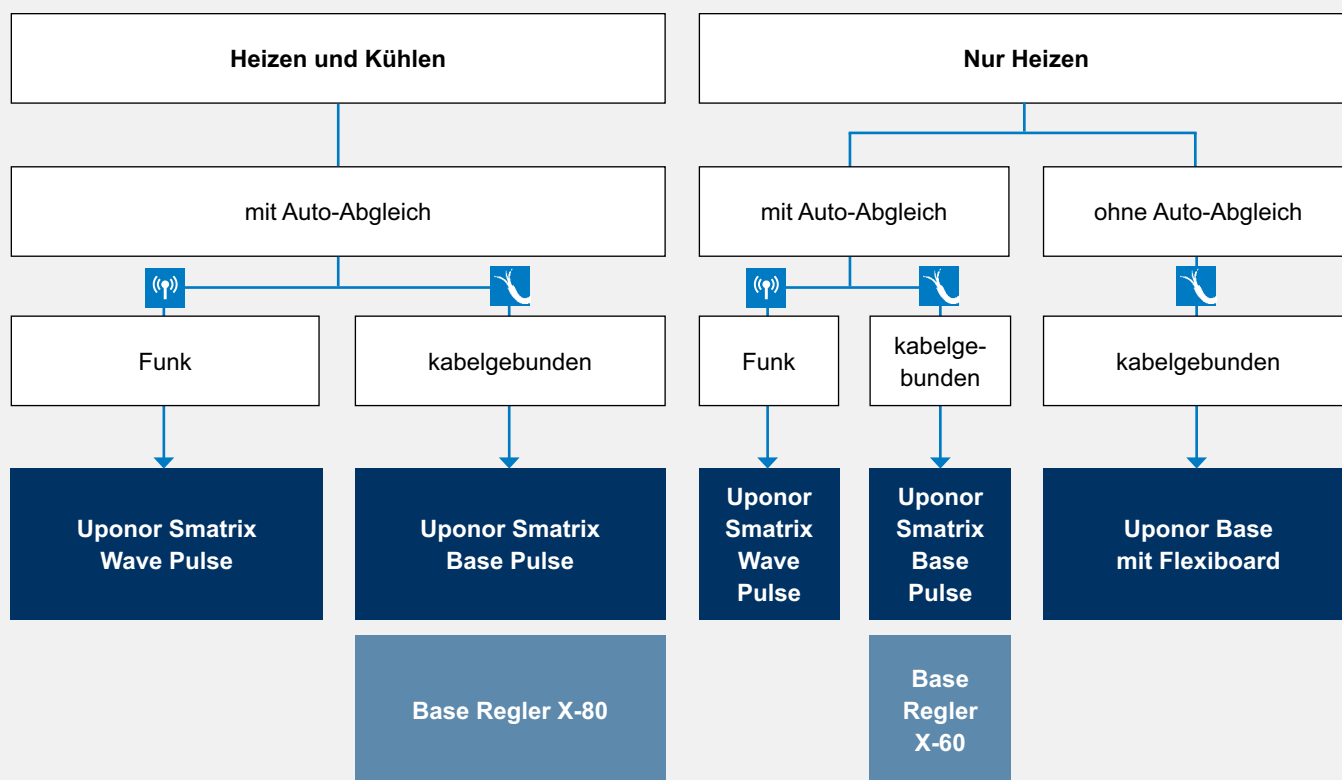

## Uponor Fluvia IMP NMT mini

 1134170	15/70-130	-	1	St. U1	657,99
---	-----------	---	---	-----------	--------

# Systemfinder Regelungstechnik





## Einzelraumregelungen Wohnungsbau

Uponor Smatrix	Beschreibung
 <b>Uponor Smatrix Wave Pulse</b>	Per App gesteuerte <i>Funk-Einzelraumregelung</i> zum Heizen und Kühlen mit vielen Features, z.B. Anbindung an Smart Home ( <i>Amazon Alexa, Google Home</i> ) mit R-208 und Cloud
 <b>Uponor Smatrix Wave</b>	Funk-Raumtemperaturregelung für die Flächenheizung und -kühlung
 <b>Uponor Smatrix Base Pulse</b>	Per App gesteuerte <i>kabelgebundene Einzelraumregelung</i> zum Heizen und Kühlen mit vielen Features, z.B. Anbindung an Smart Home ( <i>Amazon Alexa, Google Home</i> ) mit R-208 und Cloud
 <b>Uponor Smatrix Base PRO</b>	Kabelgebundene Einzelraumregelung zum Heizen und Kühlen mit bis zu 16 Regelmodulen für den Gewerbebau und für große Objekte
  <b>Uponor Smatrix Style</b>	Designraumfühler mit Feuchteüberwachung (für Smatrix Wave/Base Pulse und Smatrix Base PRO)
Uponor	Beschreibung
<b>Uponor Base</b>	Konventionelle verdrahtete 230 V-Einzelraumregelung zum Heizen und Kühlen
<b>Uponor Space</b>	Einfach zu bedienende Taupunktüberwachung für Kühldecken
<b>Smatrix Move</b>	Witterungsgeführter Vorlauftemperaturregler zum Heizen und Kühlen

# Uponor Smatrix Funktionen

## Funktionsumfang Smatrix Wave Pulse (Funk) und Smatrix Base Pulse (kabelgebunden)

Uponor Smatrix Regelungstechnik	Komplettversion		ohne Cloud		nur Regelmodul	
	 Smatrix Wave Pulse	 Smatrix Base Pulse	 Smatrix Wave Pulse	 Smatrix Base Pulse	 Smatrix Wave Pulse	 Smatrix Base Pulse
Fernzugriff	■	■				
Komforteinstellung	■	■				
Absenprogramme	■	■				
Updates per App	■	■				
Einbindung (Amazon Alexa, Google Home) mit R-208	■	■				
Fernschaltung weiterer Anlagenkomponenten per Relaismodul	■					
Lokaler Zugriff über WLAN	■	■	■	■		
Max./Min.-Begrenzung der Sollwerttemperatur	■	■	■	■		
Einrichten einer Regelungsgruppe aus 4 Regelmodulen	■	■	■	■		
Erweiterte Heizen/ Kühlen-Umschaltmöglichkeiten	■	■	■	■		
Zentraler Absenkmodus	■	■	■	■		
Auto-Abgleich	■	■	■	■	■	■
Heizen und Kühlen	■	■	■	■	■	■
RF Schalterleiste		■		■		■
Regelung von Heizkörpern	■		■		■	

Flächenheizung und -kühlung

# Uponor Smatrix Wave



Art-Nr.	Dimension	LE	VE	ME RG	Preis/ME
---------	-----------	----	----	----------	----------

## Uponor Smatrix Wave Starter-Set Pulse S

 <b>1093284</b>		3	1	Set MZ	<b>1798,64</b>
--	--	---	---	-----------	----------------

## Uponor Smatrix Wave Starter-Set Pulse L

 <b>1093287</b>		2	1	Set MZ	<b>2776,91</b>
--	--	---	---	-----------	----------------

## Uponor Smatrix Schnittstelle Pulse com R-208

 <b>1093030</b>		16	1	St. MZ	<b>702,28</b>
--	--	----	---	-----------	---------------

## Uponor Smatrix Wave Regelmodul Pulse X-265 6X

 <b>1093021</b>		4	1	St. MZ	<b>554,00</b>
--	--	---	---	-----------	---------------

## Uponor Smatrix Wave Slave-Modul Pulse M-262 6X

 <b>1093133</b>		16	1	St. MZ	<b>142,03</b>
--	--	----	---	-----------	---------------

## Uponor Smatrix Wave Antenne Pulse A-265

 <b>1093028</b>		16	1	St. U1	<b>317,53</b>
--	--	----	---	-----------	---------------

## Uponor Smatrix Wave Funk Schaltmodul M-161

 <b>1071673</b> 2x		16	1	St. MZ	<b>168,36</b>
---	--	----	---	-----------	---------------

## Uponor Smatrix Wave RT-Feuchtfühler Style T-169 D+ RH

 <b>1087816</b> weiß		180	1	St. MZ	<b>247,49</b>
---	--	-----	---	-----------	---------------

 <b>1087817</b> schwarz		180	1	St. MZ	<b>247,49</b>
--	--	-----	---	-----------	---------------

## Uponor Smatrix Wave RT-Feuchtfühler Style T-161

 <b>1087815</b>		180	1	St. MZ	<b>230,26</b>
--	--	-----	---	-----------	---------------

Art-Nr.	Dimension	LE	VE	ME RG	Preis/ME
---------	-----------	----	----	----------	----------

## Uponor Smatrix Wave Raumfühler prog.+RH T-168 P+RH

 <b>1086984</b> RAL9016		75	1	St. MZ	<b>221,58</b>
--	--	----	---	-----------	---------------

## Uponor Smatrix Wave Raumfühler digit. T-166 D

 <b>1086982</b> RAL9016		75	1	St. MZ	<b>195,68</b>
--	--	----	---	-----------	---------------

## Uponor Smatrix Wave Raumfühler T-165 POD standard

 <b>1086981</b> RAL9016		75	1	St. MZ	<b>161,16</b>
--	--	----	---	-----------	---------------

## Uponor Smatrix Wave Raumfühler BM T-163 public

 <b>1086979</b> RAL9016		75	1	St. MZ	<b>212,95</b>
--	--	----	---	-----------	---------------

## Uponor Smatrix Wave Thermostatkopf T-162

 <b>1071660</b>		16	1	St. MZ	<b>154,20</b>
--	--	----	---	-----------	---------------

## Uponor Smatrix Wandrahmen T-X A-1XX

 <b>1086986</b> RAL9016		250	1	St. MZ	<b>9,36</b>
--	--	-----	---	-----------	-------------

## Uponor Smatrix Boden- oder Fernfühler S-1XX

 <b>1071684</b>		63	1	St. MZ	<b>49,21</b>
--	--	----	---	-----------	--------------

## Uponor Smatrix Schaltmodul H/K M-1XX

 <b>1083576</b> 24V		84	1	St. MZ	<b>187,07</b>
--	--	----	---	-----------	---------------

## Uponor Smatrix Schaltmodul H/K M-1XX

 <b>1083577</b> 230V		16	1	St. MZ	<b>202,88</b>
---	--	----	---	-----------	---------------

## Uponor Vario Stellantrieb NC

 <b>NEU</b> <b>1141677</b> FT 24V 1W IP54		100	1	St. MZ	<b>39,34</b>
--	--	-----	---	-----------	--------------

## Uponor Vario Thermoantrieb Retrofit A-XXX

 <b>OUT</b> <b>1083575</b> 24V, NC, 1W		100	1	Set MZ	<b>71,24</b>
---	--	-----	---	-----------	--------------

Lieferung solange Vorrat reicht. Artikel läuft im Laufe des Jahres aus.

## Uponor Vario Stellantrieb Retrofit NC

 <b>NEU</b> <b>1141681</b> FT 24V 1W IP54		100	1	St. MZ	<b>69,20</b>
--	--	-----	---	-----------	--------------

## Uponor Vario PLUS Stellantrieb NC

 <b>NEU</b> <b>1141679</b> MT 24V 1W IP54		100	1	St. MZ	<b>62,08</b>
--	--	-----	---	-----------	--------------





# Uponor Smatrix Base

Art-Nr.	Dimension	LE	VE	ME RG	Preis/ME
---------	-----------	----	----	----------	----------

## Uponor Smatrix Base Starter-Set Pulse S

 <b>1093280</b>		3	1	Set MZ	<b>1568,65</b>
--	--	---	---	-----------	----------------

## Uponor Smatrix Base Starter-Set Pulse L

 <b>1093282</b>		2	1	Set MZ	<b>2316,90</b>
--	--	---	---	-----------	----------------

## Uponor Smatrix Schnittstelle Pulse com R-208

 <b>1093030</b>		16	1	St. MZ	<b>702,28</b>
--	--	----	---	-----------	---------------

## Uponor Smatrix Base Regelmodul Pulse X-245 BUS 6X

 <b>1093017</b>		4	1	St. MZ	<b>374,13</b>
--	--	---	---	-----------	---------------

## Uponor Smatrix Base Slave-Modul Pulse M-242 BUS 6X

 <b>1093134</b>		16	1	St. MZ	<b>127,07</b>
--	--	----	---	-----------	---------------

## Uponor Smatrix Base Stern-Modul Pulse M-243 BUS 6X

 <b>1093135</b>		16	1	St. MZ	<b>97,14</b>
--	--	----	---	-----------	--------------

## Uponor Smatrix Base RT-Feuchtfühler Style T-149 Bus D+ RH

 <b>1087813</b> weiß		180	1	St. MZ	<b>230,26</b>
 <b>1087814</b> schwarz		180	1	St. MZ	<b>230,26</b>

## Uponor Smatrix Base PRO RT-Feuchtfühler Style T-141 Bus

 <b>1087812</b>		180	1	St. MZ	<b>130,81</b>
--	--	-----	---	-----------	---------------

## Uponor Smatrix Base Wandrahmen T-141

 <b>1122237</b> RAL9016		20	1	St. MZ	<b>6,85</b>
--	--	----	---	-----------	-------------

Art-Nr.	Dimension	LE	VE	ME RG	Preis/ME
---------	-----------	----	----	----------	----------

## Uponor Smatrix Base Raumfühler prog.+RH T-148 Bus P+RH

 <b>1086977</b> RAL9016		75	1	St. MZ	<b>145,31</b>
--	--	----	---	-----------	---------------

## Uponor Smatrix Base Raumfühler digit. T-146 Bus D

 <b>1086976</b> RAL9016		75	1	St. MZ	<b>133,97</b>
--	--	----	---	-----------	---------------

## Uponor Smatrix Base Raumthermostat T-145 Bus POD standard

 <b>1086975</b> RAL9016		75	1	St. MZ	<b>66,19</b>
--	--	----	---	-----------	--------------

## Uponor Smatrix Base Raumfühler UP T-144 Bus

 <b>1086973</b> RAL9016		60	1	St. MZ	<b>105,18</b>
--	--	----	---	-----------	---------------

## Uponor Smatrix Base Raumfühler BM T-143 Bus public

 <b>1086972</b> RAL9016		75	1	St. MZ	<b>91,52</b>
--	--	----	---	-----------	--------------

## Uponor Smatrix Boden- oder Fernfühler S-1XX

 <b>1071684</b>		63	1	St. MZ	<b>49,21</b>
--	--	----	---	-----------	--------------

## Uponor Smatrix Base Aufputz-Wandrahmen Style T-149 A-14X

 <b>1087821</b>		90	1	St. MZ	<b>9,85</b>
--	--	----	---	-----------	-------------

## Uponor Smatrix Base Aufputz-Wandrahmen Style T-149 A-14x

 <b>1087822</b>		90	1	St. MZ	<b>11,17</b>
--	--	----	---	-----------	--------------

## Uponor Smatrix Wandrahmen T-X A-1XX

 <b>1086986</b> RAL9016		250	1	St. MZ	<b>9,36</b>
--	--	-----	---	-----------	-------------

## Uponor Smatrix Base Bus-Kabel A-145

 <b>1071670</b> 50m		2	1	St. MZ	<b>191,19</b>
--	--	---	---	-----------	---------------

Flächenheizung  
und -kühlung

# Uponor Smatrix Base



Art-Nr.	Dimension	LE	VE	ME RG	Preis/ME
---------	-----------	----	----	----------	----------

## Uponor Smatrix Schaltmodul H/K M-1XX



<b>1083576</b>	24V	84	1	St. MZ	<b>187,07</b>
----------------	-----	----	---	-----------	---------------

## Uponor Smatrix Schaltmodul H/K M-1XX



<b>1083577</b>	230V	16	1	St. MZ	<b>202,88</b>
----------------	------	----	---	-----------	---------------

Art-Nr.	Dimension	LE	VE	ME RG	Preis/ME
---------	-----------	----	----	----------	----------

## Uponor Vario Stellantrieb NC



<b>NEU</b>	<b>1141677</b>	FT 24V 1W IP54	100	1	St. MZ	<b>39,34</b>
------------	----------------	----------------	-----	---	-----------	--------------

## Uponor Vario Thermoantrieb Retrofit A-XXX



<b>OUT</b>	<b>1083575</b>	24V, NC, 1W	100	1	Set MZ	<b>71,24</b>
------------	----------------	-------------	-----	---	-----------	--------------

Lieferung solange Vorrat reicht. Artikel läuft im Laufe des Jahres aus.

## Uponor Vario Stellantrieb Retrofit NC



<b>NEU</b>	<b>1141680</b>	FT 230V 1W IP54	100	1	St. MZ	<b>69,20</b>
------------	----------------	-----------------	-----	---	-----------	--------------

<b>NEU</b>	<b>1141681</b>	FT 24V 1W IP54	100	1	St. MZ	<b>69,20</b>
------------	----------------	----------------	-----	---	-----------	--------------

## Uponor Vario PLUS Stellantrieb NC



<b>NEU</b>	<b>1141678</b>	MT 230V 1W IP54	100	1	St. MZ	<b>62,08</b>
------------	----------------	-----------------	-----	---	-----------	--------------

<b>NEU</b>	<b>1141679</b>	MT 24V 1W IP54	100	1	St. MZ	<b>62,08</b>
------------	----------------	----------------	-----	---	-----------	--------------

# Uponor Smatrix Base PRO



Art-Nr.	Dimension	LE	VE	ME RG	Preis/ME
---------	-----------	----	----	----------	----------

## Uponor Smatrix Base PRO Regler X-147 Bus

 <b>1087162</b>	6x	4	1	St. MZ	<b>827,35</b>
--	----	---	---	-----------	---------------

## Uponor Smatrix Base Erweiterungsmodule M-140 Bus

 <b>1071686</b>	6x	16	1	St. MZ	<b>100,16</b>
--	----	----	---	-----------	---------------

## Uponor Smatrix Base Stern Modul M-141 Bus

 <b>1071651</b>	8X	16	1	St. MZ	<b>117,00</b>
--	----	----	---	-----------	---------------

## Uponor Smatrix Base PRO Bedienmodule I-147 Bus

 <b>1087161</b>		7	1	St. MZ	<b>798,64</b>
--	--	---	---	-----------	---------------

Art-Nr.	Dimension	LE	VE	ME RG	Preis/ME
---------	-----------	----	----	----------	----------

## Uponor Smatrix Base PRO RT-Feuchtfühler Style T-141 Bus flush

 <b>1087812</b>		180	1	St. MZ	<b>130,81</b>
--	--	-----	---	-----------	---------------

## Uponor Smatrix Base Wandrahmen T-141

 <b>1122237</b>	RAL9016	20	1	St. MZ	<b>6,85</b>
--	---------	----	---	-----------	-------------



## Uponor Smatrix Base PRO KNX Schnittst. R-147 KNX

 <b>1087164</b>		-	1	St. MZ	<b>1064,69</b>
--	--	---	---	-----------	----------------

# Uponor Base Funktionen



## Funktionsumfang Uponor Base (konventionelle 230 V-Verdrahtung)

Regelungstechnik	Uponor Base X-80	Uponor Base X-60	Uponor Base Flexiboard
<b>Funktionen:</b>			
Zentraler Absenkmodus	■	■	
Auto-Abgleich	■	■	
Heizen und Kühlen	■		
RF Schalterleiste	■	■	■
Anschluss für Kondensationsset S-80	■		
Pumpenrelais	■	■	■*
Kesselrelais	■		

\* nur X-25 und X-27

# Uponor Base



Art-Nr.	Dimension	LE	VE	ME RG	Preis/ME
---------	-----------	----	----	----------	----------

## Uponor Base Regler Heizen X-60

 <b>NEU</b> 1138349	6x 230V	6	1	St. MZ	305,00
--	---------	---	---	-----------	--------

## Uponor Base Regler Heizen / Kühlen X-80

 <b>NEU</b> 1138350	10x 230V	6	1	St. MZ	395,00
--	----------	---	---	-----------	--------

## Uponor Base Kondensationsset S-80

 <b>NEU</b> 1140221	230V	20	1	St. MZ	360,00
--	------	----	---	-----------	--------

## Uponor Base 6 Kanal Regelmodul X-23

 1058426	230V	200	1	St. MZ	187,07
---	------	-----	---	-----------	--------

## Uponor Base Flexiboard X-24

 1088331	6x 230V	-	1	St. MZ	221,60
---	---------	---	---	-----------	--------

## Uponor Base Flexiboard mit Pumpenlogik X-25

 1089086	6x 230V	-	1	St. MZ	233,08
---	---------	---	---	-----------	--------

## Uponor Base Flexiboard X-26

 1089087	8x 230V	-	1	St. MZ	246,07
---	---------	---	---	-----------	--------

## Uponor Base Flexiboard mit Pumpenlogik X-27

 1089088	8x 230V	-	1	St. MZ	270,54
---	---------	---	---	-----------	--------

Art-Nr.	Dimension	LE	VE	ME RG	Preis/ME
---------	-----------	----	----	----------	----------

## Uponor Base Raumfühler T-23 standard

 1058422	230V RAL9010	160	1	St. MZ	58,57
---	--------------	-----	---	-----------	-------

## Uponor Base Raumfühler UP T-24

 1058423	230V	-	1	St. MZ	109,80
---	------	---	---	-----------	--------

## Uponor Base Raumfühler H/K T-25 H/C

 1058424	230V	-	1	St. MZ	81,87
---	------	---	---	-----------	-------

## Uponor Base Thermostat mit Display T-27

 1120075	230V RAL9016	75	1	St. MZ	93,09
---	--------------	----	---	-----------	-------

## Uponor Base Prog. Raumfühler T-26 dig. prog. UP

 1058425	230V RAL9010	-	1	St. MZ	158,25
---	--------------	---	---	-----------	--------

## Uponor Base Fernfühler

 1047459	230V	-	1	St. MZ	27,91
---	------	---	---	-----------	-------

## Uponor Vario PLUS Stellantrieb NC

 <b>NEU</b> 1141678	MT 230V 1W IP54	100	1	St. MZ	62,08
--	-----------------	-----	---	-----------	-------

## Uponor Vario B Stellantrieb NC

 <b>OUT</b> 1022244	230V FT28x1,5	10	1	St. MZ	84,18
--	---------------	----	---	-----------	-------

Lieferung solange Vorrat reicht. Artikel läuft im Laufe des Jahres aus.

## Uponor Vario Stellantrieb NC

 <b>NEU</b> 1141676	FT 230V 1W IP54	100	1	St. MZ	39,34
--	-----------------	-----	---	-----------	-------

## Uponor Vario Stellantrieb Retrofit NC

 <b>NEU</b> 1141680	FT 230V 1W IP54	100	1	St. MZ	69,20
--	-----------------	-----	---	-----------	-------

Flächenheizung  
und -kühlung

# Uponor Space

Art-Nr.	Dimension	LE	VE	ME RG	Preis/ME
---------	-----------	----	----	----------	----------

## Uponor Space Schnittstellenkonverter TK 1PF

 <b>1000314</b>	24V	-	1	St. B6	<b>281,06</b>
--	-----	---	---	-----------	---------------

## Uponor Space Taupunktfühler TF 3 PR

 <b>1000312</b>	24V	10	1	St. B6	<b>224,53</b>
--	-----	----	---	-----------	---------------

## Uponor Space Taupunktfühler TF 3 GM

 <b>1000313</b>	24V	25	1	St. B6	<b>224,53</b>
--	-----	----	---	-----------	---------------

## Uponor Vario VL-Feinregulierventil

 <b>1005107</b>	½" - G¾	50	1	St. MZ	<b>40,92</b>
--	---------	----	---	-----------	--------------

## Uponor Vario RL-Ventil

 <b>1005108</b>	½" - G¾	50	1	St. MZ	<b>34,89</b>
---	---------	----	---	-----------	--------------

## Uponor Vario Regulierventil G1-RP1

 <b>NEU</b> <b>1137413</b>		10	1	Set MZ	<b>142,66</b>
---	--	----	---	-----------	---------------

Art-Nr.	Dimension	LE	VE	ME RG	Preis/ME
---------	-----------	----	----	----------	----------

## Uponor Vario PLUS Stellantrieb NC

 <b>NEU</b> <b>1141678</b>	MT 230V 1W IP54	100	1	St. MZ	<b>62,08</b>
<b>NEU</b> <b>1141679</b>	MT 24V 1W IP54	100	1	St. MZ	<b>62,08</b>

## Uponor Vario Stellantrieb Retrofit NC

 <b>NEU</b> <b>1141680</b>	FT 230V 1W IP54	100	1	St. MZ	<b>69,20</b>
<b>NEU</b> <b>1141681</b>	FT 24V 1W IP54	100	1	St. MZ	<b>69,20</b>

# Uponor Smatrix Move

Art-Nr.	Dimension	LE	VE	ME RG	Preis/ME
---------	-----------	----	----	----------	----------

## Uponor Smatrix Move Regler X-157 Wired

 1071693		4	1	Set MZ	1223,04
---	--	---	---	-----------	---------

## Uponor Smatrix Move Antenne A-155 Radio

 1071676		21	1	St. U1	242,74
---	--	----	---	-----------	--------

## Uponor Smatrix Move Vorl./Rücklauffühler S-152

 1071661	3m	63	1	St. MZ	117,00
---	----	----	---	-----------	--------

## Uponor Smatrix Move Außenfühler S-1XX

 1071671		45	1	St. MZ	151,10
---	--	----	---	-----------	--------

Art-Nr.	Dimension	LE	VE	ME RG	Preis/ME
---------	-----------	----	----	----------	----------

## Uponor Smatrix Schaltmodul H/K M-1XX

 1083577	230V	16	1	St. MZ	202,88
---	------	----	---	-----------	--------

## Uponor Fluvia Move PLUS Mischermotor 230V

 1119812		10	1	St. U1	402,52
---	--	----	---	-----------	--------

## Uponor Smatrix Move Mischermotor 230V

 1002357		-	1	St. MZ	309,13
---	--	---	---	-----------	--------

# Wohnungsstationen

Uponor Wohnungsstationen für die dezentrale Trinkwassererwärmung und ganzjährige Raumwärmeversorgung.

Hier gehts direkt zur Preisliste:



## Perfekte Lösungen für Effizienz, Komfort und Hygiene



Die Uponor Combi Port E-Pro Wohnungsstation passt sich mit intelligenter Regelung an alle Anforderungen automatisch an und hebt Komfort, Hygiene sowie die Energieeffizienz auf ein neues Niveau. Fragen Sie Ihren zuständigen Uponor Fachberater.





# Heizzentrale

Uponor Pumpengruppen,  
Frischwasserstationen,  
Pufferspeicher, Regelungen und  
umfangreiches Zubehör

Flächenheizung  
und -kühlung

## Alles aus einer Hand – vom Wohnungsbau bis zum Großobjekt



**Dezentrale  
Wohnungs-  
stationen**

**Zentrale  
Trinkwasser-  
erwärmung**

**Systempumpen-  
gruppen  
und Pufferspeicher**

**Pufferbeladung und  
Netzkreisregelung**







# Verbindungstechnik, Fittings und Werkzeuge für Uponor Ecoflex Rohre

Systemrohr	Abmessung [mm]	Medium- rohr	Dämmung	Mantel- rohr	Temperatur- und Druckbelastung	Länge [m]	Artikel-Nr.	Zertifizierung
<b>VIP Thermo Single</b> 	40 x 3,7/140	PE-Xa + EVOH	VIP + PEX-Schaum	PE-HD	max. 95 °C / 6 bar	200	1095714	KOMO System-zertifizierung  CSTB System-zertifizierung
	50 x 4,6/140					200	1095715	
	63 x 5,8/140					200	1095716	
	75 x 6,8/140					200	1095717	
	90 x 8,2/175					150	1095718	
	110 x 10,0/175					150	1095719	
	125 x 11,4/200					120	1095720	
<b>VIP Thermo Twin</b> 	2x25 x 2,3/140	PE-Xa + EVOH	VIP + PEX-Schaum	PE-HD	max. 95 °C / 6 bar	200	1118580	KOMO System-zertifizierung  CSTB System-zertifizierung
	2x32 x 2,9/140					200	1118581	
	2x40 x 3,7/175					200	1118582	
	2x50 x 4,6/175					200	1118583	
	2x63 x 5,8/200					100	1118584	
	2x75 x 6,8/250					100	1118585	
	<b>Thermo Single</b> 					25 x 2,3/140	PE-Xa + EVOH	
32 x 2,9/140		200	1018110					
40 x 3,7/175		200	1018111					
50 x 4,6/175		200	1018112					
63 x 5,8/175		200	1018113					
75 x 6,8/200		100	1018114					
90 x 8,2/200		100	1018115					
110 x 10,0/200		100	1018116					
<b>Thermo Twin</b> 	2x25 x 2,3/175	PE-Xa + EVOH	PEX-Schaum	PE-HD	max. 95 °C / 6 bar	200	1018134	KOMO Systemzertifizierung, Deklaration nach DIN EN 15632, DIN CERTCO Wärmeverlustzertifizierung - Überwacht nach VDI 2055, CSTB Systemzertifizierung
	2x32 x 2,9/175					200	1018135	
	2x40 x 3,7/175					200	1018136	
	2x50 x 4,6/200					100	1018137	
	2x63 x 5,8/200					100	1018138	
<b>Thermo Mini</b> 	25 x 2,3/68	PE-Xa + EVOH	PEX-Schaum	PE-HD	max. 95 °C / 6 bar	200	1018132	CSTB System-zertifizierung
	32 x 2,9/68					200	1018133	
<b>Thermo Twin HP*</b> * Integrierte Leerrohre für Kabel 	2x32 x 2,9-2x32 x 3,5/140	PE-Xa + EVOH	PEX-Schaum	PE-HD	max. 95 °C / 6 bar	200	1093894	
	2x40 x 3,7-2x32 x 3,5/175					200	1093895	

HEIZEN UND KÜHLEN

**Verbindungstechnik und Werkzeuge**

	<b>Wipex Übergangs-nippel</b> 	<b>Ecoflex Übergangs-nippel</b> 	<b>Quick &amp; Easy</b> 				
Zubehör	PN6 + Grafitpaste + Aufspreizzange + Inbus 	PN6 + Grafitpaste + Inbus 	PN6 + Grafitpaste + Inbus 	Aufweitwerkzeuge M18 6 bar 	M18 VLD 	Ringe natural 	weiß 
Gummi-Endkappe							

	<input type="checkbox"/>			<input type="checkbox"/>	<input type="checkbox"/>	<input type="checkbox"/>	
	<input type="checkbox"/>				<input type="checkbox"/>	<input type="checkbox"/>	
		<input type="checkbox"/>				<input type="checkbox"/>	
		<input type="checkbox"/>				<input type="checkbox"/>	
		<input type="checkbox"/>		<input type="checkbox"/>			
	<input type="checkbox"/>			<input type="checkbox"/>			<input type="checkbox"/>
	<input type="checkbox"/>			<input type="checkbox"/>			<input type="checkbox"/>
	<input type="checkbox"/>			<input type="checkbox"/>	<input type="checkbox"/>	<input type="checkbox"/>	
	<input type="checkbox"/>			<input type="checkbox"/>	<input type="checkbox"/>	<input type="checkbox"/>	
		<input type="checkbox"/>			<input type="checkbox"/>	<input type="checkbox"/>	
	<input type="checkbox"/>			<input type="checkbox"/>			<input type="checkbox"/>
	<input type="checkbox"/>			<input type="checkbox"/>			<input type="checkbox"/>
	<input type="checkbox"/>			<input type="checkbox"/>	<input type="checkbox"/>	<input type="checkbox"/>	
	<input type="checkbox"/>			<input type="checkbox"/>	<input type="checkbox"/>	<input type="checkbox"/>	
		<input type="checkbox"/>			<input type="checkbox"/>	<input type="checkbox"/>	
	<input type="checkbox"/>			<input type="checkbox"/>			<input type="checkbox"/>
	<input type="checkbox"/>			<input type="checkbox"/>			<input type="checkbox"/>
	<input type="checkbox"/>			<input type="checkbox"/>	<input type="checkbox"/>	<input type="checkbox"/>	
	<input type="checkbox"/>			<input type="checkbox"/>	<input type="checkbox"/>	<input type="checkbox"/>	
		<input type="checkbox"/>			<input type="checkbox"/>	<input type="checkbox"/>	
	<input type="checkbox"/>			<input type="checkbox"/>			<input type="checkbox"/>
	<input type="checkbox"/>			<input type="checkbox"/>			<input type="checkbox"/>
	<input type="checkbox"/>			<input type="checkbox"/>			<input type="checkbox"/>
	<input type="checkbox"/>			<input type="checkbox"/>	<input type="checkbox"/>	<input type="checkbox"/>	

Nahwärme-  
versorgung

# Verbindungstechnik, Fittings und Werkzeuge für Uponor Ecoflex Rohre

	Systemrohr	Abmessung [mm]	Mediumrohr	Dämmung	Mantelrohr	Temperatur- und Druckbelastung	Länge [m]	Artikel-Nr.	Zertifizierung	Zubehör  Gummi-Endkappe
HEIZEN UND KÜHLEN	<b>Varia Single</b> 	25 x 2,3/90	PE-Xa + EVOH	PEX-Schaum	PE-HD	max. 95 °C / 6 bar	200	1018230	CSTB System-zertifizierung	
		32 x 2,9/90					200	1018231		
		40 x 3,7/140					200	1018232		
		50 x 4,6/140					200	1018233		
		63 x 5,8/140					200	1018234		
		75 x 6,8/175					200	1018235		
		90 x 8,2/175					100	1018236		
		110 x 10,0/175					100	1018237		
		125 x 11,4/200					120	1062886		
	<b>Varia Twin</b> 	2x25 x 2,3/140	PE-Xa + EVOH	PEX-Schaum	PE-HD	max. 95 °C / 6 bar	200	1018238	CSTB System-zertifizierung	
		2x32 x 2,9/140					200	1018239		
		2x40 x 3,7/140					200	1018240		
		2x50 x 4,6/175					200	1018241		
<b>VIP Aqua Single</b> 	40 x 5,5/140	PE-Xa	VIP + PEX-Schaum	PE-HD	max. 95 °C / 10 bar	200	1119047	Kiwa System-zertifizierung DVGW, ÖVGW		
	50 x 6,9/140					200	1119048			
	63 x 8,6/140					200	1119049			
<b>VIP Aqua Twin</b> 	25 x 3,5-20 x 2,8/140	PE-Xa	VIP + PEX-Schaum	PE-HD	max. 95 °C / 10 bar	200	1119053	Kiwa System-zertifizierung DVGW, ÖVGW		
	32 x 4,4-20 x 2,8/140					200	1119054			
	40 x 5,5-25 x 3,5/140					200	1119055			
	50 x 6,9-32 x 4,4/175					200	1119056			
<b>Aqua Single</b> 	25 x 3,5/140	PE-Xa	PEX-Schaum	PE-HD	max. 95 °C / 10 bar	200	1018117	DVGW, ÖVGW		
	32 x 4,4/140					200	1018118			
	40 x 5,5/175					200	1018119			
	50 x 6,9/175					200	1018120			
	63 x 8,6/175					200	1018121			
<b>Aqua Twin</b> 	25 x 3,5-25 x 3,5/175	PE-Xa	PEX-Schaum	PE-HD	max. 95 °C / 10 bar	200	1018139	DVGW, ÖVGW		
	32 x 4,4-25 x 3,5/175					200	1018140			
	40 x 5,5-25 x 3,5/175					200	1018141			
	50 x 6,9-25 x 3,5/175					200	1018142			
<b>Quattro</b> 	2x25 x 2,3-2x25 x 3,5/175	PE-Xa + EVOH + PE-Xa	PEX-Schaum	PE-HD	max. 95 °C / 6 / 10 bar	200	1018147	DVGW, ÖVGW		
	2x32 x 2,9-2x25 x 3,5/175					200	1018148			
	2x32 x 2,9-32 x 4,4-25 x 3,5/175					200	1018149			
	2x40 x 3,7-32 x 4,4-20 x 2,8/200					100	1084891			
	2x40 x 3,7-40 x 5,5-25 x 3,5/200					100	1084890			
<b>Supra</b> 	25 x 2,3/68	PE 100-RC schwarz mit blauen Streifen	PEX-Schaum	PE-HD	20 °C / 16 bar	200	1095722	DVGW		
	32 x 2,9/68					200	1095723			
	40 x 3,7/140					200	1095724			
	50 x 4,6/140					200	1095725			
	63 x 5,8/140					200	1095726			
	75 x 6,8/175					100	1095727			
	90 x 8,2/175					100	1095728			
	110 x 10,0/200					100	1095729			
<b>Supra PLUS cable</b> Mit Frostschutzkabel 	25 x 2,3/68	PE 100-RC schwarz mit blauen Streifen	PEX-Schaum	PE-HD	20 °C / 16 bar	150	1095730	DVGW		
	32 x 2,9/68					150	1095731			
	40 x 3,7/140					150	1095734			
	50 x 4,6/140					150	1095736			
	63 x 5,8/140					150	1095737			
	75 x 6,8/175					150	1095738			
	90 x 8,2/200					100	1095739			
	110 x 10,0/200					100	1095740			



# Uponor Ecoflex Nahwärmeversorgung

Art-Nr.	Dimension	LE	VE	ME RG	Preis/ME
---------	-----------	----	----	----------	----------

## Uponor Ecoflex VIP Thermo

### Uponor Ecoflex VIP Thermo Single

 <b>1095714</b>	40x3,7/140	-	200	$\frac{m}{H7}$	<b>72,72</b>
<b>1095715</b>	50x4,6/140	-	200	$\frac{m}{H7}$	<b>90,28</b>
<b>1095716</b>	63x5,8/140	-	200	$\frac{m}{H7}$	<b>114,96</b>
<b>1095717</b>	75x6,8/140	-	200	$\frac{m}{H7}$	<b>145,02</b>
<b>1095718</b>	90x8,2/175	-	150	$\frac{m}{H7}$	<b>151,48</b>
<b>1095719</b>	110x10,0/175	-	150	$\frac{m}{H7}$	<b>168,61</b>
<b>1095720</b>	125x11,4/200	-	120	$\frac{m}{H7}$	<b>232,55</b>

### Uponor Ecoflex VIP Thermo Twin

 <b>1118580</b>	2x25x2,3/140	-	200	$\frac{m}{H7}$	<b>76,83</b>
<b>1118581</b>	2x32x2,9/140	-	200	$\frac{m}{H7}$	<b>89,72</b>
<b>1118582</b>	2x40x3,7 /175	-	200	$\frac{m}{H7}$	<b>110,04</b>
<b>1118583</b>	2x50x4,6/175	-	200	$\frac{m}{H7}$	<b>141,18</b>
<b>1118584</b>	2x63x5,8/200	-	100	$\frac{m}{H7}$	<b>165,73</b>
<b>1118585</b>	2x75x6,8/250	-	100	$\frac{m}{H7}$	<b>228,02</b>

## Uponor Ecoflex Thermo

### Uponor Ecoflex Thermo Single

 <b>1018109</b>	25x2,3/140	-	200	$\frac{m}{H1}$	<b>43,60</b>
<b>1018110</b>	32x2,9/140	-	200	$\frac{m}{H1}$	<b>53,54</b>
<b>1018111</b>	40x3,7/175	-	200	$\frac{m}{H1}$	<b>66,05</b>
<b>1018112</b>	50x4,6/175	-	200	$\frac{m}{H1}$	<b>82,10</b>
<b>1018113</b>	63x5,8/175	-	200	$\frac{m}{H1}$	<b>104,47</b>
<b>1018114</b>	75x6,8/200	-	100	$\frac{m}{H1}$	<b>128,35</b>
<b>1018115</b>	90x8,2/200	-	100	$\frac{m}{H1}$	<b>134,02</b>
<b>1018116</b>	110x10,0/200	-	100	$\frac{m}{H1}$	<b>149,22</b>

### Uponor Ecoflex Thermo Twin

 <b>1018134</b>	2x25x2,3/175	-	200	$\frac{m}{H1}$	<b>69,79</b>
<b>1018135</b>	2x32x2,9/175	-	200	$\frac{m}{H1}$	<b>81,58</b>
<b>1018136</b>	2x40x3,7 /175	-	200	$\frac{m}{H1}$	<b>100,06</b>
<b>1018137</b>	2x50x4,6/200	-	100	$\frac{m}{H1}$	<b>128,35</b>
<b>1018138</b>	2x63x5,8/200	-	100	$\frac{m}{H1}$	<b>150,62</b>

### Uponor Ecoflex Thermo Mini

 <b>1018132</b>	25x2,3/68	-	200	$\frac{m}{H1}$	<b>31,95</b>
<b>1018133</b>	32x2,9/68	-	200	$\frac{m}{H1}$	<b>39,62</b>

### Uponor Ecoflex Thermo Twin HP

 <b>1093894</b>	2x32x2,9-2x32x3,5/140	-	200	$\frac{m}{H1}$	<b>73,41</b>
<b>1093895</b>	2x40x3,7-2x32x3,5/175	-	200	$\frac{m}{H1}$	<b>95,05</b>

Art-Nr.	Dimension	LE	VE	ME RG	Preis/ME
---------	-----------	----	----	----------	----------

## Uponor Ecoflex Varia

### Uponor Ecoflex Varia Single

 <b>1018230</b>	25x2,3 /90	-	200	$\frac{m}{H6}$	<b>39,33</b>
<b>1018231</b>	32x2,9 /90	-	200	$\frac{m}{H6}$	<b>48,16</b>
<b>1018232</b>	40x3,7 /140	-	200	$\frac{m}{H6}$	<b>59,52</b>
<b>1018233</b>	50x4,6 /140	-	200	$\frac{m}{H6}$	<b>73,86</b>
<b>1018234</b>	63x5,8 /140	-	200	$\frac{m}{H6}$	<b>94,02</b>
<b>1018235</b>	75x6,8 /175	-	200	$\frac{m}{H6}$	<b>115,52</b>
<b>1018236</b>	90x8,2 /175	-	100	$\frac{m}{H6}$	<b>120,64</b>
<b>1018237</b>	110x10,0 /175	-	100	$\frac{m}{H6}$	<b>134,28</b>
<b>1062886</b>	125x11,4/200	-	120	$\frac{m}{H6}$	<b>203,07</b>

### Uponor Ecoflex Varia Twin

 <b>1018238</b>	2x25x2,3/140	-	200	$\frac{m}{H6}$	<b>62,80</b>
<b>1018239</b>	2x32x2,9/140	-	200	$\frac{m}{H6}$	<b>71,79</b>
<b>1018240</b>	2x40x3,7/140	-	200	$\frac{m}{H6}$	<b>90,06</b>
<b>1018241</b>	2x50x4,6/175	-	200	$\frac{m}{H6}$	<b>115,52</b>

# Uponor Ecoflex Nahwärmeversorgung

Art-Nr.	Dimension	LE	VE	ME RG	Preis/ME
---------	-----------	----	----	----------	----------

## Uponor Ecoflex VIP Aqua

### Uponor Ecoflex VIP Aqua Single

 <b>1119047</b>	40x5,5/140	-	200	$\frac{m}{H7}$	<b>105,91</b>
<b>1119048</b>	50x6,9/140	-	200	$\frac{m}{H7}$	<b>124,72</b>
<b>1119049</b>	63x8,6/140	-	200	$\frac{m}{H7}$	<b>157,79</b>

### Uponor Ecoflex VIP Aqua Twin

 <b>1119053</b>	25x3,5-20x2,8/140	-	200	$\frac{m}{H7}$	<b>80,69</b>
<b>1119054</b>	32x4,4-20x2,8/140	-	200	$\frac{m}{H7}$	<b>98,91</b>
<b>1119055</b>	40x5,5-25x3,5/140	-	200	$\frac{m}{H7}$	<b>117,72</b>
<b>1119056</b>	50x6,9-32x4,4/175	-	200	$\frac{m}{H7}$	<b>161,33</b>

## Uponor Ecoflex Aqua

### Uponor Ecoflex Aqua Single

 <b>1018117</b>	25x3,5/140	-	200	$\frac{m}{H1}$	<b>55,97</b>
<b>1018118</b>	32x4,4/140	-	200	$\frac{m}{H1}$	<b>61,16</b>
<b>1018119</b>	40x5,5/175	-	200	$\frac{m}{H1}$	<b>96,29</b>
<b>1018120</b>	50x6,9/175	-	200	$\frac{m}{H1}$	<b>113,34</b>
<b>1018121</b>	63x8,6/175	-	200	$\frac{m}{H1}$	<b>143,44</b>

### Uponor Ecoflex Aqua Twin

 <b>1018139</b>	25x3,5-25x3,5/175	-	200	$\frac{m}{H1}$	<b>73,35</b>
<b>1018140</b>	32x4,4-25x3,5/175	-	200	$\frac{m}{H1}$	<b>89,96</b>
<b>1018141</b>	40x5,5-25x3,5/175	-	200	$\frac{m}{H1}$	<b>107,01</b>
<b>1018142</b>	50x6,9-25x3,5/175	-	200	$\frac{m}{H1}$	<b>146,68</b>

Art-Nr.	Dimension	LE	VE	ME RG	Preis/ME
---------	-----------	----	----	----------	----------

## Uponor Ecoflex Quattro

### Uponor Ecoflex Quattro

 <b>1018147</b>	2x25x2,3-2x25x3,5/175	-	200	$\frac{m}{H1}$	<b>134,61</b>
<b>1018148</b>	2x32x2,9-2x25x3,5/175	-	200	$\frac{m}{H1}$	<b>150,38</b>
<b>1018149</b>	2x32x2,9-32x4,4-25x3,5/175	-	200	$\frac{m}{H1}$	<b>160,83</b>
<b>1084891</b>	2x40x3,7-32x4,4-20x2,8/200	-	100	$\frac{m}{H1}$	<b>168,86</b>
<b>1084890</b>	2x40x3,7-40x5,5-25x3,5/200	-	100	$\frac{m}{H1}$	<b>173,98</b>

# Uponor Ecoflex Nahwärmeversorgung

Art-Nr.	Dimension	LE	VE	ME RG	Preis/ME
---------	-----------	----	----	----------	----------

## Uponor Ecoflex Supra

### Uponor Ecoflex Supra

 <b>1095722</b>	25x2,3/68	-	200	<sup>m</sup> <sub>H1</sub>	<b>28,32</b>
<b>1095723</b>	32x2,9/68	-	200	<sup>m</sup> <sub>H1</sub>	<b>33,05</b>
<b>1095724</b>	40x3,7/140	-	200	<sup>m</sup> <sub>H1</sub>	<b>43,60</b>
<b>1095725</b>	50x4,6/140	-	200	<sup>m</sup> <sub>H1</sub>	<b>48,35</b>
<b>1095726</b>	63x5,8/140	-	200	<sup>m</sup> <sub>H1</sub>	<b>50,07</b>
<b>1095727</b>	75x6,8/175	-	150	<sup>m</sup> <sub>H1</sub>	<b>60,30</b>
<b>1095728</b>	90x8,2/175	-	100	<sup>m</sup> <sub>H1</sub>	<b>63,56</b>
<b>1095729</b>	110x10,0/200	-	100	<sup>m</sup> <sub>H1</sub>	<b>85,33</b>

Art-Nr.	Dimension	LE	VE	ME RG	Preis/ME
---------	-----------	----	----	----------	----------

## Uponor Ecoflex Supra PLUS

### Uponor Ecoflex Supra PLUS cable

 <b>1095730</b>	25x2,3/68 1x10W/m	-	150	<sup>m</sup> <sub>H1</sub>	<b>56,77</b>
<b>1095731</b>	32x2,9/68 1x10W/m	-	150	<sup>m</sup> <sub>H1</sub>	<b>63,13</b>
<b>1095734</b>	40x3,7/140 1x10W/m	-	150	<sup>m</sup> <sub>H1</sub>	<b>74,46</b>
<b>1095736</b>	50x4,6/140 1x10W/m	-	150	<sup>m</sup> <sub>H1</sub>	<b>79,79</b>
<b>1095737</b>	63x5,8/140 1x10W/m	-	150	<sup>m</sup> <sub>H1</sub>	<b>82,92</b>
<b>1095738</b>	75x6,8/175 1x10W/m	-	150	<sup>m</sup> <sub>H1</sub>	<b>103,58</b>
<b>1095739</b>	90x8,2/200 1x10W/m	-	100	<sup>m</sup> <sub>H1</sub>	<b>137,99</b>
<b>1095740</b>	110x10,0/200 1x10W/m	-	100	<sup>m</sup> <sub>H1</sub>	<b>150,28</b>

### Uponor Ecoflex Supra PLUS Set

 <b>1120124</b>	25+32/68	-	1	Set H2	<b>455,68</b>
<b>1120126</b>	40+50+63/140	-	1	Set H2	<b>505,81</b>
<b>1120127</b>	75/175	-	1	Set H2	<b>585,26</b>
<b>1120128</b>	90+110/200	-	1	Set H2	<b>640,96</b>

### Uponor Ecoflex Supra PLUS Regler 150

 <b>1120123</b>			50	1	St. H2	<b>404,10</b>
---	--	--	----	---	-----------	---------------

### Uponor Ecoflex Supra PLUS Kabel-Set S1

 <b>1042310</b>			1	1	St. H2	<b>80,83</b>
--	--	--	---	---	-----------	--------------

### Uponor Ecoflex Supra PLUS Kabel-Set S2

 <b>1042311</b>			1	1	St. H2	<b>181,15</b>
--	--	--	---	---	-----------	---------------

### Uponor Ecoflex Supra PLUS T-Set

 <b>1061641</b>	140/90/68		5	1	St. H2	<b>654,92</b>
<b>1061642</b>	200/175/140		3	1	St. H2	<b>752,28</b>

### Uponor Ecoflex Reduzierring

 <b>1060991</b>	200/68		8	1	St. H2	<b>12,54</b>
--	--------	--	---	---	-----------	--------------



# Uponor Wipex

Art-Nr.	Dimension	LE	VE	ME RG	Preis/ME
 <b>1018328</b>	25x2,3-G1	40	1	St. H5	<b>66,81</b>
<b>1018329</b>	32x2,9-G1	20	1	St. H5	<b>73,10</b>
<b>1018330</b>	40x3,7-G1 ¼	10	1	St. H5	<b>90,08</b>
<b>1018331</b>	50x4,6-G1 ¼	10	1	St. H5	<b>104,18</b>
<b>1018332</b>	63x5,8-G2	8	1	St. H5	<b>131,05</b>
<b>1018333</b>	75x6,8-G2	6	1	St. H5	<b>178,54</b>
<b>1018334</b>	90x8,2-G3	4	1	St. H5	<b>247,59</b>
<b>1018335</b>	110x10,0-G3	3	1	St. H5	<b>297,11</b>

## Uponor Ecoflex Übergangsnippel PN6

 <b>1078368</b>	125x11,4-R4	-	1	St. H5	<b>481,70</b>
--	-------------	---	---	-----------	---------------

## Uponor Ecoflex Übergangsnippel PN10

 <b>1091505</b>	20x2,8-¾"	10	1	St. H5	<b>63,17</b>
--	-----------	----	---	-----------	--------------

## Uponor Wipex Übergangsnippel PN10

 <b>1018336</b>	25x3,5-G1	40	1	St. H5	<b>69,03</b>
<b>1018338</b>	32x4,4-G1	20	1	St. H5	<b>76,69</b>
<b>1018339</b>	40x5,5-G1 ¼	10	1	St. H5	<b>95,15</b>
<b>1018340</b>	50x6,9-G1 ¼	10	1	St. H5	<b>104,30</b>
<b>1018341</b>	63x8,6-G2	8	1	St. H5	<b>130,58</b>

## Uponor Wipex Kupplung PN6

 <b>1042972</b>	25x2,3-25x2,3	30	1	St. H5	<b>132,97</b>
<b>1042973</b>	32x2,9-32x2,9	25	1	St. H5	<b>144,97</b>
<b>1042980</b>	40x3,7-40x3,7	15	1	St. H5	<b>171,05</b>
<b>1042984</b>	50x4,6-50x4,6	10	1	St. H5	<b>196,56</b>
<b>1042981</b>	63x5,8-63x5,8	5	1	St. H5	<b>247,61</b>
<b>1042985</b>	75x6,8-75x6,8	3	1	St. H5	<b>352,62</b>
<b>1042986</b>	90x8,2-90x8,2	4	1	St. H5	<b>483,21</b>
<b>1042987</b>	110x10-110x10	2	1	St. H5	<b>583,76</b>

## Uponor Ecoflex Kupplung PN6

 <b>1078365</b>	125x11,4-125x11,4	-	1	St. H5	<b>675,30</b>
--	-------------------	---	---	-----------	---------------

## Uponor Wipex Kupplung PN10

 <b>1042970</b>	25x3,5-25x3,5	40	1	St. H5	<b>134,76</b>
<b>1042974</b>	32x4,4-32x4,4	25	1	St. H5	<b>147,82</b>
<b>1042979</b>	40x5,5-40x5,5	15	1	St. H5	<b>174,07</b>
<b>1042983</b>	50x6,9-50x6,9	10	1	St. H5	<b>199,59</b>
<b>1042982</b>	63x8,6-63x8,6	4	1	St. H5	<b>283,61</b>

Art-Nr.	Dimension	LE	VE	ME RG	Preis/ME
 <b>1018345</b>	G1-G1-G1	20	1	St. H5	<b>39,93</b>
<b>1018346</b>	G1 ¼-G1 ¼-G1 ¼	10	1	St. H5	<b>53,13</b>
<b>1018347</b>	G2-G2-G2	4	1	St. H5	<b>78,93</b>
<b>1018348</b>	G3-G3-G3	3	1	St. H5	<b>183,10</b>

## Uponor Ecoflex T-Stück

 <b>1078367</b>	Rp4-Rp4-Rp4	-	1	St. H5	<b>213,09</b>
--	-------------	---	---	-----------	---------------

## Uponor Wipex Winkel

 <b>1018350</b>	G1-G1	20	1	St. H5	<b>41,11</b>
<b>1018351</b>	G1 ¼-G1 ¼	15	1	St. H5	<b>43,74</b>
<b>1018352</b>	G2-G2	5	1	St. H5	<b>71,73</b>
<b>1018353</b>	G3-G3	2	1	St. H5	<b>156,04</b>

## Uponor Ecoflex Winkel

 <b>1078366</b>	Rp4-Rp4	-	1	St. H5	<b>211,56</b>
--	---------	---	---	-----------	---------------

## Uponor Wipex Gewindemuffe

 <b>1018355</b>	G1-G1	40	1	St. H5	<b>31,66</b>
<b>1018356</b>	G1 ¼-G1 ¼	25	1	St. H5	<b>38,56</b>
<b>1018357</b>	G2-G2	15	1	St. H5	<b>59,43</b>
<b>1018358</b>	G3-G3	10	1	St. H5	<b>97,83</b>

## Uponor Wipex Reduzierung

 <b>1018368</b>	G1 ¼-G1	25	1	St. H5	<b>28,80</b>
<b>1018369</b>	G1 ½-G1 ¼	25	1	St. H5	<b>65,59</b>
<b>1018371</b>	G2-G1	15	1	St. H5	<b>92,59</b>
<b>1018372</b>	G2-G1 ¼	15	1	St. H5	<b>86,43</b>
<b>1018373</b>	G2 ½-G2	6	1	St. H5	<b>151,54</b>
<b>1018374</b>	G3-G1	6	1	St. H5	<b>151,57</b>
<b>1018375</b>	G3-G1 ¼	10	1	St. H5	<b>157,53</b>
<b>1018376</b>	G3-G2	10	1	St. H5	<b>159,02</b>
<b>1009052</b>	G4-G3	6	1	St. H5	<b>211,55</b>

## Uponor Ecoflex Reduzierung

 <b>1078369</b>	R4-G3	6	1	St. H5	<b>160,56</b>
--	-------	---	---	-----------	---------------

# Uponor Wipex

Art-Nr.	Dimension	LE	VE	ME RG	Preis/ME
 <b>1018359</b>	F25/4-85/G1	10	1	St. H5	<b>183,05</b>
<b>1018360</b>	F32/4-100/G1 ¼	5	1	St. H5	<b>226,56</b>
<b>1018361</b>	F40/4-110/G1 ½	5	1	St. H5	<b>246,34</b>
<b>1018362</b>	F50/4-125/G2	4	1	St. H5	<b>342,14</b>
<b>1018363</b>	F65/8-145/2 ½	3	1	St. H5	<b>438,19</b>
<b>1018364</b>	F80/8-160/G3	3	1	St. H5	<b>465,21</b>
<b>1018365</b>	F100/8-180/G4	3	1	St. H5	<b>619,78</b>

## Uponor Ecoflex Gewindeflansch

 <b>1078370</b>	F100/8-180/Rp4	-	1	St. H5	<b>310,63</b>
--	----------------	---	---	-----------	---------------

## Uponor Wipex Drehnippel

 <b>1045455</b>	G1	20	1	St. H5	<b>83,30</b>
<b>1045456</b>	G1 ¼-G1	20	1	St. H5	<b>86,43</b>
<b>1045457</b>	G1 ¼	15	1	St. H5	<b>91,84</b>
<b>1065442</b>	G1¼ 120mm	8	1	St. H5	<b>122,18</b>
<b>1045458</b>	G2-G1 ¼	10	1	St. H5	<b>137,18</b>
<b>1045459</b>	G2	10	1	St. H5	<b>141,21</b>
<b>1065444</b>	G2 120mm	3	1	St. H5	<b>183,06</b>
<b>1045460</b>	G3-G2	3	1	St. H5	<b>279,07</b>
<b>1045461</b>	G3	2	1	St. H5	<b>472,73</b>

## Uponor Wipex Fixpunktmuffe

 <b>1018302</b>	G1	30	1	St. H5	<b>78,33</b>
<b>1018303</b>	G1 ¼	10	1	St. H5	<b>99,50</b>
<b>1018304</b>	G2	5	1	St. H5	<b>160,53</b>
<b>1018305</b>	G3	5	1	St. H5	<b>303,16</b>

Art-Nr.	Dimension	LE	VE	ME RG	Preis/ME
 <b>1094013</b>	EU+GOST 25x2,3-26,9	-	1	St. H5	<b>122,29</b>
<b>1094014</b>	EU 32x2,9-33,7	-	1	St. H5	<b>133,32</b>
<b>1094015</b>	EU 40x3,7-42,4	-	1	St. H5	<b>157,37</b>
<b>1094016</b>	EU 50x4,6-48,3	-	1	St. H5	<b>180,85</b>
<b>1094017</b>	EU 63x5,8-60,3	-	1	St. H5	<b>227,79</b>
<b>1094018</b>	EU+GOST 75x6,8-76,1	-	1	St. H5	<b>324,45</b>
<b>1094019</b>	EU+GOST 90x8,2-88,9	-	1	St. H5	<b>444,57</b>
<b>1094020</b>	EU 110x10,0-114,3	-	1	St. H5	<b>537,03</b>
<b>1094021</b>	EU+GOST 125x11,4-114,3	-	1	St. H5	<b>818,74</b>

## Uponor Wipex - MLC Presskupplung S-Press PN6

 <b>1060058</b>	32x2,9-32x3,0	25	1	St. H5	<b>110,90</b>
--	---------------	----	---	-----------	---------------

## Uponor Wipex - MLC Presskupplung S-Press PN6

 <b>1060059</b>	40x3,7-40x4,0	15	1	St. H5	<b>132,37</b>
<b>1060060</b>	50x4,6-50x4,5	10	1	St. H5	<b>190,58</b>

## Uponor Wipex RS Adapter PN6

 <b>1047013</b>	DR 63x5,8 RS2	240	1	St. H5	<b>130,42</b>
---	---------------	-----	---	-----------	---------------

## Uponor Wipex Aufspreizzange

 <b>1046407</b>	1 - 1 ½	25	1	St. NET	<b>40,69</b>
--	---------	----	---	------------	--------------

# Uponor Q&E

Art-Nr.	Dimension	LE	VE	ME RG	Preis/ME
---------	-----------	----	----	----------	----------

## Uponor Q&E Sicherungsring white

 1057455	25	300	20	St. F1	1,31
1057456	32	150	10	St. F1	2,48

## Uponor Q&E Ring natural

 1045464	40	80	5	St. H3	3,93
1045489	50	70	5	St. H3	5,49
1045490	63	35	5	St. H3	8,65
1085087	75	18	2	St. H3	18,93

## Uponor Q&E Winkel PPSU

 1008681	25-25	25	5	St. H3	13,18
1001245	32-32	10	1	St. H3	26,35
1008683	40-40	10	1	St. H3	41,32
1042859	50-50	5	1	St. H3	65,98
1042858	63-63	3	1	St. H3	98,87
1085080	75-75	2	1	St. H3	157,59

## Uponor Q&E Kupplung PPSU

 1008671	25-25	50	5	St. H3	10,42
1001235	32-32	15	1	St. H3	16,16
1008673	40-40	10	1	St. H3	31,46
1042866	50-50	10	1	St. H3	47,15
1042865	63-63	5	1	St. H3	81,83
1085084	75-75	10	1	St. H3	157,59

## Uponor Q&E Reduzierkupplung PPSU

 1001240	32-25	20	1	St. H3	24,39
1008678	40-32	10	1	St. H3	31,46
1042879	50-32	10	1	St. H3	47,15
1042867	50-40	10	1	St. H3	47,15
1042877	63-50	5	1	St. H3	78,66
1085085	75-63	10	1	St. H3	157,59

## Uponor Q&E T-Stück PPSU

 1008686	25-25-25	20	5	St. H3	16,61
1001250	32-32-32	10	1	St. H3	33,79
1008688	40-40-40	5	1	St. H3	55,09
1042861	50-50-50	3	1	St. H3	94,29
1042860	63-63-63	2	1	St. H3	125,80
1085081	75-75-75	2	1	St. H3	189,10

Art-Nr.	Dimension	LE	VE	ME RG	Preis/ME
---------	-----------	----	----	----------	----------

## Uponor Q&E Reduzier-T-Stück PPSU

 1008712	25-32-25	15	1	St. H3	33,79
1001426	32-25-25	15	1	St. H3	33,79
1001428	32-25-32	15	1	St. H3	33,79
1008713	32-40-32	10	1	St. H3	61,17
1008708	40-25-32	5	1	St. H3	61,17
1008695	40-25-40	5	1	St. H3	61,17
1008709	40-32-32	5	1	St. H3	61,17
1008696	40-32-40	5	1	St. H3	61,17
1042876	50-25-40	4	1	St. H3	94,29
1042864	50-25-50	4	1	St. H3	94,29
1042863	50-32-50	4	1	St. H3	94,29
1042871	63-25-50	2	1	St. H3	131,39
1042873	63-25-63	2	1	St. H3	131,39
1042870	63-32-63	2	1	St. H3	131,39
1085083	75-25-75	4	1	St. H3	188,52

## Uponor Q&E Übergangsnippel PL

 1023007	25-R $\frac{3}{4}$ "MT	70	5	St. H3	23,57
1047191	32-R1"MT	10	1	St. H3	39,33

## Uponor Q&E Übergangsnippel PL/DR

 1085077	40-R1 $\frac{1}{4}$ "MT	16	1	St. H3	62,91
1085076	50-R1 $\frac{1}{2}$ "MT	8	1	St. H3	78,66
1085075	63-R2"MT	6	1	St. H3	117,87
1085074	75-R2 $\frac{1}{2}$ "MT	6	1	St. H3	228,83

## Uponor Q&E Winkel mit Innengewinde PL

 1023026	25-G $\frac{3}{4}$ "FT	35	5	St. H3	23,57
---	------------------------	----	---	-----------	-------

## Uponor Q&E Übergangsmuffe PL

 1023012	25-Rp $\frac{3}{4}$ "FT	40	5	St. H3	23,57
---	-------------------------	----	---	-----------	-------

# Uponor Ecoflex Systemzubehör

Art-Nr.	Dimension	LE	VE	ME RG	Preis/ME
 <b>1018316</b>	25+32+40/68	-	1	St. H2	<b>31,56</b>
<b>1018246</b>	25+32+40/90	-	1	St. H2	<b>38,18</b>
<b>1018315</b>	25+28+32/140	-	1	St. H2	<b>40,68</b>
<b>1018313</b>	32+40+50/175	-	1	St. H2	<b>55,18</b>
<b>1018314</b>	40+50+63/140	-	1	St. H2	<b>45,86</b>
<b>1095801</b>	63+75+90/140	-	1	St. H2	<b>53,13</b>
<b>1018312</b>	63+75/175	-	1	St. H2	<b>59,78</b>
<b>1018310</b>	75+90+110/200	-	1	St. H2	<b>78,73</b>
<b>1018311</b>	90+110/175	-	1	St. H2	<b>76,22</b>
<b>1067757</b>	125/200	-	1	St. H2	<b>94,34</b>

## Uponor Ecoflex Gummi-Endkappe, Twin

 <b>1119374</b>	18-22+25-28+32/140	-	1	St. H2	<b>56,49</b>
<b>1018245</b>	25+32+40/140	-	1	St. H2	<b>64,79</b>
<b>1018309</b>	25+32+40/175	-	1	St. H2	<b>79,71</b>
<b>1018308</b>	25+32+50/175	-	1	St. H2	<b>82,50</b>
<b>1018307</b>	40+50+63/200	-	1	St. H2	<b>85,13</b>
<b>1088979</b>	75+90/250	-	1	St. H2	<b>105,48</b>

## Uponor Ecoflex Gummi-Endkappe, Quattro

 <b>1086838</b>	20+25+32/140	-	1	St. H2	<b>95,87</b>
<b>1018306</b>	18-22+25-28+32/175	-	1	St. H2	<b>95,87</b>
<b>1094252</b>	25-28+32+40/175	-	1	St. H2	<b>103,39</b>
<b>1034308</b>	18-28+32+40/200	-	1	St. H2	<b>146,29</b>

## Uponor Ecoflex T-Isoliersatz

 <b>1060986</b>	140/90/68	5	1	St. H2	<b>442,12</b>
<b>1060982</b>	200/175/140	4	1	St. H2	<b>521,14</b>
<b>1121805</b>	250/200/175/140	3	1	St. H2	<b>1008,86</b>

## Uponor Ecoflex Eckisoliersatz

 <b>1060985</b>	200/175/140	3	1	St. H2	<b>407,89</b>
--	-------------	---	---	-----------	---------------

## Uponor Ecoflex Längsisoliersatz

 <b>1060984</b>	200/175/140	6	1	St. H2	<b>404,09</b>
<b>1121806</b>	250	4	1	St. H2	<b>510,93</b>

## Uponor Ecoflex Reduzierring

 <b>1060991</b>	200/68	8	1	St. H2	<b>12,54</b>
<b>1060990</b>	200/90	8	1	St. H2	<b>18,04</b>
<b>1085107</b>	200/160	12	1	St. H2	<b>17,41</b>
<b>1121807</b>	250/250	-	1	St. H2	<b>20,51</b>
<b>1121808</b>	250/200	-	1	St. H2	<b>20,51</b>
<b>1121809</b>	250/175	-	1	St. H2	<b>20,51</b>
<b>1122070</b>	250/140	-	-	St. H2	<b>20,51</b>

Art-Nr.	Dimension	LE	VE	ME RG	Preis/ME
 <b>1007355</b>	200/175/140	-	1	St. H2	<b>877,78</b>

## Uponor Ecoflex Schacht

 <b>1018326</b>	6x140/175/200	3	1	St. H2	<b>1323,75</b>
<b>1018327</b>	8x140/175/200	3	1	St. H2	<b>1407,11</b>
<b>1084576</b>	2x250-6x140/175/200	1	1	St. H2	<b>1909,08</b>
<b>1084577</b>	4x250-4x140/175/200	1	1	St. H2	<b>2923,07</b>
<b>1084578</b>	6x250-2x140/175/200	1	1	St. H2	<b>3386,12</b>

## Uponor Ecoflex Dichtband

 <b>1018382</b>	50mm x 10m	-	1	St. H2	<b>124,43</b>
--	------------	---	---	-----------	---------------

## Uponor Ecoflex Schrumpfschlauch

 <b>1018379</b>	140	-	1	St. H2	<b>40,82</b>
<b>1018380</b>	175/200	-	1	St. H2	<b>45,70</b>
<b>1084575</b>	250	15	1	St. H2	<b>86,11</b>

## Uponor Ecoflex Hauseinführungsbogen Single

 <b>1118765</b>	50x4,6/140	-	1	St. H2	<b>558,20</b>
<b>1118766</b>	63x5,8/140	-	1	St. H2	<b>585,12</b>
<b>1118767</b>	75x6,8/140	-	1	St. H2	<b>981,89</b>
<b>NEU</b> <b>1118768</b>	90x8,2/200	-	1	St. H2	<b>1894,56</b>
<b>NEU</b> <b>1118769</b>	110x10/200	-	1	St. H2	<b>1999,68</b>
<b>NEU</b> <b>1118770</b>	125x11,4/200	-	1	St. H2	<b>2025,85</b>

Lieferzeit auf Anfrage.

## Uponor Ecoflex Hauseinführungsbogen Twin

 <b>1118771</b>	2x25x2,3/140	-	1	St. H2	<b>511,13</b>
<b>1118772</b>	2x32x2,9/140	-	1	St. H2	<b>538,03</b>
<b>1118773</b>	2x40x3,7/160	-	1	St. H2	<b>632,19</b>
<b>1118774</b>	2x50x4,6/200	-	1	St. H2	<b>775,32</b>
<b>1118775</b>	2x63x5,8/200	-	1	St. H2	<b>981,89</b>
<b>1118776</b>	2x75x6,8/250	-	1	St. H2	<b>1318,18</b>

Lieferzeit auf Anfrage.

## Uponor Ecoflex Mauerdurchführung DWD

 <b>1007358</b>	68	-	1	St. H2	<b>280,06</b>
<b>1007359</b>	90	-	1	St. H2	<b>324,65</b>
<b>1007360</b>	140	-	1	St. H2	<b>369,25</b>
<b>1007361</b>	175	-	1	St. H2	<b>479,34</b>
<b>1007362</b>	200	-	1	St. H2	<b>617,32</b>
<b>1091429</b>	250	-	1	St. H2	<b>693,93</b>

# Uponor Ecoflex Systemzubehör

Art-Nr.	Dimension	LE	VE	ME RG	Preis/ME
<b>Uponor Ecoflex Ergänzungssatz NDW</b>					
 1007365	140	-	1	St. H2	217,36
1007366	175	-	1	St. H2	263,32
1007367	200	-	1	St. H2	390,18
1091430	250	-	1	St. H2	470,96

## Uponor Ecoflex Faserzementrohr DWD

 1007368	68	-	1	St. H2	199,26
1007370	140	-	1	St. H2	204,84
1007371	175	-	1	St. H2	234,10
1007372	200	-	1	St. H2	321,87
1091431	250	-	1	St. H2	387,38

## Uponor Ecoflex Epoxidharz Set für DWD

 1007373	1,1 kg/3,5m <sup>2</sup>	-	1	Set H2	144,90
---	--------------------------	---	---	-----------	--------

## Uponor Ecoflex Mauerdurchführung NDW

 1018267	68+90	-	1	St. H2	54,62
1018269	140	-	1	St. H2	60,19
1018268	175+200	-	1	St. H2	66,59
1083871	250	16	1	St. H2	116,79

## Uponor Ecoflex Labyrinthdichtung NDW

 1034202	140	40	1	St. H2	66,59
1034203	175	30	1	St. H2	69,96
1034204	200	20	1	St. H2	80,23
1090415	250	-	1	St. H2	107,01

## Uponor Ecoflex Schrumpfmanschette

 1036014	140+175+200-700mm	-	1	St. H2	356,70
---	-------------------	---	---	-----------	--------

## Uponor Ecoflex Schrumpfband

 1093120	160mm x 10m	30	1	St. H2	163,74
---	-------------	----	---	-----------	--------

## Uponor Ecoflex Trassenwarnband, rot

 1018385	40mm x 250m	-	1	St. H2	64,24
1105785	40mm x 30m	-	1	St. H2	22,87

Art-Nr.	Dimension	LE	VE	ME RG	Preis/ME
<b>Uponor Ecoflex Abroller type1</b>					
 1036645		-	1	St. NET	2692,48

## Uponor Multi Rohrschneider

 1089677	32-40	12	1	St. NET	99,02
1089779	Multi Ersatzklinge 32-40	50	1	St. NET	47,77

## Uponor Multi Rohrschneider

 1089675	25-63	12	1	St. NET	94,43
1089777	Multi Ersatzschneidrad 25-63	50	1	St. NET	10,89

## Uponor Multi Rohrschneider

 1089676	50-125	8	1	St. NET	176,34
1089778	Multi Ersatzschneidrad 50-125	50	1	St. NET	13,55

## Uponor MLC Universalentgrater

 1060167		50	1	St. NET	20,14
---	--	----	---	------------	-------

## Uponor Wipex Aufsprezzange

 1046407	1 - 1 1/2	25	1	St. NET	40,69
---	-----------	----	---	------------	-------

## Uponor Q&E Grafitpaste

 1005017	100g	-	1	St. NET	30,27
---	------	---	---	------------	-------

## Uponor Ecoflex Dichtpaste

 1060996	290ml	-	1	St. H2	25,01
---	-------	---	---	-----------	-------

## Uponor Ecoflex Spreiznieten

 1021997		-	1	St. H2	0,33
---	--	---	---	-----------	------

## Uponor Ecoflex Schrauben-Set

 1021999		-	1	St. H2	1,12
---	--	---	---	-----------	------

## Uponor Ecoflex Schrauben-Set

 1060995	M6x30 (34pcs)	-	1	St. H2	20,81
---	---------------	---	---	-----------	-------

## Uponor Ecoflex Supra PLUS Frostschutzkabel

 1044136	10W/m	-	1	m H2	23,76
---	-------	---	---	---------	-------

# Uponor Ecoflex Mietwerkzeuge

## Uponor RNT Ecoflex Aufweitwerkzeug rent DACH Q&E



**1087649** M18 6BAR 25/32/40 - 1 St. Miet-Tarif  
NET B

## Uponor RNT Ecoflex Aufweitwerkzeug rent DACH Q&E



**1087650** M18 10BAR 25/32 - 1 St. Miet-Tarif  
NET B

## Uponor RNT Ecoflex Aufweitwerkzeug rent DACH Q&E



**1087651** M18 VLD 40-75 - 1 St. Miet-Tarif  
NET A

## Uponor RNT Ecoflex Abroller rent DACH



**1087652** type 1 - 1 St. Miet-Tarif  
NET A

## Uponor Ecoflex Rundungswerkz. rent DACH



**1085661** 125 - 1 St. Miet-Tarif  
NET C

## Miet-Tarife für Uponor Ecoflex Mietwerkzeuge

- Unkomplizierter Verleih von Uponor Ecoflex Werkzeugen
- Einfache Anforderung mit dem Mietservice-Auftragsformular

Miet-Tarif Gruppe	Tagesmiete		
	3-9 Tage	ab dem 10. Tag	ab dem 30. Tag
A	17,00 €	12,00 €	10,00 €
B	15,00 €	9,00 €	8,00 €
C	10,00 €	8,00 €	6,00 €

Falls Sie die Uponor Montagewerkzeuge kaufen möchten, wenden Sie sich bitte an unseren für Sie zuständigen Außendienstmitarbeiter.



# Uponor Werkzeuge

Art-Nr.	Dimension	LE	VE	ME RG	Preis/ME
---------	-----------	----	----	----------	----------

## Abrollen

### Uponor MLC Rohrrichter



1010512	14-25	-	1	St. NET	576,28
---------	-------	---	---	------------	--------

### Uponor Multi Teleskop-Abrollvorrichtung



1058662		-	1	St. NET	554,04
---------	--	---	---	------------	--------

### Uponor Multi Abrollvorrichtung



1006255	120-960m	-	1	St. NET	685,35
---------	----------	---	---	------------	--------

### Uponor Magna Abrollvorrichtung



1006256	25-640m	-	1	St. NET	1294,53
---------	---------	---	---	------------	---------

### Uponor Magna Abrollvorrichtung



1135500		18	1	St. NET	438,76
---------	--	----	---	------------	--------

## Vorbereitung, Schneiden, Biegen

### Uponor Multi Rohrschneider



1089674	12-25		36	1	St. NET	109,02
---------	-------	--	----	---	------------	--------

### Uponor Multi Ersatzklinge



1089776	12-25		150	1	St. NET	23,75
---------	-------	--	-----	---	------------	-------

### Uponor Multi Rohrschneider



1089677	32-40		12	1	St. NET	99,02
---------	-------	--	----	---	------------	-------

### Uponor Multi Ersatzklinge



1089779	32-40		50	1	St. NET	47,77
---------	-------	--	----	---	------------	-------

### Uponor Multi Rohrschneider



1089675	25-63		12	1	St. NET	94,43
---------	-------	--	----	---	------------	-------

### Uponor Multi Ersatzschneidrad



1089777	25-63		50	1	St. NET	10,89
---------	-------	--	----	---	------------	-------

### Uponor Multi Rohrschneider



1089676	50-125		8	1	St. NET	176,34
---------	--------	--	---	---	------------	--------

### Uponor Multi Ersatzschneidrad



1089778	50-125		50	1	St. NET	13,55
---------	--------	--	----	---	------------	-------

### Uponor Flex Rohrschneider PEX



1089673	12-25		36	1	St. NET	34,99
---------	-------	--	----	---	------------	-------

### Uponor Flex Ersatzklinge PEX



1089780	12-25		150	1	St. NET	23,75
---------	-------	--	-----	---	------------	-------

### Uponor MLC Rohrabschneider und Entgrater



1014334	63-110		-	1	St. NET	777,64
---------	--------	--	---	---	------------	--------

### Uponor MLC Schneidrad für Werkzeugset



1014320	63-110		-	1	St. U2	95,60
---------	--------	--	---	---	-----------	-------

# Uponor Werkzeuge

Art-Nr.	Dimension	LE	VE	ME RG	Preis/ME
---------	-----------	----	----	----------	----------

## Vorbereitung, Schneiden, Biegen

### Uponor MLC Entgrater

 <b>1006952</b>	14	50	1	St. NET	<b>36,09</b>
<b>1006830</b>	16	50	1	St. NET	<b>37,92</b>
<b>1015749</b>	20	1200	1	St. NET	<b>41,53</b>
<b>1015756</b>	25	960	1	St. NET	<b>43,89</b>
<b>1015762</b>	32	900	1	St. NET	<b>47,77</b>

### Uponor MLC Entgrater

 <b>1006638</b>	40	600	1	St. NET	<b>49,16</b>
<b>1015808</b>	50	600	1	St. NET	<b>58,32</b>
<b>1014339</b>	63	600	1	St. NET	<b>71,49</b>
<b>1014344</b>	75	600	1	St. NET	<b>105,95</b>

### Uponor MLC Kombientgrater

 <b>1015739</b>	16/20/25	60	1	St. NET	<b>66,10</b>
--	----------	----	---	------------	--------------

### Uponor MLC Universalentgrater

 <b>1060167</b>		50	1	St. NET	<b>20,14</b>
--	--	----	---	------------	--------------

Art-Nr.	Dimension	LE	VE	ME RG	Preis/ME
---------	-----------	----	----	----------	----------

### Uponor MLC Biegefeder innen

 <b>1013727</b>	14	1000	1	St. NET	<b>14,36</b>
<b>1013729</b>	16	100	1	St. NET	<b>15,27</b>
<b>1013734</b>	20	75	1	St. NET	<b>19,45</b>
<b>1013737</b>	25	50	1	St. NET	<b>19,80</b>
<b>1013739</b>	32	40	1	St. NET	<b>29,86</b>

### Uponor MLC Biegefeder außen

 <b>1006639</b>	14	550	1	St. NET	<b>17,71</b>
<b>1006640</b>	16	55	1	St. NET	<b>19,15</b>
<b>1013792</b>	20	45	1	St. NET	<b>24,38</b>
<b>1013794</b>	25	45	1	St. NET	<b>24,92</b>

### Uponor Uni Pipe PLUS Biegezange

 <b>1071925</b>	16-32	100	1	St. NET	<b>574,90</b>
--	-------	-----	---	------------	---------------

### Uponor Uni Pipe PLUS Biegesegment

 <b>1120408</b>	R32 16	10	1	St. NET	<b>115,60</b>
<b>1120409</b>	R40 20	10	1	St. NET	<b>115,60</b>
<b>1120410</b>	R62,5 25	10	1	St. NET	<b>115,60</b>
<b>1120411</b>	R80 32	10	1	St. NET	<b>265,87</b>



# Uponor Werkzeuge

Art-Nr.	Dimension	LE	VE	ME RG	Preis/ME
---------	-----------	----	----	----------	----------

## Pressen

### Uponor S-Press Handzange (ohne Wechseleinsätze)

 <b>1015764</b>	14-20	100	1	St. NET	<b>457,40</b>
--	-------	-----	---	------------	---------------

### Uponor S-Press Wechseleinsätze

 <b>1015776</b>	14	400	1	St. NET	<b>71,38</b>
<b>1015777</b>	16	50	1	St. NET	<b>71,38</b>
<b>1015780</b>	20	50	1	St. NET	<b>71,38</b>

### Uponor S-Press Akkumaschine UP 110 (ohne Pressbacken)



<b>1083612</b>		20	1	Set NET	<b>2291,11</b>
----------------	--	----	---	------------	----------------

### Uponor S-Press Ersatzakku UP 110

 <b>1083608</b>		10	1	St. NET	<b>401,33</b>
--	--	----	---	------------	---------------

### Uponor S-Press Ersatzladegerät

 <b>1083610</b>	Mini2, UP110	72	1	St. NET	<b>352,70</b>
--	--------------	----	---	------------	---------------

### Uponor S-Press Werkzeugkoffer UP110



<b>1083602</b>		20	1	St. NET	<b>222,15</b>
----------------	--	----	---	------------	---------------

### Uponor S-Press Ersatzakku UP 75

 <b>1006949</b>		12	1	St. NET	<b>247,18</b>
--	--	----	---	------------	---------------

### Uponor S-Press Ersatzladegerät UP 75

 <b>1006950</b>		10	1	St. NET	<b>253,20</b>
--	--	----	---	------------	---------------

Art-Nr.	Dimension	LE	VE	ME RG	Preis/ME
---------	-----------	----	----	----------	----------

### Uponor S-Press Maschine UP75 EL (ohne Pressbacken)



<b>1007082</b>		20	1	St. NET	<b>1499,76</b>
----------------	--	----	---	------------	----------------

### Uponor S-Press Werkzeugkoffer blau UP 75



<b>1084676</b>		20	1	St. NET	<b>259,68</b>
----------------	--	----	---	------------	---------------

### Uponor S-Press Pressbacken UPP1



<b>1007083</b>	14	280	1	St. NET	<b>184,65</b>
<b>1007084</b>	16	216	1	St. NET	<b>184,65</b>
<b>1007086</b>	20	-	1	St. NET	<b>184,65</b>
<b>1007087</b>	25	-	1	St. NET	<b>184,65</b>
<b>1007088</b>	32	-	1	St. NET	<b>184,65</b>

### Uponor S-Press Pressbacken UPP1



<b>1015768</b>	40	108	1	St. NET	<b>237,43</b>
<b>1015792</b>	50	108	1	St. NET	<b>247,18</b>

### Uponor S-Press Basispressbacke



<b>1046545</b>	63-110	-	1	St. NET	<b>537,51</b>
----------------	--------	---	---	------------	---------------

### Uponor S-Press Pressschlinge



<b>1046541</b>	63	72	1	St. NET	<b>913,19</b>
<b>1046542</b>	75	72	1	St. NET	<b>1112,30</b>
<b>1046543</b>	90	72	1	St. NET	<b>1471,93</b>
<b>1046544</b>	110	54	1	St. NET	<b>1569,15</b>

# Uponor Werkzeuge

Art-Nr.	Dimension	LE	VE	ME RG	Preis/ME
---------	-----------	----	----	----------	----------

## Werkzeugset Verbundrohre

### Uponor Werkzeugpaket Typ A - MLC für Pressmaschinen UP 75 und UP 110



- Uponor Multi Rohrschneider 14-25
- Uponor Multi Rohrschneider 25-63
- Uponor Biegefeder außen MLC 16
- Uponor Biegefeder außen MLC 20
- Uponor Biegefeder außen MLC 25
- Uponor S-Press Pressbacken UPP1 16
- Uponor S-Press Pressbacken UPP1 20
- Uponor S-Press Pressbacken UPP1 25
- Uponor SPI Press Werkzeugkoffer

1013782		-	1	Set NET	640,21
---------	--	---	---	------------	--------

Art-Nr.	Dimension	LE	VE	ME RG	Preis/ME
---------	-----------	----	----	----------	----------

### Uponor Werkzeugpaket Typ B - MLC für Pressmaschinen UP 75 und UP 110



- Uponor Multi Rohrschneider 14-25
- Uponor Multi Rohrschneider 25-63
- Uponor Biegefeder außen MLC 16
- Uponor Biegefeder außen MLC 20
- Uponor Biegefeder außen MLC 25
- Uponor S-Press Pressbacken UPP1 16
- Uponor S-Press Pressbacken UPP1 20
- Uponor S-Press Pressbacken UPP1 25
- Uponor S-Press Pressbacken UPP1 32
- Uponor SPI Press Werkzeugkoffer

1013783		-	1	Set NET	798,51
---------	--	---	---	------------	--------

## Uponor Pressen

### Uponor S-Press Akkumaschine Mini<sup>2</sup> mit KSP0 Pressbacken



1083586	16/20/25/32	30	1	Set NET	2263,17
---------	-------------	----	---	------------	---------

### Uponor S-Press Akkumaschine Mini<sup>2</sup> mit KSP0 Pressbacken



1083594	16/20/25	25	1	Set NET	2055,29
---------	----------	----	---	------------	---------

### Uponor S-Press Akkumaschine Mini<sup>2</sup> (ohne Pressbacken)



1087260		-	1	St. NET	1096,87
---------	--	---	---	------------	---------

### Uponor S-Press Ersatzakku Mini<sup>2</sup>



1083605		48	1	St. NET	336,06
---------	--	----	---	------------	--------

### Uponor S-Press Ersatzakku Mini



1015703		120	1	St. NET	248,59
---------	--	-----	---	------------	--------

### Uponor S-Press Werkzeugkoffer Mini<sup>2</sup>



1083599		25	1	St. NET	118,04
---------	--	----	---	------------	--------

### Uponor S-Press Pressbacken Mini KSP0



1007090	14	5	1	St. NET	215,22
1007091	16	5	1	St. NET	215,22
1007093	20	5	1	St. NET	215,22
1007094	25	5	1	St. NET	215,22
1007095	32	5	1	St. NET	215,22

# Uponor Werkzeuge

Art-Nr.	Dimension	LE	VE	ME RG	Preis/ME
---------	-----------	----	----	----------	----------

## Aufweiten

### Uponor Minitec Aufweitwerkzeug

 <b>1006247</b>	9,9x1,1	11	1	Set NET	<b>399,92</b>
--	---------	----	---	------------	---------------

### Uponor Q&E Aufweitwerkzeug mit Aufweitk. M12/

 <b>1119376</b>	16RS/20/25 6bar	-	1	Set NET	<b>847,30</b>
<b>1119375</b>	6bar 9,9RS/20	-	1	Set NET	<b>702,82</b>

### Uponor Q&E Aufweitkopf M12/Rapid Seal

 <b>1119380</b>	9,9x1,1	-	1	St. NET	<b>144,50</b>
--	---------	---	---	------------	---------------

### Uponor Q&E Aufweitkopf M12/M18

 <b>1057184</b>	14/15x2,5	-	1	St. NET	<b>156,88</b>
<b>1057185</b>	17/18x2,5	-	1	St. NET	<b>151,35</b>

### Uponor Q&E Aufweitkopf M12/M18/Rapid Seal

 <b>1119381</b>	16x1,8/2,0/2,2	-	1	St. NET	<b>144,50</b>
<b>1119382</b>	20x1,9/2,0	-	1	St. NET	<b>144,50</b>
<b>1119383</b>	20x2,8	-	1	St. NET	<b>144,50</b>
<b>1119384</b>	25x2,3	-	1	St. NET	<b>144,50</b>
<b>1119385</b>	25x3,5	-	1	St. NET	<b>144,50</b>
<b>1119386</b>	32x2,9	-	1	St. NET	<b>144,50</b>

### Uponor Q&E Ersatzakku für Aufweitwerkz. M12

 <b>1061185</b>	4Ah	12	1	St. NET	<b>151,35</b>
--	-----	----	---	------------	---------------

Art-Nr.	Dimension	LE	VE	ME RG	Preis/ME
---------	-----------	----	----	----------	----------

### Uponor Q&E Aufweitwerkzeug mit Aufweitk. M18 6bar

 <b>1063908</b>	16/20/25/32	-	1	Set NET	<b>1501,57</b>
--	-------------	---	---	------------	----------------

### Uponor Q&E Aufweitwerkzeug mit Aufweitk. M18 10bar

 <b>1063909</b>	16/20/25/H32	-	1	Set NET	<b>1585,15</b>
--	--------------	---	---	------------	----------------

### Uponor Q&E Aufweitkopf M18 H

 <b>1057182</b>	32x2,9/4,4	-	1	St. NET	<b>168,03</b>
<b>1057183</b>	40x3,7	-	1	St. NET	<b>168,03</b>

### Uponor Q&E Aufweitwerkzeug M18 VLD PEX

 <b>1085099</b>	40-75	-	1	St. NET	<b>3410,03</b>
--	-------	---	---	------------	----------------

### Uponor Q&E Aufweitkopf VLD

 <b>1085095</b>	40x3,7/5,5	-	1	St. NET	<b>662,28</b>
<b>1085096</b>	50x4,6/6,9	-	1	St. NET	<b>677,67</b>
<b>1085097</b>	63x5,8/8,6	-	1	St. NET	<b>714,96</b>
<b>1085098</b>	75x6,8/10,3	-	1	St. NET	<b>764,35</b>

### Uponor Q&E Akku für Aufweitwerkzeug M18 PEX

 <b>1085100</b>	5,0Ah	-	1	St. NET	<b>358,29</b>
--	-------	---	---	------------	---------------

### Uponor Q&E Ladegerät Aufweitwerkzeug M12/M18 PEX

 <b>1085101</b>	220-240V/50-60Hz	-	1	St. NET	<b>167,16</b>
--	------------------	---	---	------------	---------------

### Uponor Q&E Grafitpaste

 <b>1005017</b>	100g	-	1	St. NET	<b>30,27</b>
--	------	---	---	------------	--------------

# Uponor Werkzeuge

Art-Nr.	Dimension	LE	VE	ME RG	Preis/ME
---------	-----------	----	----	----------	----------

## Befestigen

### Uponor Multi Rohrhalterung



<b>1088066</b>		-	1	St. NET	<b>300,55</b>
----------------	--	---	---	------------	---------------

### Uponor Siccus 14 Schneidegerät



<b>1006290</b>	14mm 230V	-	1	St. NET	<b>279,13</b>
----------------	-----------	---	---	------------	---------------

### Uponor Siccus Mini Heißschneidgerät



<b>NEU 1139796</b>	10mm 230V	20	1	St. NET	<b>440,09</b>
--------------------	-----------	----	---	------------	---------------

### Uponor Tacker Werkzeug



<b>1119039</b>	14-20mm	50	1	St. NET	<b>280,97</b>
----------------	---------	----	---	------------	---------------

### Uponor Classic clipmaster



<b>1006295</b>	16/17mm l=920mm	100	1	St. NET	<b>341,43</b>
<b>1006309</b>	20mm l=920mm	-	1	St. NET	<b>497,70</b>

### Uponor Classic Ersatzteilstfeder



<b>1007349</b>		-	1	St. U1	<b>10,98</b>
----------------	--	---	---	-----------	--------------

### Uponor Classic Drillgerät f.Mattenbinder



<b>1006243</b>	l=320mm	50	1	St. NET	<b>26,79</b>
----------------	---------	----	---	------------	--------------

Art-Nr.	Dimension	LE	VE	ME RG	Preis/ME
---------	-----------	----	----	----------	----------

## Sonstige

### Uponor Rapex Press-Backe



<b>1006330</b>	14x2	-	1	St. NET	<b>254,31</b>
<b>1006332</b>	16x2	8	1	St. NET	<b>254,31</b>
<b>1006343</b>	17x2	-	1	St. NET	<b>254,31</b>
<b>1006334</b>	20x2,3	-	1	St. NET	<b>271,65</b>
<b>1006344</b>	25x2,3	-	1	St. NET	<b>271,65</b>

### Uponor Smart Aqua Biegezange f. Schiene



<b>1015424</b>	2m	-	1	St. NET	<b>173,55</b>
----------------	----	---	---	------------	---------------

# Allgemeine Liefer- und Zahlungsbedingungen der Uponor GmbH

## 1. Allgemeines

- 1.1 Unsere Lieferungen und Leistungen erfolgen ausschließlich aufgrund der nachstehenden Bedingungen. Abweichungen haben nur dann Gültigkeit, wenn sie schriftlich von uns bestätigt werden.
- 1.2 Mit der Erteilung des Auftrages, spätestens mit der Entgegennahme der Ware erkennt der Käufer unsere Allgemeinen Liefer- und Zahlungsbedingungen an. Abweichende Bedingungen des Käufers, die wir nicht ausdrücklich schriftlich anerkennen, sind für uns unverbindlich, auch wenn wir ihnen nicht ausdrücklich widersprechen.
- 1.3 Diese Bedingungen gelten auch für zukünftige Lieferungen aufgrund schriftlicher oder fernmündlicher Bestellungen des Käufers.
- 1.4 Alle Bestellungen, Aufträge und Vereinbarungen werden für uns erst mit Zugang unserer schriftlichen Auftragsbestätigung beim Käufer oder, falls eine Auftragsbestätigung nicht erteilt wird, mit Lieferung der Ware verbindlich. Mündliche oder telefonische Zusagen oder sonstige Abreden einschließlich etwaiger Ergänzungen, Abänderungen und Nebenabreden zu bereits angenommenen Bestellungen sowie durch unsere Vertreter getätigte Verkäufe sind für uns erst verbindlich, sobald und soweit sie von uns nachträglich schriftlich bestätigt sind.
- 1.5 Für Maschinen und Werkzeugverkäufe gelten ergänzend unsere diesbezüglichen Zusatzbedingungen.

## 2. Preise und Lieferung

- 2.1 Unsere Listen- und Angebotspreise sind freibleibend und unverbindlich, sofern nicht eine bestimmte Geltungsdauer schriftlich vereinbart ist. Alle Preise verstehen sich in EURO ab Werk ohne Verpackung, Verladung, Fracht und Montage zuzüglich der jeweils geltenden Mehrwertsteuer. Bei einer Direkt-/ Streckenlieferung mit einem Warenbestellwert unter 500 € netto wird ein Mindermengenzuschlag von 20 € zzgl. gesetzlicher Mehrwertsteuer pro Lieferung berechnet. Bei Lieferungen an das Lager des Käufers erfolgt die Lieferung grundsätzlich in vollständigen Verpackungseinheiten gemäß der aktuellen Preisliste. Müssen wir für die Bearbeitung einer Bestellung eine oder mehrere Verpackungseinheiten anbrechen, weil der Käufer lediglich eine anteilige Verpackungseinheit eines oder mehrerer Artikel bestellt hat, werden dem Käufer für diesen Mehraufwand pro Bestellung pauschal 20 € zzgl. gesetzlicher Mehrwertsteuer zusätzlich berechnet.
- 2.2 Unabhängig davon, ob eine Versendung ab Werk erfolgt und wer die Frachtkosten trägt, hat der Käufer alle Gefahren des Verlustes oder der Beschädigung der Ware von dem Zeitpunkt an zu tragen, zu dem ihm die Ware – ohne Verladung auf das abholende Beförderungsmittel – ab Werk zur Verfügung gestellt wurde.
- 2.3 Etwa notwendige Verpackung wird zum Selbstkostenpreis berechnet und nicht zurückgenommen.
- 2.4 Alle Liefertermine und Fristen gelten nur als annähernd, sofern sie nicht schriftlich ausdrücklich als verbindlich zugesagt werden. Wünscht der Käufer Lieferung zu einem späteren als dem ursprünglich vereinbarten Termin, können wir die Vertragsleistung zum vereinbarten Liefertermin in Rechnung stellen und die Ware auf Kosten des Käufers einlagern. Erfolgt eine Lagerung in unserem Werk, sind wir berechtigt, ein Lagergeld in Höhe von 2,5‰ des Auftragsnettowerts für jeden angefangenen Monat der Lagerung zu verlangen.
- 2.5 Teillieferungen sind zulässig.
- 2.6 Bestellt der Käufer Ware auf Abruf, so gilt der Abruf spätestens sechs Monate nach der Bestellung als erfolgt, es sei denn, es ist schriftlich eine andere Vereinbarung getroffen worden.
- 2.7 Betriebsstörungen, Kriegszustand, Arbeitskämpfe oder sonstige Ereignisse höherer Gewalt bei uns oder unseren Lieferanten berechtigen uns, die Lieferung um die betreffende Zeitdauer hinauszuschieben. Wir werden dem Käufer solche Hindernisse unverzüglich mitteilen. Erhöhen sich infolge derartiger unvorhergesehener Umstände unsere Kosten, so sind wir zu entsprechenden Preiskorrekturen berechtigt, insbesondere zur Berechnung der Tagespreise am Versandtag.

- 2.8 Begründete Zweifel an der Kreditwürdigkeit des Käufers berechtigen uns, vom Käufer für unsere Lieferungen Sicherheit oder Vorkasse zu verlangen oder vom Vertrag zurückzutreten. Schadensersatzansprüche des Käufers sind in diesen Fällen ausgeschlossen.

## 3. Zahlungsbedingungen

- 3.1 Zahlungstermine und Zahlungsfristen werden gesondert vereinbart. Bei Zielüberschreitungen werden bankübliche Zinsen, mindestens aber die gesetzlichen Verzugszinsen berechnet.
- 3.2 Die Annahme von Wechseln und Schecks erfolgt stets zahlungshalber; erst die Einlösung gilt als Zahlung. Die Annahme von Wechseln bedarf der gesonderten Vereinbarung. Diskontspesen und Kosten gehen zu Lasten des Kunden.
- 3.3 Unsere Angestellten, Vertreter oder Vertriebspartner sind nicht zur Entgegennahme von Zahlungen für uns berechtigt. Ausnahmen bedürfen unserer ausdrücklichen schriftlichen Einwilligung.
- 3.4 Mit von uns nicht anerkannten oder nicht rechtskräftig festgestellten Gegenansprüchen kann der Käufer weder aufrechnen noch wegen dieser Ansprüche ein Zurückbehaltungsrecht geltend machen.
- 3.5 Hält der Käufer die Zahlungsbedingungen nicht ein oder treten berechtigte Zweifel an der Kreditwürdigkeit des Käufers auf, so werden alle unsere Forderungen aus der gesamten Lieferbeziehung zum Käufer sofort fällig.

## 4. Eigentumsvorbehalt

- 4.1 Die gelieferten Waren bleiben bis zur vollständigen Bezahlung sämtlicher Lieferungen nebst allen Nebenforderungen aus der gesamten Geschäftsbeziehung einschließlich der Einlösung etwa von uns in Zahlung genommener Schecks oder Wechsel unser Eigentum. Unsere Forderungen gehen nicht durch Aufnahme in einen kontokorrentmäßigen Saldo und dessen Anerkennung unter.
- 4.2 Der Käufer hat die Vorbehaltsware ausreichend zu kennzeichnen und sie angemessen gegen Feuer und Einbruch-Diebstahl zu versichern.
- 4.3 Eine etwaige Be- oder Verarbeitung der Vorbehaltsware nimmt der Käufer für uns vor, ohne dass uns daraus Verpflichtungen entstehen. Bei Verarbeitung oder Verbindung der Vorbehaltsware mit anderen, nicht uns gehörenden Waren steht uns das dabei entstehende Miteigentum an der neuen Sache zu, und zwar im Verhältnis des Wertes der Vorbehaltsware zu der übrigen verarbeiteten Ware im Zeitpunkt der Verarbeitung oder Verbindung. Erwirbt der Käufer das Alleineigentum an der neuen Sache, so räumt er uns im Verhältnis des Wertes der verarbeiteten bzw. verbundenen Vorbehaltsware zum Gesamtwert der neuen Sache Miteigentum an der neuen Sache ein und verwahrt sie unentgeltlich für uns.
- 4.4 Der Käufer ist zur Weiterveräußerung der Vorbehaltsware im normalen Geschäftsverkehr berechtigt. Eine Verpfändung, Sicherungsübereignung oder ein Verleih ist ihm jedoch nicht gestattet. Veräußert der Käufer Vorbehaltsware weiter, so tritt er uns bereits jetzt seine künftigen Forderungen aus der Weiterveräußerung gegen seine Kunden mit allen Nebenrechten – einschließlich etwaiger Saldoforderungen – sicherungshalber ab, ohne dass es noch späterer besonderer Erklärungen bedarf. Wir nehmen die Abtretung an.
- 4.5 Wird die Vorbehaltsware von dem Käufer mit Grundstücken verbunden, so tritt der Käufer schon jetzt die daraus entstehende Forderung auf Vergütung in Höhe des Wertes der Vorbehaltsware mit allen Nebenrechten einschließlich des Rechts auf Einräumung einer Sicherungshypothek ab. Die Abtretung hat Vorrang vor sonstigen dem Käufer gegenüber seinem Kunden etwa zustehenden Ansprüchen. Wir nehmen die Abtretung an.
- 4.6 Wird die Vorbehaltsware zusammen mit anderen Waren – gleich ob ohne oder nach Verarbeitung oder Verbindung – weiterveräußert, so tritt der Käufer seine Forderungen aus der Weiterveräußerung der Vorbehaltsware ebenfalls an uns ab, jedoch nur in Höhe des Wertes der Vorbehaltsware, die zusammen mit den anderen Waren Gegenstand des Verkaufs ist. Entsprechendes gilt für etwaige Saldoforderungen. Wir nehmen die Abtretung an.

- 4.7 Bis auf Widerruf ist der Käufer zur Einziehung der abgetretenen Forderungen befugt. Wir sind zum Widerruf dieser Einziehungsbefugnis berechtigt, wenn der Käufer seinen Verpflichtungen uns gegenüber nicht nachkommt oder sonstige wichtige Gründe vorliegen, insbesondere Zahlungseinstellung, Eröffnung eines Insolvenzverfahrens, Wechselprotest oder vergleichbare Anhaltspunkte, die eine Zahlungsunfähigkeit des Käufers nahelegen. Im Falle des Widerrufs hat der Käufer uns die zur Einziehung unserer Forderungen erforderlichen Angaben über die abgetretenen Forderungen zu machen und den Schuldnern die Abtretung mitzuteilen.
- 4.8 Übersteigt der realisierbare Wert der uns nach Maßgabe der vorstehenden Ziffern zur Verfügung gestellten Sicherheiten die zu sichernden Forderungen aus der gesamten Geschäftsbeziehung um mehr als 20 %, sind wir auf Verlangen des Käufers insoweit zur Freigabe von Sicherheiten nach eigener Wahl verpflichtet.
- 4.9 Über das etwaige Abhandenkommen sowie die Beschädigung oder Zerstörung von Vorbehaltsware hat uns der Käufer unverzüglich zu unterrichten. Dasselbe gilt für Zwangsvollstreckungsmaßnahmen Dritter in die Vorbehaltsware oder in die abgetretenen Forderungen. Der Käufer hat uns alle Informationen zur Verfügung zu stellen, die wir benötigen, um unsere Rechte Dritten gegenüber geltend zu machen.
- 4.10 Die Geltendmachung von Eigentumsvorbehaltsrechten durch uns gilt nicht als Rücktritt vom Vertrag.
5. Haftung für Mängel
- 5.1 Die in dieser Produktinformation oder sonstigen Prospekten, Werbematerialien, Beschreibungen usw. enthaltenen Angaben beruhen auf dem aktuellen Stand unserer Erkenntnisse und Erfahrungen. Anwendung, Verwendung und Verarbeitung erfolgen außerhalb unserer Kontrollmöglichkeiten. Alle Angaben sind deswegen nur als ungefähre Angaben und nicht als Beschaffenheitsangaben anzusehen. Sie begründen keine Beschaffenheits- oder Haltbarkeitsgarantie. Die Eignung unserer Produkte für den vorgesehenen Anwendungszweck ist durch den Käufer zu prüfen.
- 5.2 Der Käufer hat gelieferte Ware unverzüglich zu untersuchen. Offenkundige Mängel sind uns spätestens innerhalb von acht Tagen nach Empfang der Ware schriftlich mitzuteilen, andere Mängel unverzüglich nach ihrem Auftreten. Unsere Haftung für Mängel, die nicht rechtzeitig angezeigt worden sind, ist ausgeschlossen.
- 5.3 Nimmt der Käufer mangelhafte Ware an, obwohl er den Mangel kennt oder infolge grober Fahrlässigkeit nicht kennt, so stehen ihm Ansprüche und Rechte wegen dieser Mängel nur zu, wenn er sich diese bei der Annahme vorbehalten hat. Bei begründeten Beanstandungen bessern wir nach unserer Wahl die mangelhaften Liefergegenstände nach oder liefern Ersatz. Aus- und Einbaukosten sowie sonstige mit der Nacherfüllung verbundenen Kosten, insbesondere Transport-, Wege-, Arbeits- und Materialkosten, übernehmen wir nicht, wenn und soweit solche Kosten dadurch entstanden sind oder sich erhöht haben, daß der Besteller den Liefergegenstand eingebaut oder sonst verarbeitet hat, obwohl Mängel erkennbar waren.
- 5.4 Ansprüche wegen Mängel der Sache bestehen nicht bei nur unerheblicher Abweichung des Liefergegenstandes von der vereinbarten Beschaffenheit, einer unerheblichen Beeinträchtigung der Brauchbarkeit, im Falle natürlicher Abnutzung, Beschädigung durch Gewalt, durch unsachgemäße Behandlung oder Verwendung, übermäßige Beanspruchung, elementare Einflüsse oder im Falle eigenmächtiger, selbst vorgenommener oder bei Dritten veranlaßter Eingriffe des Käufers an der Ware.
- 5.5 Alle Ansprüche wegen Mängel der Sache verjähren in zwölf Monaten ab Lieferung. Abweichend davon gilt für Mängel an Liefergegenständen, die entsprechend ihrer üblichen Verwendungsweise für ein Bauwerk verwendet worden sind und dessen Mangelhaftigkeit verursacht haben, die gesetzliche Verjährungsfrist.
- 5.6 Für Schadensersatz wegen Mängel der Sache haften wir ausschließlich im Rahmen der nachstehenden Ziffer 6.
- 5.7 Ansprüche des Käufers aus weitergehenden Erklärungen, die wir ausdrücklich und schriftlich im Zusammenhang mit Lieferungen abgegeben haben, bleiben von den vorstehenden Bestimmungen unberührt.
6. Haftung für Schadensersatzansprüche
- 6.1 Wir haften nicht für Verzögerungsschäden und für Schäden, die auf einer leicht fahrlässigen Pflichtverletzung oder Handlung beruhen. Dies gilt nicht, wenn die Pflichtverletzung oder Handlung zu einer Verletzung des Lebens, des Körpers oder der Gesundheit führt oder in der Verletzung wesentlicher vertraglicher Pflichten besteht.
- 6.2 Wir haften nicht für leicht fahrlässiges Handeln unserer Organe und/oder leitender Angestellter und nicht für leicht und/oder grob fahrlässiges Handeln nicht leitender Angestellter, sofern keine den Vertragszweck gefährdenden wesentlichen Pflichten verletzt werden und die Pflichtverletzung nicht zu einer Verletzung des Lebens, des Körpers oder der Gesundheit führt.
- 6.3 Unsere Haftung ist in allen Fällen begrenzt auf die bei Vertragsabschluss vorhersehbaren, typischen Schäden, die aus der Pflichtverletzung oder Handlung resultieren.
- 6.4 Mit der vorstehenden Regelung ist eine Änderung der Beweislast zum Nachteil des Käufers nicht verbunden.
- 6.5 Ansprüche des Käufers aus sonstigen Erklärungen, die wir ausdrücklich und schriftlich im Zusammenhang mit Lieferungen abgegeben haben, sowie zwingende gesetzliche Ansprüche des Käufers, insbesondere nach Maßgabe des Produkthaftpflichtgesetzes, bleiben unberührt.
7. Gerichtsstand
- Gerichtsstand ist für beide Teile Haßfurt, sofern der Käufer Kaufmann, juristische Person des öffentlichen Rechts oder öffentlich-rechtliches Sondervermögen ist. Das gilt auch für Scheck- und Wechselprozesse. Wir sind darüber hinaus berechtigt, den Käufer an seinem allgemeinen Gerichtsstand zu verklagen.
8. Schlussbestimmungen
- 8.1 Es gilt ausschließlich deutsches Recht mit Ausnahme der Regeln über das internationale Privatrecht und des UN-Abkommens über den internationalen Warenkauf (CISG).
- 8.2 Wir sind berechtigt, die uns im Rahmen der Geschäftsbeziehung oder im Zusammenhang mit ihr zugänglich gemachten Daten über den Käufer im Sinne des Bundesdatenschutzgesetzes zu verarbeiten.
- 8.3 Falls einzelne Bestimmungen dieser Allgemeinen Liefer- und Zahlungsbedingungen unwirksam sind oder werden sollten, wird die Wirksamkeit der übrigen Bestimmungen dadurch nicht berührt.
- 8.4 Durch diese Allgemeinen Liefer- und Zahlungsbedingungen werden alle früher geltenden Geschäftsbedingungen aufgehoben und ersetzt.

## Online verfügbare Versionen zum Download:



**Uponor Gesamtpreisliste Deutschland 2024**  
<https://www.uponor.com/de-de/preisliste-2024>



**Online Produktkatalog**



**Uponor Downloadcenter**



→ **Uponor Videoanleitungen in YouTube:**



**Klicken Sie doch mal rein!**



- **Auszug aus dem umfangreichen Uponor Programm als Kurzpreisliste**  
**Das vollständige Uponor Portfolio ist online als Gesamtpreisliste verfügbar (siehe QR-Code oben)**
- Alle Preise sind unverbindliche Preisempfehlungen in Euro zzgl. der gültigen Mehrwertsteuer.
- Die angegebenen Werkzeugpreise sind Nettopreise.
- Es gelten unsere Verkaufs- und Lieferbedingungen.
- Nachstehende Preise verstehen sich ab Werk ausschließlich Transportverpackung.
- Technische und inhaltliche Änderungen behalten wir uns vor.
- Mehr Infos unter [www.uponor.com](http://www.uponor.com)

Alle rechtlichen und technischen Informationen wurden nach bestem Wissen sorgfältig zusammengestellt. Fehler können dennoch nicht vollständig ausgeschlossen und hierfür keine Haftung übernommen werden. Das Werk ist einschließlich aller seiner Teile urheberrechtlich geschützt. Jede Verwertung außerhalb der durch das Urhebergesetz zugelassenen Ausnahmen ist ohne Zustimmung der Uponor GmbH nicht gestattet. Insbesondere Vervielfältigungen, der Nachdruck, Bearbeitungen, Speicherung und Verarbeitung in elektronischen Systemen, Übersetzungen und Mikroverfilmungen behalten wir uns vor. Technische Änderungen vorbehalten.

# Moving > Water

**Uponor Kundenservice\* +49 (0)32 221 090 866**

**TECHNISCHE HOTLINE - VERTRIEB - ANGEBOTE - PROJEKTIERUNG**

\* Anruf aus dem Mobilnetz max. 9 ct./Min.

# uponor

**Uponor GmbH**

Industriestraße 56

97437 Haßfurt

[www.uponor.com](http://www.uponor.com)

**E-Mail:** [kundenservice@uponor.com](mailto:kundenservice@uponor.com)

1142295\_01/2024\_MaC\_Änderungen vorbehalten.