



**Trinkwasserinstallation  
Flächenheizung/-kühlung  
Nahwärmeversorgung**

**uponor**

**Kurzpreisliste 2022  
Deutschland**

Auszug aus dem umfangreichen Programm als **Kurzpreisliste Deutschland 2022**.  
Das vollständige Uponor Portfolio ist online als **Gesamtpreisliste** verfügbar.



**Download der vollständigen Preisliste  
Deutschland 2022**



**Online Produktkatalog**



**Uponor Downloadcenter**

- **Auszug aus dem umfangreichen Programm als Kurzpreisliste Deutschland 2022.**  
**Das vollständige Uponor Portfolio ist online als Gesamtpreisliste verfügbar.**
- Alle Preise sind unverbindliche Preisempfehlungen in Euro zzgl. der gültigen Mehrwertsteuer.
- Die angegebenen Werkzeugpreise sind Nettopreise.
- Es gelten unsere Verkaufs- und Lieferbedingungen.
- Nachstehende Preise verstehen sich ab Werk ausschließlich Transportverpackung.
- Technische und inhaltliche Änderungen behalten wir uns vor.
- Mehr Infos unter [www.uponor.de](http://www.uponor.de)

Alle rechtlichen und technischen Informationen wurden nach bestem Wissen sorgfältig zusammengestellt. Fehler können dennoch nicht vollständig ausgeschlossen und hierfür keine Haftung übernommen werden. Das Werk ist einschließlich aller seiner Teile urheberrechtlich geschützt. Jede Verwertung außerhalb der durch das Urhebergesetz zugelassenen Ausnahmen ist ohne Zustimmung der Uponor GmbH nicht gestattet. Insbesondere Vervielfältigungen, der Nachdruck, Bearbeitungen, Speicherung und Verarbeitung in elektronischen Systemen, Übersetzungen und Mikroverfilmungen behalten wir uns vor.  
Technische Änderungen vorbehalten.

## Installationssysteme

Trinkwasser- und Heizungsinstallation . . . . . 6  
Uponor Verbundrohrsysteme



KLICK - DIREKT  
ZUM KAPITEL

## Flächenheizung/-kühlung

Flächenheiz-/kühlsysteme für Boden, Wand und Decke . . . . . 22  
Verteiler und -zubehör . . . . . 40  
Raumtemperaturregelung . . . . . 46  
Vorlauftemperaturregelung / Pumpengruppen . . . . . 50

## Nahwärmeversorgung

Flexible vorgedämmte Rohrleitungen  
und Verbindungstechniken  
für erdverlegte Nahwärmenetze . . . . . 58

## Werkzeuge

Werkzeuge für die Verarbeitung von Installationsrohren  
und Rohren in der Flächenheizung/-kühlung . . . . . 67

## Anhang

Ersetzungs- und Änderungsliste zur neuen Preisliste 2022 . . . . . 73  
Allgemeine Geschäftsbedingungen



# Installationsrohre und Verbindungstechnik

Unterschiedliche Montagesituationen und Einsatzbereiche verlangen nach perfekt darauf abgestimmten Fitting-konzepten. Deshalb entwickelt und produziert Uponor nicht nur Rohre, sondern gleichzeitig auch die passenden, auf den jeweiligen Einsatz zugeschnittenen Fittingsysteme. Das Uponor Fittingprogramm mit Kupplungen, Winkeln, T-Stücken und einer Vielzahl von praxisgerechten Systemkomponenten schafft die Voraussetzung für eine schnelle, sichere und praxisgerechte Montage und übertrifft dabei die Anforderungen, die an hygienische Trinkwasser-Installationen und zeitgemäße Heizungsverrohrungen gestellt werden.

## Uponor Fittingsystem

Dimension/ Farbcode	Verbund- rohrtyp
 14	MLC
 16	Uni Pipe PLUS
 20	Uni Pipe PLUS
 25	Uni Pipe PLUS
 32	Uni Pipe PLUS
 40	MLC
 50	MLC
 63	MLC
 75	MLC
 90	MLC
 110	MLC

## Eigenschaften

Dimensionsabhängige Farbcodierung

Sichtfenster zur Kontrolle der Einstecktiefe

Verpresstkennzeichnung  
durch Ablösen der Folie von der Presshülse

Verpresstkennzeichnung  
durch Ablösung des Anschlagringes

Verpresstkennzeichnung  
durch Pressabdruck auf Presshülse









Montage ohne Entgraten

Montage ohne Kalibrieren

Verbinder unverpresst undicht

Integrierte Pressfunktion

Modulares Fittingsystem

	Press-Fitting, Metall				Press-Fitting, Verbund		RTM Fitting	Uni-C 1/2"	Uni-X 3/4"
	S-Press PLUS	S-Press		RS	S-Press PLUS, PPSU	S-Press PPSU			
									
		•						•	•
	•	•		•	•		•	•	•
	•			•	•		•	•	•
	•			•	•		•		•
	•		•	•		•			
			•	•		•			
			•	•		•			
			•	•		•			
				•					
				•					
	•	•	•	•	•	•	•		
	•	•	•	•	•	•	•		
	•			<sup>2)</sup>	•				
		•		<sup>3)</sup>					
	•		•	<sup>2)</sup>	•	•			
	•	•		<sup>1)</sup>	•		•	•	•
	•	•	•	•	•	•		•	•
	•	•	•	•	•	•			
				•			•		

<sup>1)</sup> bis Dimension 32  
<sup>2)</sup> ab Dimension 20  
<sup>3)</sup> Dimension 16

# Uponor Uni Pipe PLUS

Art-Nr.	Dimension	LE	VE	ME RG	Preis/ME
 <b>1060783</b>	16x2,0 3m	75	3	$\frac{m}{E1}$	<b>6,64</b>
<b>1059572</b>	16x2,0 5m	125	5	$\frac{m}{E1}$	<b>6,32</b>
<b>1060784</b>	20x2,25 3m	51	3	$\frac{m}{E1}$	<b>8,57</b>
<b>1059573</b>	20x2,25 5m	85	5	$\frac{m}{E1}$	<b>8,17</b>
<b>1060785</b>	25x2,5 3m	30	3	$\frac{m}{E1}$	<b>12,52</b>
<b>1059574</b>	25x2,5 5m	50	5	$\frac{m}{E1}$	<b>12,07</b>
<b>1060786</b>	32x3,0 3m	21	3	$\frac{m}{E1}$	<b>17,91</b>
<b>1059575</b>	32x3,0 5m	35	5	$\frac{m}{E1}$	<b>17,14</b>

## Uponor MLC Rohr weiß S

 <b>1013448</b>	40x4,0 3m	12	3	$\frac{m}{E1}$	<b>33,36</b>
<b>1013446</b>	40x4,0 5m	20	5	$\frac{m}{E1}$	<b>32,78</b>
<b>1021980</b>	50x4,5 3m	12	3	$\frac{m}{E1}$	<b>47,30</b>
<b>1013449</b>	50x4,5 5m	20	5	$\frac{m}{E1}$	<b>46,79</b>
<b>1021981</b>	63x6,0 3m	9	3	$\frac{m}{E1}$	<b>59,99</b>
<b>1013451</b>	63x6,0 5m	15	5	$\frac{m}{E1}$	<b>58,56</b>
<b>1013453</b>	75x7,5 5m	255	5	$\frac{m}{E1}$	<b>94,78</b>
<b>1013455</b>	90x8,5 5m	255	5	$\frac{m}{E1}$	<b>103,26</b>
<b>1013457</b>	110x10,0 5m	165	5	$\frac{m}{E1}$	<b>122,95</b>

## Uponor Uni Pipe PLUS weiß

 <b>1059576</b>	16x2,0 100m	2000	100	$\frac{m}{E1}$	<b>3,21</b>
<b>1092653</b>	16x2,0 120m	2400	120	$\frac{m}{E1}$	<b>3,21</b>
<b>1059577</b>	16x2,0 200m	2600	200	$\frac{m}{E1}$	<b>3,21</b>
<b>1059578</b>	16x2,0 500m	3500	500	$\frac{m}{E1}$	<b>3,21</b>
<b>1059579</b>	20x2,25 100m	1300	100	$\frac{m}{E1}$	<b>5,73</b>
<b>1093124</b>	20x2,25 500m	2000	500	$\frac{m}{E1}$	<b>5,73</b>
<b>1059581</b>	25x2,5 50m	700	50	$\frac{m}{E1}$	<b>11,89</b>
<b>1059583</b>	32x3,0 50m	400	50	$\frac{m}{E1}$	<b>16,74</b>

## Uponor MLC Rohr weiß

 <b>1013366</b>	14x2,0 200m	2600	200	$\frac{m}{E1}$	<b>3,34</b>
--	-------------	------	-----	----------------	-------------

## Uponor Uni Pipe PLUS weiß vorgedämmt S4 WLS 040

 <b>1091709</b>	16x2,0 red 100m	800	100	$\frac{m}{E1}$	<b>5,73</b>
<b>1063553</b>	16x2,0 blue 100m	800	100	$\frac{m}{E1}$	<b>5,73</b>
<b>1091710</b>	20x2,25 red 100m	800	100	$\frac{m}{E1}$	<b>7,64</b>
<b>1063555</b>	20x2,25 blue 100m	800	100	$\frac{m}{E1}$	<b>7,64</b>
<b>1091711</b>	25x2,5 red 50m	400	50	$\frac{m}{E1}$	<b>18,81</b>
<b>1063946</b>	25x2,5 blue 50m	400	50	$\frac{m}{E1}$	<b>18,81</b>
<b>1091712</b>	32x3,0 red 50m	350	50	$\frac{m}{E1}$	<b>25,87</b>
<b>1091716</b>	32x3,0 blue 50m	350	50	$\frac{m}{E1}$	<b>25,87</b>

Art-Nr.	Dimension	LE	VE	ME RG	Preis/ME
 <b>1063556</b>	16x2,0 blue 75m	600	75	$\frac{m}{E1}$	<b>6,01</b>
<b>1063557</b>	20x2,25 blue 75m	600	75	$\frac{m}{E1}$	<b>7,43</b>
<b>1063558</b>	25x2,5 blue 50m	400	50	$\frac{m}{E1}$	<b>17,58</b>

## Uponor Uni Pipe PLUS weiß vorgedämmt S6 WLS 035

## Uponor Uni Pipe PLUS weiß vorgedämmt S10 WLS 035

 <b>1062181</b>	16x2,0 blue 75m	450	75	$\frac{m}{E1}$	<b>6,61</b>
<b>1062182</b>	20x2,25 blue 75m	525	75	$\frac{m}{E1}$	<b>8,56</b>
<b>1062183</b>	25x2,5 blue 50m	350	50	$\frac{m}{E1}$	<b>18,95</b>

## Uponor Uni Pipe PLUS weiß vorgedämmt DHS9

 <b>1063559</b>	16x2,0 blue 75m	525	75	$\frac{m}{E1}$	<b>7,35</b>
<b>1063560</b>	20x2,25 blue 75m	525	75	$\frac{m}{E1}$	<b>9,25</b>

## Uponor Uni Pipe PLUS weiß vorgedämmt DHS26

 <b>1063561</b>	16x2,0 blue 25m	200	25	$\frac{m}{E1}$	<b>12,93</b>
<b>1063562</b>	20x2,25 blue 25m	200	25	$\frac{m}{E1}$	<b>14,86</b>

## Uponor Uni Pipe PLUS weiß im Schutzrohr

 <b>1063061</b>	16x2,0 - 25/20 red 75m	1350	75	$\frac{m}{E1}$	<b>5,87</b>
<b>1063059</b>	16x2,0 - 25/20 blue 75m	1350	75	$\frac{m}{E1}$	<b>5,87</b>
<b>1063062</b>	20x2,25 - 28/23 red 75m	900	75	$\frac{m}{E1}$	<b>9,07</b>
<b>1063060</b>	20x2,25 - 28/23 blue 75m	900	75	$\frac{m}{E1}$	<b>9,07</b>

## Uponor Teck Schutzrohr black

 <b>1012860</b>	25/20 50m	2500	50	$\frac{m}{EZ}$	<b>1,91</b>
<b>1012864</b>	28/23 50m	2000	50	$\frac{m}{EZ}$	<b>1,98</b>
<b>1012869</b>	35/29 50m	1400	50	$\frac{m}{EZ}$	<b>3,41</b>
<b>1012872</b>	43/36 25m	600	25	$\frac{m}{EZ}$	<b>5,01</b>

## Uponor Teck Schutzrohr blue

 <b>1012859</b>	25/20 50m	2500	50	$\frac{m}{EZ}$	<b>1,91</b>
<b>1012863</b>	28/23 50m	2000	50	$\frac{m}{EZ}$	<b>1,98</b>
<b>1012867</b>	35/29 50m	1400	50	$\frac{m}{EZ}$	<b>3,41</b>

## Uponor Teck Schutzrohr red

 <b>1012858</b>	25/20 50m	2500	50	$\frac{m}{EZ}$	<b>1,91</b>
<b>1012862</b>	28/23 50m	2000	50	$\frac{m}{EZ}$	<b>1,98</b>
<b>1012866</b>	35/29 50m	1400	50	$\frac{m}{EZ}$	<b>3,41</b>

# Uponor S-Press PLUS PPSU

Art-Nr.	Dimension	LE	VE	ME	Preis/ME
<b>Uponor S-Press PLUS Winkel PPSU</b>					
 1039929	16-16	80	20	St. E1	7,46
1039930	20-20	80	10	St. E1	9,74
1039931	25-25	80	10	St. E1	17,59
1039932	32-32	20	5	St. E1	24,21

<b>Uponor S-Press Verbund Winkel PPSU</b>					
 1046386	40-40	960	5	St. E1	49,57
1046387	50-50	576	3	St. E1	63,86
1032877	63-63	210	1	St. E1	118,17
1032878	75-75	210	1	St. E1	181,51

<b>Uponor S-Press Verbund Winkel 45° PPSU</b>					
 1046388	40-40	960	5	St. E1	49,54
1046389	50-50	576	3	St. E1	67,96
1032879	63-63	192	1	St. E1	124,66
1032880	75-75	192	1	St. E1	169,59

<b>Uponor S-Press PLUS Kupplung PPSU</b>					
 1039933	16-16	80	20	St. E1	6,03
1039934	20-20	80	10	St. E1	8,24
1039935	25-25	80	10	St. E1	12,21
1039936	32-32	80	10	St. E1	17,94

<b>Uponor S-Press Verbund Kupplung PPSU</b>					
 1046401	40-40	960	5	St. E1	34,67
1046402	50-50	576	3	St. E1	45,94
1032881	63-63	384	1	St. E1	86,14
1032882	75-75	384	1	St. E1	139,37

<b>Uponor S-Press PLUS Kupplung reduziert PPSU</b>					
 1039937	20-16	80	20	St. E1	8,40
1039938	25-16	80	10	St. E1	11,39
1039939	25-20	80	10	St. E1	11,39
1039940	32-25	80	10	St. E1	18,35

<b>Uponor S-Press Kupplung reduziert PPSU</b>					
 1039941	40-25	960	5	St. E1	32,38
1039942	40-32	960	5	St. E1	32,38
1039943	50-32	1152	3	St. E1	42,19
1046406	50-40	576	3	St. E1	46,39
1032883	63-40	384	1	St. E1	79,99
1032884	63-50	384	1	St. E1	81,69
1032885	75-50	384	1	St. E1	117,54
1032886	75-63	384	1	St. E1	129,99

Art-Nr.	Dimension	LE	VE	ME	Preis/ME
<b>Uponor S-Press PLUS T-Stück PPSU</b>					
 1039944	16-16-16	80	10	St. E1	11,67
1039945	20-20-20	80	10	St. E1	16,66
1039946	25-25-25	20	5	St. E1	19,99
1039947	32-32-32	20	5	St. E1	32,82

<b>Uponor S-Press Verbund T-Stück PPSU</b>					
 1046390	40-40-40	720	5	St. E1	71,44
1046391	50-50-50	288	3	St. E1	84,49
1032887	63-63-63	150	1	St. E1	150,30
1032888	75-75-75	150	1	St. E1	236,88

<b>Uponor S-Press PLUS T-Stück reduziert PPSU</b>					
 1039948	16-20-16	80	10	St. E1	16,66
1039949	20-16-16	80	10	St. E1	16,66
1039950	20-16-20	80	10	St. E1	16,66
1039951	20-20-16	80	10	St. E1	16,66
1039952	20-25-20	80	10	St. E1	21,80
1039953	25-16-16	80	10	St. E1	21,80
1039954	25-16-20	80	10	St. E1	21,80
1039955	25-16-25	80	10	St. E1	21,80
1039956	25-20-20	80	10	St. E1	21,80
1039957	25-20-25	80	10	St. E1	21,80
1039958	32-16-32	20	5	St. E1	35,25
1039959	32-20-32	20	5	St. E1	35,25
1039960	32-25-25	20	5	St. E1	35,25
1039961	32-25-32	20	5	St. E1	35,25

<b>Uponor S-Press T-Stück reduziert PPSU</b>					
 1039962	40-20-40	960	5	St. E1	63,76
1039963	40-25-32	960	5	St. E1	63,76
1039964	40-25-40	720	5	St. E1	63,76
1039965	40-32-32	960	5	St. E1	63,76
1039966	40-32-40	720	5	St. E1	63,76
1039967	50-25-40	432	3	St. E1	74,06
1039968	50-25-50	432	3	St. E1	74,06
1039969	50-32-50	432	3	St. E1	74,06

<b>Uponor S-Press Verbund T-Stück reduziert PPSU</b>					
 1046400	50-40-50	288	3	St. E1	81,55
1032889	63-25-63	150	1	St. E1	136,60
1032890	63-32-63	150	1	St. E1	141,06
1032891	63-40-63	150	1	St. E1	141,06
1032892	75-32-75	150	1	St. E1	178,41
1032893	75-40-75	150	1	St. E1	206,15
1032894	75-50-75	150	1	St. E1	206,15

# Uponor S-Press PLUS

Art-Nr.	Dimension	LE	VE	ME RG	Preis/ME
---------	-----------	----	----	----------	----------

## Uponor S-Press Übergangsnippel

 <b>1014513</b>	14-R $\frac{1}{2}$ "MT	80	20	St. E1	<b>10,86</b>
--	------------------------	----	----	-----------	--------------

## Uponor S-Press Übergangsmuffe

 <b>1014515</b>	14-Rp $\frac{1}{2}$ "FT	80	20	St. E1	<b>14,42</b>
--	-------------------------	----	----	-----------	--------------

## Uponor S-Press Kupplung

 <b>1015154</b>	14-14	80	10	St. D1	<b>11,95</b>
--	-------	----	----	-----------	--------------

## Uponor S-Press Kupplung reduziert

 <b>1015162</b>	16-14	80	20	St. E1	<b>11,52</b>
--	-------	----	----	-----------	--------------

## Uponor S-Press T-Stück

 <b>1014886</b>	14-14-14	80	10	St. E1	<b>19,01</b>
--	----------	----	----	-----------	--------------

## Uponor S-Press T-Stück reduziert

 <b>1014888</b>	14-16-14	80	10	St. E1	<b>25,34</b>
<b>1014912</b>	16-14-14	80	10	St. E1	<b>25,34</b>
<b>1014915</b>	16-14-16	80	10	St. E1	<b>25,34</b>

## Uponor S-Press Übergang auf Kupfer

 <b>1014511</b>	14-15CU	80	10	St. E1	<b>28,16</b>
--	---------	----	----	-----------	--------------

## Uponor Smart Aqua Wandscheibe S-Press

 <b>1015437</b>	14-Rp $\frac{1}{2}$ "FT	40	10	St. E1	<b>22,97</b>
--	-------------------------	----	----	-----------	--------------

## Uponor Smart Radi Anschlusswinkel S-Press

 <b>1015615</b>	14-15CU l=350mm	640	20	St. E2	<b>24,26</b>
--	-----------------	-----	----	-----------	--------------

Art-Nr.	Dimension	LE	VE	ME RG	Preis/ME
---------	-----------	----	----	----------	----------

## Uponor S-Press PLUS Übergangsnippel

 <b>1070502</b>	16-R $\frac{1}{2}$ "MT	80	20	St. E1	<b>9,44</b>
<b>1070503</b>	16-R $\frac{3}{4}$ "MT	120	15	St. E1	<b>12,53</b>
<b>1070504</b>	20-R $\frac{1}{2}$ "MT	80	20	St. E1	<b>14,27</b>
<b>1070505</b>	20-R $\frac{3}{4}$ "MT	80	10	St. E1	<b>14,27</b>
<b>1070506</b>	20-R1"MT	80	10	St. E1	<b>20,09</b>
<b>1070507</b>	25-R $\frac{3}{4}$ "MT	80	10	St. E1	<b>19,40</b>
<b>1070508</b>	25-R1"MT	40	5	St. E1	<b>22,92</b>
<b>1070509</b>	32-R1"MT	40	5	St. E1	<b>25,23</b>
<b>1070510</b>	32-R1 $\frac{1}{4}$ "MT	20	5	St. E1	<b>32,70</b>

## Uponor S-Press Übergangsnippel

 <b>1046901</b>	40-R1 $\frac{1}{4}$ "MT	960	5	St. E1	<b>40,86</b>
<b>1046902</b>	40-R1 $\frac{1}{2}$ "MT	960	5	St. E1	<b>45,18</b>
<b>1046905</b>	50-R1 $\frac{1}{2}$ "MT	1152	3	St. E1	<b>67,79</b>
<b>1046906</b>	50-R2"MT	576	3	St. E1	<b>87,11</b>
<b>1032895</b>	63-R2"MT	336	1	St. E1	<b>123,68</b>
<b>1032896</b>	75-R2 $\frac{1}{2}$ "MT	336	1	St. E1	<b>163,05</b>

## Uponor S-Press PLUS Übergangsmuffe

 <b>1070515</b>	16-Rp $\frac{1}{2}$ "FT	80	20	St. E1	<b>11,18</b>
<b>1070516</b>	20-Rp $\frac{1}{2}$ "FT	120	15	St. E1	<b>16,76</b>
<b>1070517</b>	20-Rp $\frac{3}{4}$ "FT	80	10	St. E1	<b>16,76</b>
<b>1070518</b>	20-Rp1"FT	80	20	St. E1	<b>23,25</b>
<b>1070519</b>	25-Rp $\frac{3}{4}$ "FT	40	5	St. E1	<b>22,56</b>
<b>1070520</b>	25-Rp1"FT	40	5	St. E1	<b>23,75</b>
<b>1070521</b>	32-Rp1"FT	40	5	St. E1	<b>27,61</b>
<b>1070522</b>	32-Rp1 $\frac{1}{4}$ "FT	20	5	St. E1	<b>34,07</b>

## Uponor S-Press Übergangsmuffe

 <b>1046903</b>	40-Rp1 $\frac{1}{4}$ "FT	960	5	St. E1	<b>42,51</b>
<b>1046904</b>	40-Rp1 $\frac{1}{2}$ "FT	960	5	St. E1	<b>42,96</b>
<b>1046907</b>	50-Rp1 $\frac{1}{2}$ "FT	1152	3	St. E1	<b>103,59</b>



# Uponor S-Press PLUS

Art-Nr.	Dimension	LE	VE	ME RG	Preis/ME
<b>Uponor S-Press PLUS Winkel</b>					
 <b>1070523</b>	16-16	80	20	St. E1	<b>11,22</b>
<b>1070524</b>	20-20	80	10	St. E1	<b>15,09</b>
<b>1070525</b>	25-25	40	5	St. E1	<b>22,00</b>
<b>1070526</b>	32-32	20	5	St. E1	<b>33,35</b>

## Uponor S-Press Winkel

 <b>1046908</b>	40-40	600	5	St. E1	<b>50,15</b>
<b>1046911</b>	50-50	240	3	St. E1	<b>66,54</b>

## Uponor S-Press PLUS Bogen

 <b>1070527</b>	16-16	80	10	St. E1	<b>16,05</b>
<b>1070528</b>	20-20	80	10	St. E1	<b>18,96</b>
<b>1070529</b>	25-25	40	5	St. E1	<b>27,66</b>
<b>1070530</b>	32-32	20	5	St. E1	<b>35,00</b>

## Uponor S-Press PLUS Winkelnippel

 <b>1070532</b>	16-R $\frac{1}{2}$ "MT	80	20	St. E1	<b>13,49</b>
<b>1070533</b>	20-R $\frac{1}{2}$ "MT	80	10	St. E1	<b>23,40</b>
<b>1070534</b>	20-R $\frac{3}{4}$ "MT	80	10	St. E1	<b>30,21</b>
<b>1070535</b>	25-R $\frac{3}{4}$ "MT	40	5	St. E1	<b>29,28</b>
<b>1070536</b>	25-R1"MT	40	5	St. E1	<b>35,89</b>
<b>1070537</b>	32-R1"MT	20	5	St. E1	<b>44,22</b>

## Uponor S-Press Winkelnippel

 <b>1046909</b>	40-R1 $\frac{1}{4}$ "MT	500	5	St. E1	<b>75,58</b>
--	-------------------------	-----	---	-----------	--------------

Art-Nr.	Dimension	LE	VE	ME RG	Preis/ME
<b>Uponor S-Press PLUS Winkelmuße</b>					
 <b>1070539</b>	16-Rp $\frac{1}{2}$ "FT	80	10	St. E1	<b>15,71</b>
<b>1070540</b>	20-Rp $\frac{1}{2}$ "FT	80	10	St. E1	<b>26,57</b>
<b>1070541</b>	20-Rp $\frac{3}{4}$ "FT	40	10	St. E1	<b>27,77</b>
<b>1070542</b>	25-Rp $\frac{3}{4}$ "FT	20	5	St. E1	<b>34,33</b>
<b>1070543</b>	25-Rp1"FT	20	5	St. E1	<b>42,36</b>
<b>1070544</b>	32-Rp1"FT	20	5	St. E1	<b>54,08</b>

## Uponor S-Press Winkelmuße

 <b>1046910</b>	40-Rp1 $\frac{1}{2}$ "FT	500	5	St. E1	<b>76,74</b>
<b>1046912</b>	50-Rp1 $\frac{1}{2}$ "FT	300	3	St. E1	<b>89,92</b>

## Uponor S-Press PLUS Winkel 45°

 <b>1070545</b>	25-25	20	5	St. E1	<b>33,35</b>
<b>1070546</b>	32-32	20	5	St. E1	<b>56,41</b>

## Uponor S-Press Winkel 45°

 <b>1046913</b>	40-40	500	5	St. E1	<b>58,15</b>
<b>1046914</b>	50-50	300	3	St. E1	<b>80,00</b>

## Uponor S-Press PLUS Kupplung

 <b>1070547</b>	16-16	80	20	St. D1	<b>9,59</b>
<b>1070548</b>	20-20	80	10	St. E1	<b>11,96</b>
<b>1070549</b>	25-25	80	10	St. E1	<b>18,28</b>
<b>1070550</b>	32-32	40	5	St. E1	<b>22,47</b>

## Uponor S-Press PLUS Schiebekupplung

 <b>1118706</b>	16-16	80	10	St. E1	<b>59,36</b>
<b>1118707</b>	20-20	80	10	St. E1	<b>69,28</b>
<b>1118708</b>	25-25	40	5	St. E1	<b>82,68</b>
<b>1118709</b>	32-32	20	5	St. E1	<b>89,74</b>
<b>1118710</b>	40-40	12	3	St. E1	<b>148,62</b>

# Uponor S-Press PLUS

Art-Nr.	Dimension	LE	VE	ME RG	Preis/ME
---------	-----------	----	----	----------	----------

## Uponor S-Press Kupplung

 <b>1046932</b>	40-40	960	5	St. E1	<b>39,19</b>
<b>1046935</b>	50-50	576	3	St. E1	<b>50,78</b>

## Uponor S-Press PLUS Kupplung reduziert

 <b>1070552</b>	20-16	80	20	St. E1	<b>11,76</b>
<b>1070553</b>	25-16	80	10	St. E1	<b>18,00</b>
<b>1070554</b>	25-20	80	10	St. E1	<b>18,23</b>
<b>1070555</b>	32-20	80	10	St. E1	<b>22,75</b>
<b>1070556</b>	32-25	80	10	St. E1	<b>23,99</b>

## Uponor S-Press Kupplung reduziert

 <b>1046930</b>	40-25	960	5	St. E1	<b>37,33</b>
<b>1046931</b>	40-32	960	5	St. E1	<b>37,78</b>
<b>1046933</b>	50-32	1152	3	St. E1	<b>44,26</b>
<b>1046934</b>	50-40	576	3	St. E1	<b>45,08</b>

## Uponor S-Press PLUS T-Stück

 <b>1070560</b>	16-16-16	80	10	St. E1	<b>14,94</b>
<b>1070561</b>	20-20-20	80	10	St. E1	<b>20,12</b>
<b>1070562</b>	25-25-25	20	5	St. E1	<b>29,28</b>
<b>1070563</b>	32-32-32	20	5	St. E1	<b>48,95</b>

## Uponor S-Press T-Stück

 <b>1046921</b>	40-40-40	400	5	St. E1	<b>68,51</b>
<b>1046928</b>	50-50-50	300	3	St. E1	<b>90,04</b>

## Uponor S-Press PLUS T-Stück reduziert

 <b>1070566</b>	16-20-16	80	10	St. E1	<b>21,24</b>
<b>1070567</b>	20-16-16	40	10	St. E1	<b>21,24</b>
<b>1070568</b>	20-16-20	80	20	St. E1	<b>20,55</b>
<b>1070569</b>	20-20-16	80	20	St. E1	<b>20,55</b>
<b>1070570</b>	20-25-16	40	10	St. E1	<b>28,76</b>
<b>1070571</b>	20-25-20	40	10	St. E1	<b>28,76</b>
<b>1070572</b>	25-16-16	40	5	St. E1	<b>28,76</b>
<b>1070573</b>	25-16-20	40	5	St. E1	<b>28,76</b>
<b>1070574</b>	25-16-25	20	5	St. E1	<b>28,76</b>
<b>1070575</b>	25-20-16	40	5	St. E1	<b>28,76</b>
<b>1070576</b>	25-20-20	40	5	St. E1	<b>28,76</b>
<b>1070577</b>	25-20-25	20	5	St. E1	<b>28,76</b>
<b>1070578</b>	25-25-16	20	5	St. E1	<b>28,76</b>
<b>1070579</b>	25-32-25	20	5	St. E1	<b>54,74</b>
<b>1070580</b>	32-16-32	20	5	St. E1	<b>54,74</b>
<b>1070581</b>	32-20-32	20	5	St. E1	<b>54,74</b>
<b>1070582</b>	32-25-25	20	5	St. E1	<b>54,74</b>
<b>1070583</b>	32-25-32	20	5	St. E1	<b>54,74</b>

Art-Nr.	Dimension	LE	VE	ME RG	Preis/ME
---------	-----------	----	----	----------	----------

## Uponor S-Press T-Stück reduziert

 <b>1046916</b>	40-20-40	400	5	St. E1	<b>66,81</b>
<b>1046917</b>	40-25-32	500	5	St. E1	<b>59,55</b>
<b>1046918</b>	40-25-40	400	5	St. E1	<b>66,81</b>
<b>1046919</b>	40-32-32	400	5	St. E1	<b>61,28</b>
<b>1046920</b>	40-32-40	400	5	St. E1	<b>66,81</b>
<b>1046924</b>	50-25-40	300	3	St. E1	<b>89,43</b>
<b>1046925</b>	50-25-50	240	3	St. E1	<b>94,56</b>
<b>1046926</b>	50-32-50	300	3	St. E1	<b>94,57</b>
<b>1046927</b>	50-40-50	300	3	St. E1	<b>95,90</b>

## Uponor S-Press PLUS T-Stück m. Aussengew

 <b>1070592</b>	16-R $\frac{1}{2}$ "MT-16	40	10	St. E1	<b>33,86</b>
<b>1070593</b>	25-R $\frac{3}{4}$ "MT-25	20	5	St. E1	<b>43,54</b>
<b>1070594</b>	32-R $\frac{3}{4}$ "MT-32	20	5	St. E1	<b>53,77</b>

## Uponor S-Press PLUS T-Stück m. Innengew.

 <b>1070595</b>	16-Rp $\frac{1}{2}$ "FT-16	40	10	St. E1	<b>29,41</b>
<b>1070596</b>	20-Rp $\frac{1}{2}$ "FT-20	60	15	St. E1	<b>33,24</b>
<b>1070597</b>	20-Rp $\frac{3}{4}$ "FT-20	40	10	St. E1	<b>35,38</b>
<b>1070598</b>	25-Rp $\frac{1}{2}$ "FT-25	20	5	St. E1	<b>37,59</b>
<b>1070599</b>	25-Rp $\frac{3}{4}$ "FT-25	20	5	St. E1	<b>40,87</b>
<b>1070600</b>	32-Rp $\frac{1}{2}$ "FT-32	20	5	St. E1	<b>53,86</b>
<b>1070601</b>	32-Rp $\frac{3}{4}$ "FT-32	20	5	St. E1	<b>53,86</b>

## Uponor S-Press T-Stück mit Innengewinde

 <b>1046922</b>	40-Rp $\frac{1}{2}$ "FT-40	500	5	St. E1	<b>62,66</b>
<b>1046923</b>	40-Rp $\frac{3}{4}$ "FT-40	400	5	St. E1	<b>62,66</b>
<b>1046929</b>	50-Rp1"FT-50	240	3	St. E1	<b>104,22</b>

# Uponor S-Press PLUS

Art-Nr.	Dimension	LE	VE	ME RG	Preis/ME
 <b>1070602</b>	16-G $\frac{1}{2}$ "SN	30	1	St. E1	<b>21,53</b>
<b>1070603</b>	16-G $\frac{3}{4}$ "SN	20	1	St. E1	<b>25,92</b>
<b>1070604</b>	20-G $\frac{1}{2}$ "SN	20	1	St. E1	<b>23,64</b>
<b>1070605</b>	20-G $\frac{3}{4}$ "SN	20	1	St. E1	<b>29,04</b>
<b>1070606</b>	25-G $\frac{3}{4}$ "SN	15	1	St. E1	<b>32,94</b>
<b>1070607</b>	25-G1"SN	15	1	St. E1	<b>32,94</b>
<b>1070608</b>	25-G1 $\frac{1}{4}$ „SN	10	1	St. E1	<b>37,83</b>
<b>1070609</b>	32-G1"SN	10	1	St. E1	<b>44,17</b>
<b>1070610</b>	32-G1 $\frac{1}{4}$ "SN	10	1	St. E1	<b>38,63</b>

## Uponor S-Press Verschraubung IG

 <b>1060094</b>	40-G1 $\frac{1}{4}$ "SN	960	5	St. E1	<b>82,52</b>
<b>1046937</b>	40-G1 $\frac{1}{2}$ "SN	960	5	St. E1	<b>64,10</b>
<b>1060095</b>	50-G1 $\frac{1}{2}$ "SN	1152	3	St. E1	<b>87,11</b>
<b>1046938</b>	50-G1 $\frac{3}{4}$ "SN	1152	3	St. E1	<b>67,44</b>
<b>1046939</b>	50-G2"SN	576	3	St. E1	<b>73,45</b>

## Uponor S-Press PLUS Winkelverschraubung IG

 <b>1070611</b>	16-G $\frac{3}{8}$ "SN	20	1	St. E1	<b>23,60</b>
<b>1070612</b>	16-G $\frac{1}{2}$ "SN	20	1	St. E1	<b>23,70</b>
<b>NEU</b> <b>1105818</b>	16-G $\frac{3}{4}$ "SN	10	1	St. E1	<b>25,52</b>
<b>1070613</b>	20-G $\frac{1}{2}$ "SN	20	1	St. E1	<b>28,41</b>
<b>NEU</b> <b>1105819</b>	20-G $\frac{3}{4}$ "SN	10	1	St. E1	<b>26,68</b>
<b>1070614</b>	25-G $\frac{3}{4}$ "SN	10	1	St. E1	<b>30,70</b>

Art-Nr.	Dimension	LE	VE	ME RG	Preis/ME
 <b>1070638</b>	16-Rp $\frac{3}{8}$ "FT	40	10	St. E1	<b>22,49</b>
<b>1070639</b>	16-Rp $\frac{1}{2}$ "FT	40	10	St. E1	<b>18,46</b>
<b>1070640</b>	20-Rp $\frac{1}{2}$ "FT	40	10	St. E1	<b>22,49</b>
<b>1070641</b>	20-Rp $\frac{3}{4}$ "FT	20	5	St. E1	<b>24,48</b>
<b>1070642</b>	25-Rp $\frac{3}{4}$ "FT	20	5	St. E1	<b>30,54</b>

## Uponor S-Press PLUS Wandscheibe L

 <b>1070644</b>	16-Rp $\frac{1}{2}$ "FT	40	10	St. E1	<b>25,26</b>
<b>1070645</b>	20-Rp $\frac{1}{2}$ "FT	40	10	St. E1	<b>29,12</b>

## Uponor S-Press PLUS Wandscheibe XL

 <b>1070646</b>	16-Rp $\frac{1}{2}$ "FT	40	10	St. E1	<b>30,84</b>
<b>1070647</b>	20-Rp $\frac{1}{2}$ "FT	40	10	St. E1	<b>32,46</b>

## Uponor S-Press PLUS Schallset 2 Wandscheiben

 <b>NEU</b> <b>1121193</b>	16-20	192	1	Set E1	<b>34,83</b>
---	-------	-----	---	-----------	--------------

## Uponor S-Press PLUS U-Wandscheibe

 <b>1070629</b>	16-Rp $\frac{1}{2}$ "FT-16	20	5	St. E1	<b>45,91</b>
<b>1070630</b>	20-Rp $\frac{1}{2}$ "FT-20	960	5	St. E1	<b>57,12</b>
<b>1070631</b>	20-Rp $\frac{1}{2}$ "FT-16	960	5	St. E1	<b>64,16</b>
<b>1070632</b>	16-Rp $\frac{1}{2}$ "FT-20	960	5	St. E1	<b>64,16</b>
<b>1070633</b>	25-Rp $\frac{1}{2}$ "FT-25	576	3	St. E1	<b>94,74</b>
<b>1070634</b>	25-Rp $\frac{1}{2}$ "FT-20	576	3	St. E1	<b>100,57</b>
<b>1070635</b>	20-Rp $\frac{1}{2}$ "FT-25	576	3	St. E1	<b>109,03</b>

## Uponor S-Press PLUS Schallset U-Wandscheibe

 <b>NEU</b> <b>1121194</b>	16-20	384	1	St. E1	<b>20,64</b>
---	-------	-----	---	-----------	--------------

## Uponor S-Press PLUS U-Armaturenanschluss

 <b>1070636</b>	16-16-R $\frac{1}{2}$ "MT	960	5	St. E1	<b>83,85</b>
<b>1070637</b>	20-20-R $\frac{3}{4}$ "MT	960	5	St. E1	<b>83,85</b>

## Uponor S-Press PLUS Doppel-Wands. 90° L long

 <b>1070648</b>	16-Rp $\frac{1}{2}$ "FT-16	40	10	St. E1	<b>41,96</b>
<b>1070649</b>	20-Rp $\frac{1}{2}$ "FT-20	40	10	St. E1	<b>49,07</b>

# Uponor S-Press PLUS

Art-Nr.	Dimension	LE	VE	ME RG	Preis/ME
---------	-----------	----	----	----------	----------

## Uponor S-Press PLUS Anschlusswink. flach

 <b>1070657</b>	16-Rp½"FT	10	1	St. E1	<b>30,45</b>
--	-----------	----	---	-----------	--------------

## Uponor S-Press PLUS SK-T-Stück Geberit

 <b>1070659</b>	16-G½"FT-16	10	1	St. E1	<b>36,25</b>
--	-------------	----	---	-----------	--------------

## Uponor S-Press PLUS SK-Winkelverschraub. Geberit

 <b>1070658</b>	16-½"FT	80	20	St. E1	<b>19,31</b>
--	---------	----	----	-----------	--------------

## Uponor Smart Aqua SK-Verschraubung Geberit

 <b>1058097</b>	16-½"FT	25	1	St. E1	<b>11,62</b>
--	---------	----	---	-----------	--------------

## Uponor S-Press PLUS Endstück

 <b>1070621</b>	16	160	40	St. E1	<b>9,50</b>
<b>1070622</b>	20	7680	20	St. E1	<b>16,10</b>
<b>1070623</b>	25	3840	10	St. E1	<b>18,53</b>
<b>1070624</b>	32	1920	5	St. E1	<b>23,51</b>

## Uponor MLC Abdrückstopfen

 <b>1013754</b>	14	7680	20	St. E1	<b>21,64</b>
<b>1013756</b>	16	7680	20	St. E1	<b>21,64</b>
<b>1013760</b>	20	3840	20	St. E1	<b>23,32</b>
<b>1013762</b>	25	3840	10	St. E1	<b>25,53</b>
<b>1013764</b>	32	3840	10	St. E1	<b>39,19</b>
<b>1013765</b>	40	960	5	St. E1	<b>50,15</b>

## Uponor MLC O-Ring für Abdrückstopfen

 <b>1013798</b>	14	10000	10	St. E1	<b>0,53</b>
<b>1013799</b>	16	1000	10	St. E1	<b>0,68</b>
<b>1013801</b>	20	1000	10	St. E1	<b>0,95</b>
<b>1013802</b>	25	500	10	St. E1	<b>1,07</b>
<b>1013803</b>	32	500	10	St. E1	<b>1,07</b>
<b>1013804</b>	40	10000	10	St. E1	<b>1,45</b>

Art-Nr.	Dimension	LE	VE	ME RG	Preis/ME
---------	-----------	----	----	----------	----------

## Uponor S-Press PLUS Montageeinheit mit Schallset

 <b>NEU 1070666</b>	16-Rp½"FT c/c150mm	150	5	St. E1	<b>70,38</b>
--	--------------------	-----	---	-----------	--------------

## Uponor S-Press PLUS Montageeinheit

 <b>1070661</b>	16-Rp½"FT c/c80mm	5	1	St. E1	<b>53,25</b>
<b>1070662</b>	16-Rp½"FT c/c150mm	380	5	St. E1	<b>53,25</b>

## Uponor S-Press PLUS Montageeinheit Gemini

 <b>1070663</b>	16-Rp½"FT c/c120mm	720	5	St. E1	<b>53,59</b>
<b>1070664</b>	16-Rp½"FT c/c150mm	720	5	St. E1	<b>53,59</b>

## Uponor S-Press PLUS Mauerdurchführung

 <b>1070652</b>	16-G½"FT	5	1	St. E1	<b>33,36</b>
--	----------	---	---	-----------	--------------

## Uponor S-Press PLUS Wanddurchführung Eck LWC

 <b>1070653</b>	16-Rp½"FT l=25	5	1	St. E1	<b>59,06</b>
<b>1070654</b>	16-Rp½"FT l=35	5	1	St. E1	<b>60,31</b>

## Uponor S-Press PLUS U-Wanddurchführ. Eck LWC

 <b>1070655</b>	16-Rp½"FT-16 l=25	5	1	St. E1	<b>100,91</b>
<b>1070656</b>	16-Rp½"FT-16 l=35	5	1	St. E1	<b>103,24</b>

## Uponor Smart Aqua Dichtflansch LWC

 <b>1084151</b>		50	10	St. E1	<b>4,14</b>
--	--	----	----	-----------	-------------

Die Uponor Wanddurchführungen sind auf Anfrage für Projektierungen auch in 20 mm erhältlich. Der Uponor S-Press Anschluss kann auch mit der RTM-Technologie oder als Q&E-Verbindung in 16 und 20 mm geliefert werden. Sonderlängen der Einbautiefe sind von 35 mm bis 65 mm in mm-Schritten möglich.

 Lieferung solange Vorrat reicht. Artikel läuft im Laufe des Jahres aus.

# Uponor S-Press PLUS

Art-Nr.	Dimension	LE	VE	ME RG	Preis/ME
---------	-----------	----	----	----------	----------

## Uponor S-Press PLUS Montageplatte

 <b>NEU</b> 1121197	80/150mm	5	1	St. E1	10,84
--	----------	---	---	-----------	-------

## Uponor S-Press PLUS Montagewinkel

 <b>NEU</b> 1121196	100mm	5	1	St. E1	12,26
<b>NEU</b> 1121195	80/150mm	5	1	St. E1	13,55

## Uponor Smart Aqua Montagewinkel Gemini

 1059824	120mm	5	1	St. E1	7,60
1059825	150mm	5	1	St. E1	8,05

## Übergangsnippel

### Uponor S-Press Übergangskupplung auf Polyfix

 1015168	16-16	80	20	St. U2	18,32
1015192	20-20	3840	10	St. U2	19,16
1015210	25-26	1920	5	St. U2	33,00
1015224	32-32	1920	5	St. U2	33,34

### Uponor S-Press Übergangskupplung auf Rapex

 1015167	16-16	80	20	St. U2	18,32
1015190	20-20	3840	10	St. U2	19,16
1015208	25-26	1920	5	St. U2	26,91
1015222	32-32	1920	5	St. U2	31,23

### Uponor S-Press Kupplung auf Edelstahl/CU V

 1090678	16-15CU-SST	10	1	St. E1	23,10
1090679	20-22CU-SST	5	1	St. E1	33,62
1090680	25-22CU-SST	5	1	St. E1	35,82
1090681	32-28CU-SST	5	1	St. E1	50,76

Art-Nr.	Dimension	LE	VE	ME RG	Preis/ME
---------	-----------	----	----	----------	----------

## Uponor Smart Aqua Einzelmontagewinkel

 1057843		5	1	St. E1	8,59
---	--	---	---	-----------	------

## Uponor Smart Aqua Montageschiene

 1057844	2m	10	1	St. E1	43,16
---	----	----	---	-----------	-------

## Uponor Smart Aqua Biegezange für Montageschiene

 1015424	2m	100	1	St. NET	150,14
---	----	-----	---	------------	--------

## Uponor Smart Aqua 10 Bolzen+20 Schrauben

 1057847		-	1	Set E1	14,43
---	--	---	---	-----------	-------

### Uponor S-Press Kupplung auf Edelstahl/CU M

 1090682	16-15CU-SST	10	1	St. E1	23,10
1090683	20-22CU-SST	5	1	St. E1	33,62
1090684	25-22CU-SST	5	1	St. E1	35,82
1090685	32-28CU-SST	5	1	St. E1	50,76

### Uponor S-Press PLUS Übergang auf Kupfer

 1070705	16-10CU	80	20	St. E1	15,27
1070706	16-12CU	80	20	St. E1	15,33
1070615	16-15CU	160	20	St. E1	15,47
1070616	20-18CU	40	10	St. E1	20,39
1070617	20-22CU	60	15	St. E1	20,94
1070618	25-22CU	20	5	St. E1	25,23
1070620	32-28CU	20	5	St. E1	38,20

### Uponor S-Press Kupplung reduziert

 1015172	18-16	80	20	St. E1	16,28
1015185	20-18	80	10	St. E1	17,87

# Uponor S-Press PLUS

Art-Nr.	Dimension	LE	VE	ME RG	Preis/ME
---------	-----------	----	----	----------	----------

Art-Nr.	Dimension	LE	VE	ME RG	Preis/ME
---------	-----------	----	----	----------	----------

## Uponor S-Press PLUS Edelstahl

### Uponor S-Press Übergangsnippel Edelstahl

 <b>OUT</b>	<b>1090686</b>	16-R $\frac{1}{2}$ "MT	10	1	St. E1	<b>40,26</b>
<b>OUT</b>	<b>1090687</b>	20-R $\frac{3}{4}$ "MT	10	1	St. E1	<b>44,68</b>
<b>OUT</b>	<b>1090688</b>	25-R $\frac{3}{4}$ "MT	5	1	St. E1	<b>62,65</b>

### Uponor S-Press Übergang auf Edelstahl SST

	<b>1089056</b>	16-15SST	10	1	St. E1	<b>19,99</b>
	<b>1089057</b>	20-22SST	10	1	St. E1	<b>28,29</b>
	<b>1089058</b>	25-22SST	5	1	St. E1	<b>28,99</b>
	<b>1089059</b>	32-28SST	5	1	St. E1	<b>43,57</b>

### Uponor S-Press Übergangsmuffe Edelstahl

 <b>OUT</b>	<b>1090689</b>	25-Rp $\frac{3}{4}$ "FT	5	1	St. E1	<b>67,08</b>
<b>OUT</b>	<b>1090690</b>	32-Rp1"FT	5	1	St. E1	<b>89,36</b>

### Uponor Smart Aqua U-Wandscheibe Edelstahl S-Press

 <b>OUT</b>	<b>1090691</b>	16-Rp $\frac{1}{2}$ "FT-16	5	1	St. E1	<b>126,72</b>
<b>OUT</b>	<b>1090692</b>	20-Rp $\frac{1}{2}$ "FT-20	5	1	St. E1	<b>134,18</b>

### Uponor Smart Aqua Wandscheibe Edelstahl S-Press

 <b>OUT</b>	<b>1090693</b>	16-Rp $\frac{1}{2}$ "FT	10	1	St. E1	<b>71,51</b>
<b>OUT</b>	<b>1090694</b>	20-Rp $\frac{1}{2}$ "FT	10	1	St. E1	<b>84,93</b>

Lieferung solange Vorrat reicht. Artikel läuft im Laufe des Jahres aus.

## NEU: Uponor S-Press PLUS Ventilprogramm

### Uponor S-Press PLUS Schrägsitzventil mit Rückflussverhinderer

 <b>NEU</b>	<b>1119315</b>	20mm	5	1	St. E1	<b>148,22</b>
<b>NEU</b>	<b>1119316</b>	25mm	5	1	St. E1	<b>186,79</b>
<b>NEU</b>	<b>1119317</b>	32mm	5	1	St. E1	<b>287,54</b>
<b>NEU</b>	<b>1119318</b>	40mm	5	1	St. E1	<b>361,59</b>

### Uponor S-Press PLUS Unterputzventil

 <b>NEU</b>	<b>1119321</b>	16mm	5	1	St. E1	<b>100,75</b>
<b>NEU</b>	<b>1119322</b>	20mm	5	1	St. E1	<b>149,64</b>
<b>NEU</b>	<b>1119323</b>	25mm	5	1	St. E1	<b>160,09</b>

### Uponor S-Press PLUS Schrägsitzventil

 <b>NEU</b>	<b>1119311</b>	20mm	5	1	St. E1	<b>118,55</b>
<b>NEU</b>	<b>1119312</b>	25mm	5	1	St. E1	<b>177,89</b>
<b>NEU</b>	<b>1119313</b>	32mm	5	1	St. E1	<b>266,77</b>
<b>NEU</b>	<b>1119314</b>	40mm	5	1	St. E1	<b>311,28</b>

### Uponor S-Press PLUS Wasserzählerbox

 <b>NEU</b>	<b>1119324</b>	G2" Coax DN $\frac{3}{4}$ "	75	1	St. E1	<b>548,38</b>
--	----------------	-----------------------------	----	---	-----------	---------------

### Uponor S-Press PLUS Zirkulationsventil

 <b>NEU</b>	<b>1119319</b>	16mm	-	1	St. E1	<b>462,47</b>
<b>NEU</b>	<b>1119320</b>	20mm	-	1	St. E1	<b>466,85</b>

# Uponor Smart ISI Installationsboxen

Art-Nr.	Dimension	LE	VE	ME	Preis/ME
---------	-----------	----	----	----	----------

## Uponor Smart ISI Waschtisch WT



<b>1061610*</b>	16-Rp $\frac{1}{2}$ "FT, c/c=80mm DN50	24	1	Set I3	Preis auf Anfrage
-----------------	---	----	---	-----------	-------------------

## Uponor Smart ISI Waschtisch WT-U



<b>1061615*</b>	16-Rp $\frac{1}{2}$ "FT, c/c=80mm DN50	24	1	Set I3	Preis auf Anfrage
-----------------	---	----	---	-----------	-------------------

## Uponor Smart ISI Spültisch ST



<b>1061611*</b>	16-Rp $\frac{1}{2}$ "FT, c/c=150mm DN50	12	1	Set I3	Preis auf Anfrage
-----------------	--	----	---	-----------	-------------------

## Uponor Smart ISI Spültisch ST-U



<b>1061616*</b>	16-Rp $\frac{1}{2}$ "FT, c/c=150mm DN50	12	1	Set I3	Preis auf Anfrage
-----------------	--	----	---	-----------	-------------------

Art-Nr.	Dimension	LE	VE	ME	Preis/ME
---------	-----------	----	----	----	----------

## Uponor Smart ISI Badarmatur BA



<b>1061612*</b>	16-Rp $\frac{1}{2}$ "FT, c/c=150mm	24	1	Set I3	Preis auf Anfrage
-----------------	---------------------------------------	----	---	-----------	-------------------

## Uponor Smart ISI Badarmatur BA-U



<b>1061617*</b>	16-Rp $\frac{1}{2}$ "FT, c/c=150mm	24	1	Set I3	Preis auf Anfrage
-----------------	---------------------------------------	----	---	-----------	-------------------

## Uponor Smart ISI Waschmaschine WM



<b>1061613*</b>	16-Rp $\frac{1}{2}$ "FT, DN50, HL400	12	1	Set I3	Preis auf Anfrage
-----------------	---	----	---	-----------	-------------------

## Uponor Smart ISI Waschmaschine WM-U



<b>1061618*</b>	16-Rp $\frac{1}{2}$ "FT, DN50, HL400	12	1	Set I3	Preis auf Anfrage
-----------------	---	----	---	-----------	-------------------

## Uponor Smart ISI Waschtischbefestigung WT







<b>1061614*</b>		50	1	Set I3	Preis auf Anfrage
-----------------	--	----	---	-----------	-------------------

Baustellenbezogene Lieferung von Uponor Smart ISI Boxen in Sonderausführungen sind möglich.





# Uponor S-Press PLUS Heizung

Art-Nr.	Dimension	LE	VE	ME RG	Preis/ME
 <b>1070689</b>	16-16-16	192	1	St. E2	<b>76,92</b>
 <b>1070690</b>	20-16-16	192	1	St. E2	<b>82,13</b>
 <b>1070691</b>	20-16-20	192	1	St. E2	<b>82,13</b>
 <b>1070692</b>	20-20-20	192	1	St. E2	<b>79,61</b>



## Uponor Smart Radi Anschlussblock

 <b>1013134</b>	16 h=215mm	240	10	St. E2	<b>43,09</b>
 <b>1007077</b>	16 h=240mm	240	10	St. E2	<b>53,94</b>







## Uponor S-Press PLUS HK-Anschlusswinkel

 <b>1070678</b>	16-15CU l=350mm	1680	20	St. E2	<b>21,87</b>
 <b>1070679</b>	16-15CU l=1000mm	400	20	St. E2	<b>40,02</b>

## Uponor S-Press PLUS HK-Anschl. T-Stück

 <b>1070681</b>	16-15CU-16 l=350mm	600	20	St. E2	<b>37,97</b>
 <b>1070682</b>	20-15CU-20 l=350mm	600	20	St. E2	<b>49,01</b>



## Uponor S-Press PLUS SL-Anschlussgarnitur

 <b>1070693</b>	16-G½"MT-16	192	1	St. E2	<b>93,19</b>
 <b>1070694</b>	16-G½"MT-20	192	1	St. E2	<b>93,19</b>
 <b>1070695</b>	16-G½"MT-0	192	1	St. E2	<b>93,19</b>
 <b>1070696</b>	20-G½"MT-16	192	1	St. E2	<b>93,19</b>
 <b>1094219</b>	0-G½"MT-16	192	1	St. E2	<b>93,19</b>
 <b>1070697</b>	20-G½"MT-20	192	1	St. E2	<b>93,19</b>

## Uponor Smart Base SL-Winkel SL

 <b>1014060</b>	15x1	25	1	Set E2	<b>59,13</b>
--	------	----	---	-----------	--------------

## Uponor S-Press PLUS HK-Montageplatte radi

 <b>1070683</b>	16-Rp½"FT c/c35mm	720	5	St. E2	<b>53,19</b>
 <b>1070684</b>	16-Rp½"FT c/c50mm	720	5	St. E2	<b>53,19</b>

## Uponor Smart Radi Anschlussrohr

 <b>1015425</b>	G½"MT-15CU l=350mm	640	20	St. E2	<b>29,77</b>
--	--------------------	-----	----	-----------	--------------

Art-Nr.	Dimension	LE	VE	ME RG	Preis/ME
---------	-----------	----	----	----------	----------

## Uponor Smart Radi Klemmverschraubung Cu

 <b>1013830</b>	15CU-¾" Euro	80	10	St. D1	<b>7,38</b>
--	--------------	----	----	-----------	-------------

## Uponor Smart Radi Anschlussnippel

 <b>1013906</b>	G¾"MT-G½"MT	80	10	St. D1	<b>6,72</b>
--	-------------	----	----	-----------	-------------

## Uponor Smart Radi Anschlussgarnitur Danfoss

 <b>1013970</b>	16-G½"MT	20	1	St. E2	<b>8,51</b>
--	----------	----	---	-----------	-------------

## Uponor Smart Radi Anschlussgarnitur Heimeier

 <b>1013978</b>	16-G½"MT	20	1	St. E2	<b>8,03</b>
--	----------	----	---	-----------	-------------

## Uponor Smart Radi Anschlussgarnitur Oventrop

 <b>1014016</b>	16-G½"MT	20	1	St. E2	<b>11,23</b>
---	----------	----	---	-----------	--------------

## Uponor Smart Radi Anschlusset

 <b>1011364</b>		100	10	St. E2	<b>14,57</b>
--	--	-----	----	-----------	--------------

## Uponor Smart Radi Rosette weiß

 <b>1011370</b>	16 white	20000	50	St. E2	<b>0,81</b>
--	----------	-------	----	-----------	-------------

## Uponor Smart Radi Stufen-Doppelrosette

 <b>1011373</b>	14-20 white double	500	50	St. D1	<b>2,91</b>
--	--------------------	-----	----	-----------	-------------

## Uponor S-Press Thermostatventil Aquastrom T plus

 <b>1013243</b>	G¾"MT	300	1	St. E1	<b>499,00</b>
--	-------	-----	---	-----------	---------------



# Uponor RS

Art-Nr.	Dimension	LE	VE	ME RG	Preis/ME
---------	-----------	----	----	----------	----------

## Uponor RS Kupplung

 <b>1029144</b>	RS2-RS2	480	1	St. E1	<b>39,13</b>
<b>1029145</b>	RS3-RS3	480	1	St. E1	<b>84,73</b>

## Uponor RS Winkel

 <b>1029138</b>	RS2-RS2	336	1	St. E1	<b>53,47</b>
<b>1029139</b>	RS3-RS3	240	1	St. E1	<b>137,61</b>

## Uponor RS Winkel 45°

 <b>1029140</b>	RS2-RS2	336	1	St. E1	<b>63,81</b>
<b>1029141</b>	RS3-RS3	175	1	St. E1	<b>167,31</b>

## Uponor RS T-Stück

 <b>1029142</b>	RS2-RS2-RS2	336	1	St. E1	<b>66,14</b>
<b>1029143</b>	RS3-RS3-RS3	175	1	St. E1	<b>179,43</b>

## Uponor RS Kupplung reduziert

 <b>1029146</b>	RS3-RS2	480	1	St. E1	<b>79,26</b>
--	---------	-----	---	-----------	--------------

## Uponor RS Distanzadapter

 <b>1046750</b>	RS2-RS2 l=5mm	480	1	St. E1	<b>60,53</b>
<b>1046751</b>	RS3-RS3 l=5mm	240	1	St. E1	<b>74,01</b>

## Uponor RS Distanzadapter

 <b>1046477</b>	RS2-RS2 l=130mm	240	1	St. E1	<b>106,73</b>
<b>1046478</b>	RS3-RS3 l=210mm	96	1	St. E1	<b>202,46</b>

## Uponor RS Adapter S-Press

 <b>1059397</b>	16-RS2	480	1	St. E1	<b>44,02</b>
--	--------	-----	---	-----------	--------------

## Uponor RS Adapter S-Press PLUS

 <b>1095818</b>	20-RS2	378	1	St. E1	<b>37,33</b>
<b>1095819</b>	25-RS2	378	1	St. E1	<b>37,33</b>
<b>1095820</b>	32-RS2	378	1	St. E1	<b>37,33</b>

Art-Nr.	Dimension	LE	VE	ME RG	Preis/ME
---------	-----------	----	----	----------	----------

## Uponor RS Adapter S-Press

 <b>1046940</b>	40-RS2	480	1	St. E1	<b>36,74</b>
<b>1046941</b>	50-RS2	480	1	St. E1	<b>38,58</b>
<b>1029125</b>	63-RS2	400	1	St. E1	<b>46,46</b>
<b>1029126</b>	75-RS2	400	1	St. E1	<b>71,45</b>
<b>1029127</b>	90-RS3	240	1	St. E1	<b>134,28</b>
<b>1029128</b>	110-RS3	240	1	St. E1	<b>161,75</b>

## Uponor RS Gewindeadapter Nippel

 <b>1059402</b>	R1 1/2"MT-RS2	480	1	St. E1	<b>47,65</b>
<b>1029131</b>	R2"MT-RS2	480	1	St. E1	<b>47,33</b>
<b>1029132</b>	R2 1/2"MT-RS2	480	1	St. E1	<b>70,47</b>
<b>1029133</b>	R3"MT-RS3	240	1	St. E1	<b>81,49</b>

## Uponor RS Gewindeadapter Muffe

 <b>1059403</b>	Rp1/2"FT-RS2	480	1	St. E1	<b>42,37</b>
<b>1029134</b>	Rp1"FT-RS2	480	1	St. E1	<b>46,38</b>
<b>1029135</b>	Rp2"FT-RS2	480	1	St. E1	<b>55,60</b>
<b>1029136</b>	Rp2 1/2"FT-RS2	480	1	St. E1	<b>81,40</b>
<b>1059404</b>	Rp1/2"FT-RS3	336	1	St. E1	<b>59,44</b>
<b>1029137</b>	Rp3"FT-RS3	240	1	St. E1	<b>74,92</b>

## Uponor RS Flansch Adapter

 <b>1059398</b>	RS2-DN65 (PN6)	144	1	St. E1	<b>243,84</b>
<b>1059399</b>	RS2-DN65 (PN16)	90	1	St. E1	<b>288,48</b>
<b>1059400</b>	RS3-DN80 (PN6)	90	1	St. E1	<b>297,89</b>
<b>1029129</b>	RS3-DN80 (PN16)	90	1	St. E1	<b>313,50</b>
<b>1059401</b>	RS3-DN100 (PN6)	90	1	St. E1	<b>324,55</b>
<b>1029130</b>	RS3-DN100 (PN16)	90	1	St. E1	<b>341,04</b>

## Uponor RS Verriegelungselement

 <b>1042921</b>	RS2 black	5000	10	St. U2	<b>22,46</b>
<b>1042922</b>	RS3 grey	-	10	St. U2	<b>51,54</b>

Preis pro VPE

# Flächenheizung/-kühlung

	Installationsart	System-Platten-dicke	Min-dest-Aufbau-höhe* mm	Systemname	Beschreibung	Zugehörige Systemrohre	Dimen-sion (mm)	
BODEN	NASSBAU	Noppenplatten-verlegung, selbstklebend	—	15	<b>Uponor Minitec</b>	sehr geringe Aufbauhöhe, direkt auf altem Untergrund (Estrich, Fliesen, Holz..)	<b>Comfort Pipe</b>	9,9
		Kletten	DES 25-2 30-2 30-3 35-3 WLS032 25-2	74	<b>Uponor Klett</b>	Mikroverzahnung von Systemplatte und Rohr. Schnellste Verlegeart, keine Beschädigung der Estrichfolie	<b>Klett Comfort Pipe PLUS</b> <b>Klett MLCP RED</b>	14, 16 16
		Kletten auf bauseitiger Dämmung	—	74	<b>Uponor Klett Twinboard</b>	Klettverlegung auf bauseitiger Dämmung mittels Hohlkammer-Verlegeplatten 3 mm	<b>Klett Comfort Pipe PLUS</b> <b>Klett MLCP RED</b>	14, 16 16
		Kletten inkl. Mineralwolle-Dämmung	30	74	<b>Uponor Klett Silent</b>	Klettverlegung auf Mineralwolleplatten, alternative Ausschreibungen	<b>Klett Comfort Pipe PLUS</b> <b>Klett MLCP RED</b>	14, 16 16
		Kletten inkl. Lüftung	30	74	<b>Uponor Comfort AIR</b>	Integration von Lüftung und Fußbodenheizung durch Anbindung an das Pluggit-Lüftungssystem	<b>Klett Comfort Pipe PLUS</b> <b>Klett MLCP RED</b>	14, 16 16
		Klett Vermeidung überheizte Flure	32	74	<b>Vario Heat Protect</b>	Rohrträger zur Führung von FBH-Anschlussleitungen unter der Heizestrichschicht	<b>alle Rohrleitungen zum Verteiler</b>	
	TROCKEN	In der Noppenfolie	—	30	<b>Uponor Nubos</b>	Freie Wahl der Dämmschicht	<b>Comfort Pipe</b> <b>Comfort Pipe PLUS</b> <b>MLCP RED</b>	16 14 14, 16
		In der Noppenplatte	11 oder 30-2	82	<b>Uponor Tecto</b>	Schnelle Rohrmontage, Systemplatten für Geschosstrenndecken, sicherer Halt	<b>Comfort Pipe PLUS</b> <b>MLCP RED</b>	14, 17 14, 16
		In der Noppenplatte	11 oder 30-2	78	<b>Uponor Nubos</b>	Einfach in der Anwendung, normgerechte Verlegeabstände	<b>Comfort Pipe</b> <b>Comfort Pipe PLUS</b> <b>MLCP RED</b>	16 14 14, 16
		auf Stahlmatten mit Clip	—	83	<b>Uponor Classic</b>	Höchster Schallschutz (bauseitige Mineralwollämmung). Trennung der Gewerke Estrich/Heizung, große Heizkreise	<b>Comfort Pipe PLUS</b> <b>Magna Pipe PLUS</b>	17 20
		Tacker und U-Schiene	EPS DEO 20, 30 DES 20-2, 30-2, 30-3, 35-3, 40-3	75	<b>Uponor Tacker</b>	Preiswerteste Lösung. Unterschiedliche Wärme-/Trittschall-dämmschichten lieferbar	<b>Comfort Pipe</b> <b>MLCP RED</b>	16 14, 16
		In vorgeformte EPS-Platten und Alu-Wärmeleitlamellen	25	50	<b>Uponor Siccus 14</b>	geringes Gewicht, sofort nutzbar, hohe Tragfähigkeit	<b>Comfort Pipe PLUS</b> <b>MLCP RED</b>	14 14
Mit vorgefertigten Kabelmatten, elektrische FBH	—	5	<b>Uponor Comfort E Kabelmatten</b>	Fest vernähte Kabelmatte, sehr geringe Aufbauhöhe, Verlegung auf nahezu allen festen Unterböden, inkl. Regler, schnelle Reaktion	—			

\* Systemplatte + Lastverteilschicht

# Uponor Systeme zum Heizen und Kühlen

		Installationsart	System-Platten-dicke	Min-dest-Aufbau-höhe* mm	Systemname	Beschreibung	Zugehörige Systemrohre	Dimen-sion (mm)
<b>WAND</b>	<b>NASS</b>	Unter Putz, mit Klemmschiene	—	32	<b>Uponor Fix</b>	Effiziente und drallfreie Rohrverlegung von der Großrolle mit minimalem Verschnitt	<b>Comfort Pipe Comfort Pipe PLUS MLCP RED</b>	9,9 14 14
	<b>TROCKEN</b>	In vorgeformten EPS-Platten	25	30	<b>Uponor Siccus Wall</b>	Keine Trocknungszeiten und kein Funktionsheizen erforderlich	<b>Comfort Pipe PLUS MLCP RED</b>	14 14
		Für Ständerwände, in Modulbauweise	—	32	<b>Uponor Siccus SW</b>	Doppelnutzen durch Nutzung von Ständerwänden als Heiz-/Kühlflächen	<b>Comfort Pipe PLUS</b>	14
		Auf CD-Profile 60/27, Gipspanel mit integrierten Heizrohren	—	15	<b>Uponor Renovis</b>	Faserverstärkte Gipsplatte 15 mm, Montage auf definierte Trockenbau-Unterkonstruktionen	<b>Comfort Pipe (integriert)</b>	9,9
<b>DECKE</b>	<b>NASS</b>	Unter Putz, mit Klemmschiene	—	32	<b>Uponor Fix</b>	Effiziente und drallfreie Rohrverlegung von der Großrolle mit minimalem Verschnitt	<b>Comfort Pipe</b>	9,9
	<b>TROCKEN</b>	Auf CD-Profile 60/27, Gipspanel mit integrierten Heizrohren	—	15	<b>Uponor Renovis</b>	Hohe Verlegeleistungen auf CD-Profilen	<b>Comfort Pipe (integriert)</b>	9,9
		Gipspanel inkl. EPS-Dämmung	27	27	<b>Uponor Teporis</b>	27 mm EPS Wärmedämmplatte	<b>Comfort Pipe (integriert)</b>	9,9
		Standard Unterkonstruktionen	—	15	<b>Uponor Thertatop M</b>	Fugen- und richtungslose Deckenoberflächen	<b>Uni Pipe PLUS</b>	16
<b>WEITERE ANWENDUNGEN</b>	<b>HALLEN</b>	<b>INDUSTRIEFLÄCHENHEIZUNG</b>						
		auf Klemmschiene			<b>Uponor Magna</b>	Optimale Raumnutzung ohne störende Anlagenkomponenten	<b>Magna Pipe PLUS</b>	20, 25
		auf Stahlmatten						
	<b>TABS</b>	<b>BETONKERNAKTIVIERUNG</b>						
		Vorgefertigte Module auf Stahlmatte (Bewehrung)			<b>Uponor Contec</b>	Für die Einbringung in den Betonkern	<b>Magna Pipe PLUS</b>	20
		Oberflächennah			<b>Uponor Contec ON</b>	Diagonal verspannte Wabengitter mit vorbereiteten Rohren zum oberflächennahen Einbau in die Betonschalung	<b>Comfort Pipe PLUS Magna Pipe PLUS</b>	14 20
	<b>TROCKEN</b>	<b>SPORTBODEN</b>						
		In Sporthallen	30		<b>Uponor Siccus Sport</b>	für flächenelastische Sportböden in Sandwichbauweise	<b>Comfort Pipe PLUS MLC weiß</b>	14 14
		In Sporthallen			<b>Uponor Sport</b>	Zum Einbau zwischen Unterzügen flächenelastischer Sportböden	<b>Magna Pipe PLUS</b>	25
	<b>FREIFLÄCHE</b>	<b>FREIFLÄCHENHEIZUNG / RASEN</b>						
Schnee- und Eisfreihaltung auf Freiflächen				<b>Uponor Meltaway</b>	Montage mit Klemmschiene, für sichere Gehwege z.B. vor Krankenhauseinfahrten, Hubschrauberlandeplätzen, Tiefgaragen- und Hofeinfahrten, Flugplätzen usw.	<b>Magna Pipe PLUS</b>	20, 25	

# Flächenheizung/-kühlung

## Uponor Heizrohre und Verbindungstechniken













Typ	Ab- messung [mm]	Diffusionssperre	Rohrfarbe, Kennzeichnung	Druck [bar]	Tempe- ratur [°C]	Länge [m]	Artikel-Nr.	DIN- Certco Zerti- fikat-Nr.
<b>Comfort Pipe PLUS</b> 	14 x 2,0	PE-Xa + EVOH Sperrschicht	weiß, 2 blaue Streifen	6	70	120 240 640 960	1062883 1062884 1088166 1062885	3V372
	17 x 2,0	PE-Xa + EVOH Sperrschicht	weiß, 2 blaue Streifen	6	70	120 240 480 640	1034535 1009226 1086340 1009227	3V372
	20 x 2,0	PE-Xa + EVOH Sperrschicht	weiß, 2 blaue Streifen	6	70	60	1009229	3V372
<b>Klett Comfort Pipe PLUS</b> 	14 x 2,0	PE-Xa + EVOH Sperrschicht	weiß, 2 blaue Streifen, mit Klettband	6	70	240 640	1088479 1088480	3V372
	16 x 2,0	PE-Xa + EVOH Sperrschicht	weiß, 2 blaue Streifen, mit Klettband	6	70	240 640	1087302 1087303	3V372
<b>Magna Pipe PLUS</b> 	20 x 2,0	PE-Xa + EVOH Sperrschicht	weiß, 2 blaue Streifen	6	70	240 480	1091275 1091276	3V415
	25 x 2,3	PE-Xa + EVOH Sperrschicht	weiß, 2 blaue Streifen	6	70	300 640	1091277 1091278	3V415
<b>Comfort Pipe</b> 	16 x 1,8	PE-Xa + EVOH Sperrschicht	weiß, 1 blauer Streifen	6	70	240 640	1047622 1047623	3V417
<b>Minitec Comfort Pipe</b> 	9,9 x 1,1	PE-Xa + EVOH Sperrschicht	natur, 1 blauer Streifen	6	70	60 120 480	1063287 1063288 1063381	3V279
<b>MLC Rohr weiß</b> 	14 x 2,0	Verbundrohr mit AL	weiß	10	80	200	1013366	
<b>MLCP RED</b> 	14 x 1,6	Verbundrohr mit AL	rot, innen blau	4	60	240 480	1096010 1096011	3V286
	16 x 2,0	Verbundrohr mit AL	rot, innen blau	4	60	240 480	1096012 1096013	3V286
<b>MLCP RED Klett</b> 	16 x 2,0	Verbundrohr mit AL	weiß, innen blau, 2 rote Streifen, mit Klettband	4	60	240 480	1096014 1096015	3V286













# Verbindungstechnik, Fittings und Werkzeug für Flächenheizsysteme



(Klemmring-) Verschraubungen	Quick und Easy Fittings	zugehörige Q+E-Sicherungsringe	rapex Pressfittings	Smart Presskupplungen	S-Press und S-Press-PLUS Kupplungen
Maulschlüssel handelsüblich	Q+E-Aufweitwerkzeuge	rapex Pressbacken	Pressbacken MLC UPP1 und KSP0		
Vario/Fit 14x2,0	M12 & M18	natur eval	14	14	-
Vario/Fit 17x2,0	M12 & M18	natur eval & weiß	17	-	-
Vario/Fit 20x1,9/2,0	M12 & M18	natur eval & weiß	-	20	-
Vario/Fit 14x2,0	M12 & M18	natur eval	14	14	-
Vario/Fit 16x1,8/2,0	M12 & M18	natur eval & weiß	16	16	-
Vario/Fit 20x1,9/2,0	M12 & M18	natur eval & weiß	-	20	-
Vario/Fit 25x2,3	M12 & M18	natur eval & weiß	25	-	-
Vario/Fit 16x1,8/2,0	M12 & M18	natur eval & weiß	16	16	-
Vario & Minitec 9,9 x 1,1	Hand, M12 & M18	Minitec PEX	-	-	-
Uni-X 14-3/4 Euro	-	-	-	-	14
Vario MLCP RED 14x1,6 Euro	-	-	-	-	14 MLCP RED Press-Kupplung
Uni-X 16-3/4 Euro	-	-	-	-	16
Uni-X 16-3/4 Euro	-	-	-	-	16

# Uponor Minitec

Art-Nr.	Dimension	LE	VE	ME RG	Preis/ME
<b>Uponor Minitec Folienelement</b>					
 <b>1005261</b>	15,4m <sup>2</sup> 9,9x1,1 1100x700x12mm	123,2	15,4	m <sup>2</sup> M2	<b>33,68</b>
<b>Uponor Fix Klemmschiene</b>					
 <b>1005274</b>	9,9mm c/c20mm 2,5m	25	2,5	m M2	<b>5,86</b>
<b>Uponor Minitec Randdämmstreifen klebend</b>					
 <b>1005267</b>	20m 80x8mm	200	20	m M2	<b>1,55</b>
<b>Uponor Minitec Bewegungsfugenprofil</b>					
 <b>1085980</b>	0,9m 40x10mm	600	10	St. M2	<b>10,21</b>
<b>1085981</b>	1,3m 40x10mm	600	10	St. M2	<b>12,94</b>
<b>Uponor Minitec Rohr Comfort Pipe</b>					
 <b>1063287</b>	9,9x1,1 60m	840	60	m M2	<b>3,35</b>
<b>1063288</b>	9,9x1,1 120m	1680	120	m M2	<b>3,35</b>
<b>1063381</b>	9,9x1,1 480m	2880	480	m M2	<b>3,35</b>
<b>Uponor Minitec Schutzhülse</b>					
 <b>1005269</b>	9,9mm 300x2mm	3600	30	St. M2	<b>1,67</b>
<b>Uponor Vario Eurokonusverschraubung Minitec</b>					
 <b>1005266</b>	9,9x1,1-G $\frac{3}{4}$ "Euro	100	10	St. M2	<b>10,52</b>
<b>Uponor Minitec Kupplung</b>					
 <b>1005264</b>	9,9x1,1	100	10	St. M2	<b>9,12</b>
<b>Uponor Minitec Übergangsnippel</b>					
 <b>1005265</b>	9,9-R $\frac{1}{2}$ "MT	100	10	St. M2	<b>11,19</b>
<b>Uponor Minitec Ring</b>					
 <b>1005263</b>	9,9x1,1	1600	10	St. M2	<b>0,60</b>
<b>Uponor Minitec Klemmringverschraubung</b>					
 <b>1013426</b>	9,9- $\frac{3}{4}$ "Euro	120	12	St. M2	<b>17,64</b>
<b>Uponor Minitec Schraubkupplung</b>					
 <b>1016690</b>	9,9-9,9	48	12	St. M2	<b>41,96</b>
<b>Uponor Fluvia Hosenstück</b>					
 <b>1005675</b>	2xG $\frac{3}{4}$ - $\frac{3}{4}$ "Euro	50	1	Set M2	<b>41,50</b>

Art-Nr.	Dimension	LE	VE	ME RG	Preis/ME
<b>Uponor Fluvia T Pumpengruppe Push-12 TH-G</b>					
 <b>1095127</b>		60	1	St. M2	<b>676,94</b>
<b>Uponor Fluvia T Pumpengruppe Push-12 CH-G</b>					
 <b>1095131</b>		30	1	St. M2	<b>1593,64</b>
<b>Uponor Fluvia T Pumpengruppe Push-12 AC-G</b>					
 <b>1095128</b>		60	1	St. M2	<b>802,79</b>
<b>Uponor Fluvia T Pumpengruppe Push-12 WL-G</b>					
 <b>1095130</b>		60	1	St. M2	<b>1072,29</b>
<b>Uponor Vario Füll / Entleerungshahn</b>					
 <b>1061802</b>	$\frac{3}{4}$ " - $\frac{3}{4}$ "	10	1	Set M2	<b>64,58</b>
<b>Uponor Multi Umlenkbogen, Kunststoff</b>					
 <b>1063781</b>	12	500	50	St. M2	<b>1,21</b>
<b>Uponor Minitec Anschlussbox-UP</b>					
 <b>1005270</b>	1X	30	1	St. M2	<b>328,37</b>
<b>1005271</b>	2X	-	1	St. M2	<b>459,74</b>
<b>1005272</b>	3X	-	1	St. M2	<b>485,29</b>
Die Begrenzung der Auslegungstemperatur muss durch eine Vorregelung sichergestellt sein.					
<b>Uponor Minitec Abdeckplatte</b>					
 <b>1007251</b>		-	1	St. M2	<b>133,80</b>
<b>Uponor Base Raumfühler T-23</b>					
 <b>1058422</b>	230V RAL9010	160	1	St. M2	<b>48,77</b>
<b>Uponor Minitec Aufweitwerkzeug</b>					
 <b>1006247</b>	9,9x1,1	11	1	Set NET	<b>345,97</b>
<b>Uponor Q&amp;E Aufweitwerkzeug mit Aufweitk. M12</b>					
 <b>1063112</b>	6BAR 9,9/20	-	1	Set NET	<b>585,05</b>
<b>Uponor Q&amp;E Aufweitwerkzeug mit Aufweitk. M12/</b>					
 <b>1119375</b>	6bar 9,9RS/20	-	1	Set NET	<b>608,00</b>
<b>NEU</b> ab 01.06.2022					

# Uponor Tecto

Art-Nr.	Dimension	LE	VE	ME RG	Preis/ME
 <b>1005478</b>	EPS DES 30-2mm 14-17mm 1450x850mm	53,76	8,96	m <sup>2</sup> M4	<b>23,96</b>
<b>1005477</b>	EPS 11mm 14-17mm 1450x850mm	94,08	15,68	m <sup>2</sup> M4	<b>22,01</b>

## Uponor Tecto Diagonal-Rohrfixierung

 <b>1005482</b>	45 75mm	420	10	St. M4	<b>2,01</b>
--	---------	-----	----	-----------	-------------

## Uponor Tecto Zwillingstreifen

 <b>1005484</b>	1,4m 100mm	742,5	33,75	m M4	<b>3,63</b>
--	------------	-------	-------	---------	-------------

## Uponor Tecto Abdeckfolie

 <b>1005481</b>	1,45m 200mm	504	28	m M4	<b>3,83</b>
--	-------------	-----	----	---------	-------------

## Uponor Tecto Dämmstreifen

 <b>1005480</b>	EPS DES 30-2mm 150x1400mm	268,8	8,4	m M4	<b>5,62</b>
<b>1005479</b>	EPS 11mm 150x1400mm	716,8	22,4	m M4	<b>4,95</b>

## Uponor Multi Randdämmstreifen mit Folie

 <b>1000079</b>	150x8mm	-	200	m MZ	<b>1,29</b>
--	---------	---	-----	---------	-------------

Hinweis: Verkauf pro Verpackungseinheit.

## Uponor Multi Randdämmstreifen Klebefolie

 <b>1000080</b>	150x10mm	-	200	m MZ	<b>2,62</b>
--	----------	---	-----	---------	-------------

Hinweis: Verkauf pro Verpackungseinheit.

## Uponor Multi Dehnungsfugenprofil

 <b>1090229</b>	1800x100x10mm	720	18	m MZ	<b>12,04</b>
--	---------------	-----	----	---------	--------------

## Uponor Multi Schutzhülse

 <b>1000082</b>	20mm 300x5mm	10800	30	St. MZ	<b>1,17</b>
--	--------------	-------	----	-----------	-------------

## Uponor Comfort Pipe PLUS Rohr

 <b>1062883</b>	14x2,0 120m	1320	120	m MO	<b>2,89</b>
<b>1062884</b>	14x2,0 240m	1680	240	m MO	<b>2,89</b>
<b>1088166</b>	14x2,0 640m	1920	640	m MO	<b>2,89</b>
<b>1062885</b>	14x2,0 960m	1920	960	m MO	<b>2,89</b>
<b>1034535</b>	17x2,0 120m	840	120	m MO	<b>3,04</b>
<b>1009226</b>	17x2,0 240m	1200	240	m MO	<b>3,04</b>
<b>1086340</b>	17x2,0 480m	960	480	m MO	<b>3,04</b>
<b>1009227</b>	17x2,0 640m	1280	640	m MO	<b>3,04</b>

## Uponor Vario Klemmringverschraubung PEX

 <b>1065283</b>	14x2,0-G $\frac{3}{4}$ "FT Euro	25	1	St. MZ	<b>6,71</b>
<b>1065286</b>	17x2,0-G $\frac{3}{4}$ "FT Euro	25	1	St. MZ	<b>6,71</b>

## Uponor Fit Schraubkupplung PEX

 <b>1065299</b>	17x2,0-17x2,0	25	1	St. MZ	<b>20,72</b>
--	---------------	----	---	-----------	--------------

Art-Nr.	Dimension	LE	VE	ME RG	Preis/ME
---------	-----------	----	----	----------	----------

## Uponor Fit Übergangverschraubung PEX

 <b>1065294</b>	14x2,0-R $\frac{1}{2}$ "MT	25	1	St. MZ	<b>16,84</b>
<b>1065300</b>	17x2,0-R $\frac{1}{2}$ "MT	25	1	St. MZ	<b>14,56</b>

## Uponor Fit Übergangverschraubung PEX

 <b>1065295</b>	14x2,0-Rp $\frac{1}{2}$ "FT	25	1	St. MZ	<b>17,55</b>
--	-----------------------------	----	---	-----------	--------------

## Uponor Rapex Press-Kupplung

 <b>1005079</b>	17-17	100	10	St. MZ	<b>13,30</b>
--	-------	-----	----	-----------	--------------

## Uponor Q&E Kupplung m. Ringen DR

 <b>1058659</b>	14-14	100	10	St. MZ	<b>6,74</b>
<b>1058661</b>	17-17	100	10	St. MZ	<b>9,65</b>

## Uponor Q&E Ring natural, eval

 <b>1058428</b>	14	900	20	St. MZ	<b>0,40</b>
--	----	-----	----	-----------	-------------

## Uponor Smart Presskupplung

 <b>1089646</b>	14x2,0-14x2,0	80	20	St. MZ	<b>10,01</b>
--	---------------	----	----	-----------	--------------

## Uponor MLCP RED Rohr

 <b>1096010</b>	14x1,6 240m	3120	240	m M1	<b>1,68</b>
<b>1096011</b>	14x1,6 480m	3360	480	m M1	<b>1,68</b>
<b>1096012</b>	16x2,0 240m	3120	240	m M1	<b>2,10</b>
<b>1096013</b>	16x2,0 480m	3360	480	m M1	<b>2,10</b>

## Uponor Vario Eurokonusverschraubung MLCP RED

 <b>1000117</b>	14x1,6- $\frac{3}{4}$ "Euro	80	20	St. MZ	<b>5,79</b>
--	-----------------------------	----	----	-----------	-------------

## Uponor MLCP RED Press-Kupplung

 <b>1048272</b>	14x1,6-14x1,6	80	20	St. MZ	<b>10,72</b>
--	---------------	----	----	-----------	--------------

## Uponor S-Press PLUS Kupplung

 <b>1070547</b>	16-16	80	20	St. D1	<b>9,59</b>
--	-------	----	----	-----------	-------------

## Uponor S-Press PLUS Kupplung PPSU

 <b>1039933</b>	16-16	80	20	St. E1	<b>6,03</b>
--	-------	----	----	-----------	-------------

## Uponor Uni-X Verschraubung MLC

 <b>1058090</b>	16- $\frac{3}{4}$ "FT Euro	25	1	St. D1	<b>7,50</b>
--	----------------------------	----	---	-----------	-------------

## Uponor Multi Rohrführungsbogen Kunststoff

 <b>1000118</b>	18	250	50	St. D1	<b>3,09</b>
--	----	-----	----	-----------	-------------



# Uponor Nubos

Art-Nr.	Dimension	LE	VE	ME RG	Preis/ME
---------	-----------	----	----	----------	----------



## Uponor Nubos Noppenplatte

 <b>1016699</b>	EPS 30-2 14-16mm 1447x900x48mm	60	10	m <sup>2</sup> M4	<b>22,99</b>
<b>1016700</b>	EPS 11 14-16mm 1447x900x29mm	100	10	m <sup>2</sup> M4	<b>21,48</b>

## Uponor Nubos Noppenfolie

 <b>1016703</b>	14-16mm	140	10	m <sup>2</sup> M9	<b>12,69</b>
<b>1061880</b>	14-16mm	-	200	m <sup>2</sup> M9	<b>12,10</b>

## Uponor Nubos Noppen-Verteiler-/Tür Set

 <b>1016701</b>	EPS 30-2 14-16mm 1447x900x48mm	50	5	m <sup>2</sup> M4	<b>26,88</b>
 <b>1016702</b>	EPS 11 14-16mm 1447x900x29mm	50	5	m <sup>2</sup> M4	<b>24,14</b>

## Uponor Multi Randdämmstreifen mit Folie

 <b>1000079</b>	150x8mm	-	200	m MZ	<b>1,29</b>
--	---------	---	-----	---------	-------------

Hinweis: Verkauf pro Verpackungseinheit.

## Uponor Multi Randdämmstreifen Klebefolie

 <b>1000080</b>	150x10mm	-	200	m MZ	<b>2,62</b>
---	----------	---	-----	---------	-------------

Hinweis: Verkauf pro Verpackungseinheit.

## Uponor Multi Dehnungsfugenprofil

 <b>1090229</b>	1800x100x10mm	720	18	m MZ	<b>12,04</b>
--	---------------	-----	----	---------	--------------

## Uponor Multi Schutzhülse

 <b>1000082</b>	20mm 300x5mm	10800	30	St. MZ	<b>1,17</b>
--	--------------	-------	----	-----------	-------------

## Uponor Fix Klemmschiene selbstklebend

 <b>1000018</b>	14-20mm c/c50mm 1m	600	100	m M8	<b>5,76</b>
--	--------------------	-----	-----	---------	-------------

## Uponor Comfort Pipe PLUS Rohr

 <b>1088166</b>	14x2,0 640m	1920	640	m M0	<b>2,89</b>
--	-------------	------	-----	---------	-------------

## Uponor Comfort Pipe Rohr

 <b>1047622</b>	16x1,8 240m	1440	240	m M1	<b>1,42</b>
<b>1047623</b>	16x1,8 640m	1280	640	m M1	<b>1,42</b>

Art-Nr.	Dimension	LE	VE	ME RG	Preis/ME
---------	-----------	----	----	----------	----------

## Uponor Vario Klemmringverschraubung PEX

 <b>1065283</b>	14x2,0-G $\frac{3}{4}$ "FT Euro	25	1	St. MZ	<b>6,71</b>
<b>1065284</b>	16x1,8/2,0-G $\frac{3}{4}$ "FT Euro	25	1	St. MZ	<b>6,71</b>

## Uponor Smart Presskupplung

 <b>1089646</b>	14x2,0-14x2,0	80	20	St. MZ	<b>10,01</b>
<b>1089647</b>	16x1,8/2,0-16x1,8/2,0	80	20	St. MZ	<b>11,33</b>

## Uponor MLCP RED Rohr

 <b>1096010</b>	14x1,6 240m	3120	240	m M1	<b>1,68</b>
<b>1096011</b>	14x1,6 480m	3360	480	m M1	<b>1,68</b>
<b>1096012</b>	16x2,0 240m	3120	240	m M1	<b>2,10</b>
<b>1096013</b>	16x2,0 480m	3360	480	m M1	<b>2,10</b>

## Uponor Vario Eurokonusverschraubung MLCP RED

 <b>1000117</b>	14x1,6- $\frac{3}{4}$ "Euro	80	20	St. MZ	<b>5,79</b>
--	-----------------------------	----	----	-----------	-------------

## Uponor MLCP RED Press-Kupplung

 <b>1048272</b>	14x1,6-14x1,6	80	20	St. MZ	<b>10,72</b>
--	---------------	----	----	-----------	--------------

## Uponor Uni-X Verschraubung MLC

 <b>1058090</b>	16- $\frac{3}{4}$ "FT Euro	25	1	St. D1	<b>7,50</b>
--	----------------------------	----	---	-----------	-------------

## Uponor S-Press PLUS Kupplung

 <b>1070547</b>	16-16	80	20	St. D1	<b>9,59</b>
--	-------	----	----	-----------	-------------

## Uponor S-Press PLUS Kupplung PPSU

 <b>1039933</b>	16-16	80	20	St. E1	<b>6,03</b>
--	-------	----	----	-----------	-------------

## Uponor Multi Rohrführungsbogen Kunststoff

 <b>1000118</b>	18	250	50	St. D1	<b>3,09</b>
--	----	-----	----	-----------	-------------



# Uponor Klett

Art-Nr.	Dimension	LE	VE	ME RG	Preis/ME
<b>Uponor Klett Rollplatte extra</b>					
 <b>1063402</b>	EPS DES 25-2mm 10x1m	80	10	m <sup>2</sup> M6	<b>13,30</b>
<b>1063322</b>	EPS DES 30-2mm 10x1m	80	10	m <sup>2</sup> M6	<b>15,45</b>
<b>1063323</b>	EPS DES 30-3mm 10x1m	80	10	m <sup>2</sup> M6	<b>13,61</b>
<b>1063324</b>	EPS DES 35-3mm 10x1m	70	10	m <sup>2</sup> M6	<b>14,38</b>

## Uponor Klett Rollplatte

 <b>1085788</b>	G EPS DES WLS032 25-2mm 10x1m	80	10	m <sup>2</sup> M6	<b>15,15</b>
--	----------------------------------	----	----	----------------------	--------------

## Uponor Klett Twinboard

 <b>1086854</b>	2400x1000x3mm	360	24	m <sup>2</sup> M6	<b>19,33</b>
--	---------------	-----	----	----------------------	--------------

## Uponor Vario Heat Protect Verteilerplatte

 <b>1090043</b>	27mm	116	29	St. MZ	<b>50,45</b>
--	------	-----	----	-----------	--------------

## Uponor Vario Heat Protect Rohrführungsplatte

 <b>1090044</b>	27mm	116	29	St. MZ	<b>45,29</b>
---	------	-----	----	-----------	--------------

## Uponor Vario Heat Protect Verteilerplatte mit Trittschallschutz

 <b>1091816</b>	32mm	100	25	St. MZ	<b>71,66</b>
--	------	-----	----	-----------	--------------

## Uponor Vario Heat Protect Rohrführungsplatte mit Trittschallschutz

 <b>1091817</b>	32mm	100	25	St. MZ	<b>60,03</b>
--	------	-----	----	-----------	--------------

## Uponor Multi Randdämmstreifen mit Folie

 <b>1000079</b>	150x8mm	-	200	m MZ	<b>1,29</b>
--	---------	---	-----	---------	-------------

Hinweis: Verkauf pro Verpackungseinheit.

## Uponor Multi Randdämmstreifen Klebefolie

 <b>1000080</b>	150x10mm	-	200	m MZ	<b>2,62</b>
--	----------	---	-----	---------	-------------

Hinweis: Verkauf pro Verpackungseinheit.

## Uponor Multi Dehnungsfugenprofil

 <b>1090229</b>	1800x100x10mm	720	18	m MZ	<b>12,04</b>
--	---------------	-----	----	---------	--------------

## Uponor Multi Schutzhülse

 <b>1000082</b>	20mm 300x5mm	10800	30	St. MZ	<b>1,17</b>
--	--------------	-------	----	-----------	-------------

Art-Nr.	Dimension	LE	VE	ME RG	Preis/ME
---------	-----------	----	----	----------	----------

## Uponor Klett Panel Silent

 <b>1088065</b>	1200x1000x30mm	48	4,8	m <sup>2</sup> M6	<b>50,11</b>
--	----------------	----	-----	----------------------	--------------

## Uponor Klett Randdämmstreifen

 <b>1089919</b>	1200X120X13mm	1536	96	m M6	<b>5,63</b>
--	---------------	------	----	---------	-------------

## Uponor Klett Abdichtstreifen

 <b>1089951</b>	50m 280x0,2mm	6000	50	m M6	<b>6,34</b>
--	---------------	------	----	---------	-------------

## Uponor Klett Klebeband spezial

 <b>1007178</b>	20m 50mm	30	5	St. U1	<b>21,71</b>
--	----------	----	---	-----------	--------------

## Uponor Multi Klebeband

 <b>1000012</b>	66m 50mm	36	1	St. MZ	<b>6,19</b>
--	----------	----	---	-----------	-------------

## Uponor Multi Klebebandabroller

 <b>1000142</b>		20	1	St. NET	<b>27,40</b>
--	--	----	---	------------	--------------

# Uponor Klett

Art-Nr.	Dimension	LE	VE	ME RG	Preis/ME
<b>Uponor Klett Rohr Comfort Pipe PLUS</b>					
 <b>1088479</b>	14x2,0 240m	1440	240	m M6	<b>2,18</b>
<b>1088480</b>	14x2,0 640m	1280	640	m M6	<b>2,18</b>
<b>1087302</b>	16x2,0 240m	1200	240	m M6	<b>2,28</b>
<b>1087303</b>	16x2,0 640m	1280	640	m M6	<b>2,28</b>

## Uponor Vario Klemmringverschraubung PEX

 <b>1065283</b>	14x2,0-G¾"FT Euro	25	1	St. MZ	<b>6,71</b>
<b>1065284</b>	16x1,8/2,0-G¾"FT Euro	25	1	St. MZ	<b>6,71</b>

## Uponor Smart Presskupplung

 <b>1089646</b>	14x2,0-14x2,0	80	20	St. MZ	<b>10,01</b>
<b>1089647</b>	16x1,8/2,0-16x1,8/2,0	80	20	St. MZ	<b>11,33</b>

## Uponor Fit Schraubkupplung PEX

 <b>1065296</b>	16x1,8/2,0-16x1,8/2,0	25	1	St. MZ	<b>21,80</b>
--	-----------------------	----	---	-----------	--------------

## Uponor Fit Übergangverschraubung PEX

 <b>1065294</b>	14x2,0-R½"MT	25	1	St. MZ	<b>16,84</b>
<b>1065297</b>	16x1,8/2,0-R½"MT	25	1	St. MZ	<b>17,74</b>

## Uponor Fit Übergangverschraubung PEX

 <b>1065295</b>	14x2,0-Rp½"FT	25	1	St. MZ	<b>17,55</b>
<b>1065298</b>	16x1,8/2,0-Rp½"FT	25	1	St. MZ	<b>16,90</b>

## Uponor Q&E Kupplung m. Ringen DR

 <b>1058659</b>	14-14	100	10	St. MZ	<b>6,74</b>
<b>1058660</b>	16x1,8/2,0-16x1,8/2,0	100	10	St. MZ	<b>8,15</b>

## Uponor Q&E Ring natural, eval

 <b>1058428</b>	14	900	20	St. MZ	<b>0,40</b>
--	----	-----	----	-----------	-------------

## Uponor Q&E Sicherungsring white

 <b>1057453</b>	16	900	20	St. F1	<b>0,42</b>
--	----	-----	----	-----------	-------------

Art-Nr.	Dimension	LE	VE	ME RG	Preis/ME
<b>Uponor Klett Rohr MLCP RED</b>					
 <b>1096014</b>	16X2,0 240M	1920	240	m M6	<b>2,60</b>
<b>1096015</b>	16X2,0 480M	2400	480	m M6	<b>2,60</b>

## Uponor Uni-X Verschraubung MLC

 <b>1058090</b>	16-¾"FT Euro	25	1	St. D1	<b>7,50</b>
--	--------------	----	---	-----------	-------------

## Uponor S-Press PLUS Kupplung

 <b>1070547</b>	16-16	80	20	St. D1	<b>9,59</b>
--	-------	----	----	-----------	-------------

## Uponor Multi Rohrührungsbogen Kunststoff

 <b>1000118</b>	18	250	50	St. D1	<b>3,09</b>
--	----	-----	----	-----------	-------------

## Uponor Multi Rohrhalterung

 <b>1088066</b>		-	1	St. NET	<b>260,00</b>
--	--	---	---	------------	---------------

 Lieferung solange Vorrat reicht. Artikel läuft im Laufe des Jahres aus.

# Uponor Tacker

Art-Nr.	Dimension	LE	VE	ME RG	Preis/ME
 <b>1090921</b>	EPS DES 20-2mm 10x1m	100	10	m <sup>2</sup> M7	<b>9,45</b>
<b>1090924</b>	EPS DES 30-2mm 10x1m	80	10	m <sup>2</sup> M7	<b>11,30</b>
<b>1090925</b>	EPS DES 30-3mm 10x1m	80	10	m <sup>2</sup> M7	<b>10,30</b>
<b>1090926</b>	EPS DES 35-3mm 10x1m	70	10	m <sup>2</sup> M7	<b>11,40</b>
<b>1090927</b>	EPS DES 40-3mm 10x1m	60	10	m <sup>2</sup> M7	<b>12,40</b>

## Uponor Tacker Panel

 <b>1090917</b>	EPS DEO 20	100	10	m <sup>2</sup> M7	<b>10,00</b>
<b>1090918</b>	EPS DEO 30	80	10	m <sup>2</sup> M7	<b>18,20</b>

## Uponor Tacker Folie transparent

 <b>NEU</b> <b>1122372</b>	0,2mm 100x1,03m	2884	103	m <sup>2</sup>	<b>4,05</b>
---	-----------------	------	-----	----------------	-------------

## Uponor Multi Randdämmstreifen mit Folie

 <b>1000079</b>	150x8mm	-	200	m MZ	<b>1,29</b>
--	---------	---	-----	---------	-------------

Hinweis: Verkauf pro Verpackungseinheit.

## Uponor Multi Randdämmstreifen Klebefolie

 <b>1000080</b>	150x10mm	-	200	m MZ	<b>2,62</b>
--	----------	---	-----	---------	-------------

Hinweis: Verkauf pro Verpackungseinheit.

## Uponor Multi Dehnungsfugenprofil

 <b>1090229</b>	1800x100x10mm	720	18	m MZ	<b>12,04</b>
--	---------------	-----	----	---------	--------------

## Uponor Multi Schutzhülse

 <b>1000082</b>	20mm 300x5mm	10800	30	St. MZ	<b>1,17</b>
--	--------------	-------	----	-----------	-------------

## Uponor Multi Klebeband

 <b>1000012</b>	66m 50mm	36	1	St. MZ	<b>6,19</b>
--	----------	----	---	-----------	-------------

## Uponor Multi Klebebandabroller

 <b>1000142</b>		20	1	St. NET	<b>27,40</b>
--	--	----	---	------------	--------------

Art-Nr.	Dimension	LE	VE	ME RG	Preis/ME
 <b>1047622</b>	16x1,8 240m	1440	240	m M1	<b>1,42</b>
<b>1047623</b>	16x1,8 640m	1280	640	m M1	<b>1,42</b>

## Uponor Vario Klemmringverschraubung PEX

 <b>1065284</b>	16x1,8/2,0-G <sup>3</sup> / <sub>4</sub> "FT Euro	25	1	St. MZ	<b>6,71</b>
--	---	----	---	-----------	-------------

## Uponor Fit Schraubkupplung PEX

 <b>1065296</b>	16x1,8/2,0-16x1,8/2,0	25	1	St. MZ	<b>21,80</b>
--	-----------------------	----	---	-----------	--------------

## Uponor Smart Presskupplung

 <b>1089647</b>	16x1,8/2,0-16x1,8/2,0	80	20	St. MZ	<b>11,33</b>
--	-----------------------	----	----	-----------	--------------

# Uponor Tacker

Art-Nr.	Dimension	LE	VE	ME RG	Preis/ME
<b>Uponor MLCP RED Rohr</b>					
 <b>1096010</b>	14x1,6 240m	3120	240	m M1	<b>1,68</b>
<b>1096011</b>	14x1,6 480m	3360	480	m M1	<b>1,68</b>
<b>1096012</b>	16x2,0 240m	3120	240	m M1	<b>2,10</b>
<b>1096013</b>	16x2,0 480m	3360	480	m M1	<b>2,10</b>

## Uponor Vario Eurokonusverschraubung MLCP RED

 <b>1000117</b>	14x1,6-¾" Euro	80	20	St. MZ	<b>5,79</b>
--	----------------	----	----	-----------	-------------

## Uponor MLCP RED Press-Kupplung

 <b>1048272</b>	14x1,6-14x1,6	80	20	St. MZ	<b>10,72</b>
--	---------------	----	----	-----------	--------------

## Uponor Uni-X Verschraubung MLC

 <b>1058090</b>	16-¾" FT Euro	25	1	St. D1	<b>7,50</b>
--	---------------	----	---	-----------	-------------

## Uponor S-Press PLUS Kupplung

 <b>1070547</b>	16-16	80	20	St. D1	<b>9,59</b>
--	-------	----	----	-----------	-------------

## Uponor S-Press PLUS Kupplung PPSU

 <b>1039933</b>	16-16	80	20	St. E1	<b>6,03</b>
--	-------	----	----	-----------	-------------

Art-Nr.	Dimension	LE	VE	ME RG	Preis/ME
---------	-----------	----	----	----------	----------

## Uponor Tacker Nadel kurz

 <b>1086528</b>	14-20mm h=35mm	6000	300	St. M7	<b>0,15</b>
--	----------------	------	-----	-----------	-------------

## Uponor Tacker Nadel

 <b>1086529</b>	14-20mm h=40mm	75000	1000	St. M7	<b>0,06</b>
--	----------------	-------	------	-----------	-------------

## Uponor Tacker Nadel lang

 <b>1086530</b>	55mm	4800	300	St. M7	<b>0,30</b>
--	------	------	-----	-----------	-------------

## Uponor Tacker Werkzeug

 <b>1119039</b>	14-20mm	50	1	St. NET	<b>243,06</b>
--	---------	----	---	------------	---------------

## Uponor Multi Rohrführungsbogen Kunststoff

 <b>1000118</b>	18	250	50	St. D1	<b>3,09</b>
<b>1001229</b>	20	2300	50	St. D1	<b>3,81</b>

# Uponor Fix

Art-Nr.	Dimension	LE	VE	ME RG	Preis/ME
---------	-----------	----	----	----------	----------

## Uponor Fix Klemmschiene

 <b>1005498</b>	14mm c/c50mm 2,5m	-	25	m M <sup>6</sup>	<b>4,95</b>
--	-------------------	---	----	---------------------	-------------

## Uponor Fix Klemmschiene

 <b>1005274</b>	9,9mm c/c20mm 2,5m	25	2,5	m M2	<b>5,86</b>
--	--------------------	----	-----	---------	-------------

## Uponor Comfort Pipe PLUS Rohr

 <b>1062883</b>	14x2,0 120m	1320	120	m M0	<b>2,89</b>
<b>1062884</b>	14x2,0 240m	1680	240	m M0	<b>2,89</b>
<b>1062885</b>	14x2,0 960m	1920	960	m M0	<b>2,89</b>
<b>1009229</b>	20x2,0 60m	660	60	m M0	<b>3,08</b>

## Uponor Magna pipe PLUS

 <b>1091275</b>	20x2,0 240m	960	240	m B7	<b>3,04</b>
<b>1091276</b>	20x2,0 480m	960	480	m B7	<b>3,04</b>

## Uponor Minitec Rohr Comfort Pipe

 <b>1063287</b>	9,9x1,1 60m	840	60	m M2	<b>3,35</b>
<b>1063288</b>	9,9x1,1 120m	1680	120	m M2	<b>3,35</b>
<b>1063381</b>	9,9x1,1 480m	2880	480	m M2	<b>3,35</b>

## Uponor Vario Klemmringverschraubung PEX

 <b>1065283</b>	14x2,0-G $\frac{3}{4}$ "FT Euro	25	1	St. MZ	<b>6,71</b>
<b>1065290</b>	20x1,9/2,0-G $\frac{3}{4}$ "FT Euro	25	1	St. MZ	<b>7,01</b>

## Uponor Smart Presskupplung

 <b>1089646</b>	14x2,0-14x2,0	80	20	St. MZ	<b>10,01</b>
--	---------------	----	----	-----------	--------------

## Uponor Fit Übergangverschraubung PEX

 <b>1065294</b>	14x2,0-R $\frac{1}{2}$ "MT	25	1	St. MZ	<b>16,84</b>
--	----------------------------	----	---	-----------	--------------

## Uponor Fit Übergangverschraubung PEX

 <b>1065295</b>	14x2,0-Rp $\frac{1}{2}$ "FT	25	1	St. MZ	<b>17,55</b>
--	-----------------------------	----	---	-----------	--------------

## Uponor Q&E Kupplung m. Ringen DR

 <b>1058659</b>	14-14	100	10	St. MZ	<b>6,74</b>
--	-------	-----	----	-----------	-------------

## Uponor Q&E Ring natural, eval

 <b>1058428</b>	14	900	20	St. MZ	<b>0,40</b>
--	----	-----	----	-----------	-------------

## Uponor Q&E Sicherungsring white

 <b>1057454</b>	20	520	20	St. F1	<b>0,57</b>
--	----	-----	----	-----------	-------------

Art-Nr.	Dimension	LE	VE	ME RG	Preis/ME
---------	-----------	----	----	----------	----------

## Uponor MLCP RED Rohr

 <b>1096010</b>	14x1,6 240m	3120	240	m M1	<b>1,68</b>
<b>1096011</b>	14x1,6 480m	3360	480	m M1	<b>1,68</b>

## Uponor Vario Eurokonusverschraubung MLCP RED

 <b>1000117</b>	14x1,6- $\frac{3}{4}$ "Euro	80	20	St. MZ	<b>5,79</b>
--	-----------------------------	----	----	-----------	-------------

## Uponor MLCP RED Press-Kupplung

 <b>1048272</b>	14x1,6-14x1,6	80	20	St. MZ	<b>10,72</b>
--	---------------	----	----	-----------	--------------

## Uponor Minitec Ring

 <b>1005263</b>	9,9x1,1	1600	10	St. M2	<b>0,60</b>
--	---------	------	----	-----------	-------------

## Uponor Vario Eurokonusverschraubung Minitec

 <b>1005266</b>	9,9x1,1-G $\frac{3}{4}$ "Euro	100	10	St. M2	<b>10,52</b>
--	-------------------------------	-----	----	-----------	--------------

## Uponor Minitec Kupplung

 <b>1005264</b>	9,9x1,1	100	10	St. M2	<b>9,12</b>
---	---------	-----	----	-----------	-------------

## Uponor Minitec T-Stück reduziert Q&E

 <b>1020524</b>	20xMinitec9,9xQ&E20	75	5	St. MZ	<b>13,78</b>
--	---------------------	----	---	-----------	--------------

## Uponor Minitec Übergangsnippel

 <b>1005265</b>	9,9-R $\frac{1}{2}$ "MT	100	10	St. M2	<b>11,19</b>
--	-------------------------	-----	----	-----------	--------------

## Uponor Minitec Kupplung red. Q&E

 <b>1020518</b>	20xMinitec9,9	150	5	St. MZ	<b>15,45</b>
--	---------------	-----	---	-----------	--------------

## Uponor Minitec Aufweitwerkzeug

 <b>1006247</b>	9,9x1,1	11	1	Set NET	<b>345,97</b>
--	---------	----	---	------------	---------------

## Uponor Q&E Aufweitwerkzeug mit Aufweitk. M12

 <b>1063112</b>	6BAR 9,9/20	-	1	Set NET	<b>585,05</b>
--	-------------	---	---	------------	---------------

## Uponor Q&E Aufweitwerkzeug mit Aufweitk. M12/

 <b>NEU</b> <b>1119375</b>	6bar 9,9RS/20	-	1	Set NET	<b>608,00</b>
---	---------------	---	---	------------	---------------

**NEU** ab 01.06.2022

## Uponor Multi Umlenkbogen, Kunststoff

 <b>1063781</b>	12	500	50	St. M2	<b>1,21</b>
--	----	-----	----	-----------	-------------

# Uponor Classic

Art-Nr.	Dimension	LE	VE	ME RG	Preis/ME
---------	-----------	----	----	----------	----------

## Uponor Classic Stahlmatte beschichtet

 <b>1005085</b>	50mm 2150x750x3mm	450	15	m <sup>2</sup> M5	<b>23,11</b>
<b>1005084</b>	100mm 2100x1200x3mm	750	25	m <sup>2</sup> M5	<b>10,52</b>
<b>1005087</b>	150mm 2100x1200x3mm	750	25	m <sup>2</sup> M5	<b>8,75</b>

## Uponor Classic Stahlmatte

 <b>1063406</b>	100mm 2100x1200x3mm	750	25	m <sup>2</sup> M5	<b>8,33</b>
<b>1063407</b>	150mm 2100x1200x3mm	750	25	m <sup>2</sup> M5	<b>5,94</b>

## Uponor Classic Mattenbinder

 <b>1007393</b>	80mm (100pce/set)	2500	50	Set M5	<b>4,40</b>
--	-------------------	------	----	-----------	-------------

## Uponor Classic Rohralter

 <b>1005189</b>	17mm 3mm	500	500	St. M5	<b>0,35</b>
<b>1005190</b>	20mm 3mm	2800	280	St. M5	<b>0,51</b>

## Uponor Multi Randdämmstreifen mit Folie

 <b>1000079</b>	150x8mm	-	200	m MZ	<b>1,29</b>
--	---------	---	-----	---------	-------------

Hinweis: Verkauf pro Verpackungseinheit.

## Uponor Multi Randdämmstreifen Klebefolie

 <b>1000080</b>	150x10mm	-	200	m MZ	<b>2,62</b>
--	----------	---	-----	---------	-------------

Hinweis: Verkauf pro Verpackungseinheit.

## Uponor Multi Dehnungsfugenprofil

 <b>1090229</b>	1800x100x10mm	720	18	m MZ	<b>12,04</b>
--	---------------	-----	----	---------	--------------

## Uponor Multi Schutzhülse

 <b>1000082</b>	20mm 300x5mm	10800	30	St. MZ	<b>1,17</b>
--	--------------	-------	----	-----------	-------------

## Uponor Comfort Pipe PLUS Rohr

 <b>1034535</b>	17x2,0 120m	840	120	m M0	<b>3,04</b>
<b>1009226</b>	17x2,0 240m	1200	240	m M0	<b>3,04</b>
<b>1086340</b>	17x2,0 480m	960	480	m M0	<b>3,04</b>
<b>1009227</b>	17x2,0 640m	1280	640	m M0	<b>3,04</b>

## Uponor Magna pipe PLUS

 <b>1091275</b>	20x2,0 240m	960	240	m B7	<b>3,04</b>
<b>1091276</b>	20x2,0 480m	960	480	m B7	<b>3,04</b>

Art-Nr.	Dimension	LE	VE	ME RG	Preis/ME
---------	-----------	----	----	----------	----------

## Uponor Vario Klemmringverschraubung PEX

 <b>1065286</b>	17x2,0-G $\frac{3}{4}$ "FT Euro	25	1	St. MZ	<b>6,71</b>
<b>1065290</b>	20x1,9/2,0-G $\frac{3}{4}$ "FT Euro	25	1	St. MZ	<b>7,01</b>

## Uponor Fit Schraubkupplung PEX

 <b>1065299</b>	17x2,0-17x2,0	25	1	St. MZ	<b>20,72</b>
<b>1065302</b>	20x1,9/2,0-20x1,9/2,0	25	1	St. MZ	<b>33,55</b>

## Uponor Smart Presskupplung

 <b>1089648</b>	20x2,0-20x2,0	80	20	St. MZ	<b>12,64</b>
--	---------------	----	----	-----------	--------------

## Uponor Fit Übergangverschraubung PEX

 <b>1065300</b>	17x2,0-R $\frac{1}{2}$ "MT	25	1	St. MZ	<b>14,56</b>
<b>1065305</b>	20x1,9/2,0-R $\frac{3}{4}$ "MT	25	1	St. MZ	<b>22,05</b>

## Uponor Fit Übergangverschraubung PEX

 <b>1065306</b>	20x1,9/2,0-Rp $\frac{3}{4}$ "FT	25	1	St. MZ	<b>22,83</b>
--	---------------------------------	----	---	-----------	--------------

## Uponor Rapex Press-Kupplung

 <b>1005079</b>	17-17	100	10	St. MZ	<b>13,30</b>
--	-------	-----	----	-----------	--------------

## Uponor Q&E Kupplung m. Ringen DR

 <b>1058661</b>	17-17	100	10	St. MZ	<b>9,65</b>
<b>1058668</b>	20-20	80	10	St. MZ	<b>9,65</b>

## Uponor Multi Rohrführungsbogen Kunststoff

 <b>1000118</b>	18	250	50	St. D1	<b>3,09</b>
<b>1001229</b>	20	2300	50	St. D1	<b>3,81</b>

## Uponor Classic Clipmaster

<b>1006295</b>	16/17mm l=920mm	100	1	St. NET	<b>220,00</b>
<b>1006309</b>	20mm l=920mm	-	1	St. NET	<b>335,30</b>

## Uponor Classic Drillgerät f.Mattenbinder

 <b>1006243</b>	l=320mm	50	1	St. NET	<b>23,18</b>
--	---------	----	---	------------	--------------

# Uponor Comfort E

Art-Nr.	Dimension	LE	VE	ME RG	Preis/ME
<b>Uponor Comfort E Kabelmatte set T-87IF</b>					
 <b>1088668</b>	160-1	50	1	Set MC	<b>323,54</b>
<b>1088669</b>	160-1,5	50	1	Set MC	<b>378,23</b>
<b>1088670</b>	160-2	50	1	Set MC	<b>397,72</b>
<b>1088671</b>	160-2,5	50	1	Set MC	<b>452,43</b>
<b>1088672</b>	160-3	50	1	Set MC	<b>465,81</b>
<b>1088673</b>	160-4	35	1	Set MC	<b>525,44</b>
<b>1088674</b>	160-5	35	1	Set MC	<b>580,15</b>
<b>1088675</b>	160-6	35	1	Set MC	<b>644,45</b>
<b>1088676</b>	160-7	20	1	Set MC	<b>699,16</b>
<b>1088677</b>	160-8	20	1	Set MC	<b>735,81</b>
<b>1088678</b>	160-10	20	1	Set MC	<b>796,61</b>
<b>1088679</b>	160-12	20	1	Set MC	<b>918,23</b>

## Uponor Comfort E Kabelmatte

 <b>1088656</b>	160-1	50	1	Set MC	<b>131,35</b>
<b>1088657</b>	160-1,5	50	1	Set MC	<b>177,55</b>
<b>1088658</b>	160-2	50	1	Set MC	<b>203,13</b>
<b>1088659</b>	160-2,5	50	1	Set MC	<b>268,81</b>
<b>1088660</b>	160-3	50	1	Set MC	<b>282,17</b>
<b>1088661</b>	160-4	35	1	Set MC	<b>367,31</b>
<b>1088662</b>	160-5	35	1	Set MC	<b>432,48</b>
<b>1088663</b>	160-6	35	1	Set MC	<b>512,03</b>
<b>1088664</b>	160-7	20	1	Set MC	<b>589,73</b>
<b>1088665</b>	160-8	20	1	Set MC	<b>655,25</b>
<b>1088666</b>	160-10	20	1	Set MC	<b>720,78</b>
<b>1088667</b>	160-12	20	1	Set MC	<b>857,27</b>

Art-Nr.	Dimension	LE	VE	ME RG	Preis/ME
<b>Uponor Comfort E Analoges Thermostat set T-85</b>					
 <b>1088705</b>	230V	-	1	Set MC	<b>124,50</b>

## Uponor Comfort E Unterputzthermostat - digital programmierbar - flush Set T-87IF

 <b>1088706</b>	230V	-	1	Set MC	<b>249,35</b>
--	------	---	---	-----------	---------------

## Uponor Comfort E Bodenfühler T-85, T-87

 <b>1090944</b>		100	1	St. MC	<b>27,54</b>
--	--	-----	---	-----------	--------------

INHALT

Installation

Flächenheizung  
und -kühlungNahwärme-  
versorgung

Werkzeuge

Anhang

# Uponor Siccus 14

Art-Nr.	Dimension	LE	VE	ME RG	Preis/ME
---------	-----------	----	----	----------	----------

## Uponor Siccus 14 Verlegeplatte

 <b>1005485</b>	EPS 150kPa 14mm 1197x1050x25mm	100	12,5	$\frac{m^2}{M^3}$	<b>18,13</b>
--	-----------------------------------	-----	------	-------------------	--------------

## Uponor Siccus 14 Wärmeleitlamelle

 <b>1005486</b>	14mm 1180x120x0,45mm	768	48	$\frac{St.}{M^3}$	<b>6,38</b>
--	----------------------	-----	----	-------------------	-------------

## Uponor Multi Randdämmstreifen mit Folie

 <b>1000079</b>	150x8mm	-	200	$\frac{m}{MZ}$	<b>1,29</b>
--	---------	---	-----	----------------	-------------

Hinweis: Verkauf pro Verpackungseinheit.

## Uponor Comfort Pipe PLUS Rohr

 <b>1062883</b>	14x2,0 120m	1320	120	$\frac{m}{MO}$	<b>2,89</b>
<b>1062884</b>	14x2,0 240m	1680	240	$\frac{m}{MO}$	<b>2,89</b>
<b>1088166</b>	14x2,0 640m	1920	640	$\frac{m}{MO}$	<b>2,89</b>
<b>1062885</b>	14x2,0 960m	1920	960	$\frac{m}{MO}$	<b>2,89</b>

## Uponor Vario Klemmringverschraubung PEX

 <b>1065283</b>	14x2,0-G $\frac{3}{4}$ "FT Euro	25	1	$\frac{St.}{MZ}$	<b>6,71</b>
--	---------------------------------	----	---	------------------	-------------

## Uponor Fit Übergangverschraubung PEX

 <b>1065294</b>	14x2,0-R $\frac{1}{2}$ "MT	25	1	$\frac{St.}{MZ}$	<b>16,84</b>
--	----------------------------	----	---	------------------	--------------

## Uponor Fit Übergangverschraubung PEX

 <b>1065295</b>	14x2,0-Rp $\frac{1}{2}$ "FT	25	1	$\frac{St.}{MZ}$	<b>17,55</b>
--	-----------------------------	----	---	------------------	--------------

## Uponor Q&E Kupplung m. Ringen DR

 <b>1058659</b>	14-14	100	10	$\frac{St.}{MZ}$	<b>6,74</b>
--	-------	-----	----	------------------	-------------

## Uponor Q&E Ring natural, eval

 <b>1058428</b>	14	900	20	$\frac{St.}{MZ}$	<b>0,40</b>
--	----	-----	----	------------------	-------------

## Uponor Smart Presskupplung

 <b>1089646</b>	14x2,0-14x2,0	80	20	$\frac{St.}{MZ}$	<b>10,01</b>
--	---------------	----	----	------------------	--------------

Art-Nr.	Dimension	LE	VE	ME RG	Preis/ME
---------	-----------	----	----	----------	----------

## Uponor MLCP RED Rohr

 <b>1096010</b>	14x1,6 240m	3120	240	$\frac{m}{M1}$	<b>1,68</b>
<b>1096011</b>	14x1,6 480m	3360	480	$\frac{m}{M1}$	<b>1,68</b>

## Uponor Vario Eurokonusverschraubung MLCP RED

 <b>1000117</b>	14x1,6- $\frac{3}{4}$ "Euro	80	20	$\frac{St.}{MZ}$	<b>5,79</b>
--	-----------------------------	----	----	------------------	-------------

## Uponor MLCP RED Press-Kupplung

 <b>1048272</b>	14x1,6-14x1,6	80	20	$\frac{St.}{MZ}$	<b>10,72</b>
--	---------------	----	----	------------------	--------------

## Uponor Multi Rohrführungsbogen Kunststoff

 <b>1000118</b>	18	250	50	$\frac{St.}{D1}$	<b>3,09</b>
--	----	-----	----	------------------	-------------

## Uponor Siccus Sport Stahlblechabdeckung

 <b>1085611</b>	26m <sup>2</sup> 0,6X1000X2000mm	-	26	$\frac{m^2}{M^3}$	<b>54,50</b>
<b>1085610</b>	204m <sup>2</sup> 0,6x1000x2000mm	-	204	$\frac{m^2}{M^3}$	<b>42,50</b>

## Uponor Siccus 14 Schneidegerät

 <b>1006290</b>	14mm 230V	20	1	$\frac{St.}{NET}$	<b>241,47</b>
--	-----------	----	---	-------------------	---------------

## Uponor Siccus 14 Schneideinsatz

 <b>1006291</b>	14	-	1	$\frac{St.}{U1}$	<b>216,45</b>
--	----	---	---	------------------	---------------



# Uponor Renovis

Art-Nr.	Dimension	LE	VE	ME RG	Preis/ME
 <b>1061173</b>	800x625mm	-	24	St. MR	<b>94,51</b>
<b>1061172</b>	1200x625mm	-	24	St. MR	<b>127,68</b>
<b>1061171</b>	2000x625mm	-	24	St. MR	<b>143,51</b>

## Uponor Renovis Panel extra

 <b>1063923</b>	800x625x15mm	24	1	St. MR	<b>105,33</b>
<b>1063924</b>	1200x625x15mm	24	1	St. MR	<b>132,57</b>
<b>1063925</b>	2000x625x15mm	24	1	St. MR	<b>159,33</b>

## Uponor Renovis Panel

 <b>1063926</b>	2000x625x15mm	-	24	St. MR	<b>36,49</b>
--	---------------	---	----	-----------	--------------

## Uponor Renovis Anschlusset

 <b>1061165</b>	4-6X	10	1	Set MR	<b>512,04</b>
--	------	----	---	-----------	---------------

## Uponor Fix Klemmschiene

 <b>1005274</b>	9,9mm c/c20mm 2,5m	25	2,5	m M2	<b>5,86</b>
---	--------------------	----	-----	---------	-------------

## Uponor Renovis Klemmschiene

 <b>1061162</b>	20mm l=250mm	-	15	St. MR	<b>5,20</b>
--	--------------	---	----	-----------	-------------

## Uponor Minitec Rohr Comfort Pipe

 <b>1063287</b>	9,9x1,1 60m	840	60	m M2	<b>3,35</b>
<b>1063288</b>	9,9x1,1 120m	1680	120	m M2	<b>3,35</b>

## Uponor Minitec Übergangsnippel

 <b>1005265</b>	9,9-R½"MT	100	10	St. M2	<b>11,19</b>
--	-----------	-----	----	-----------	--------------

## Uponor Minitec Kupplung

 <b>1005264</b>	9,9x1,1	100	10	St. M2	<b>9,12</b>
--	---------	-----	----	-----------	-------------

## Uponor Minitec Ring

 <b>1005263</b>	9,9x1,1	1600	10	St. M2	<b>0,60</b>
--	---------	------	----	-----------	-------------

Art-Nr.	Dimension	LE	VE	ME RG	Preis/ME
 <b>1009229</b>	20x2,0 60m	660	60	m M0	<b>3,08</b>

## Uponor Magna pipe PLUS

 <b>1091275</b>	20x2,0 240m	960	240	m B7	<b>3,04</b>
<b>1091276</b>	20x2,0 480m	960	480	m B7	<b>3,04</b>

## Uponor Minitec T-Stück reduziert Q&E

 <b>1020524</b>	20xMinitec9,9xQ&E20	75	5	St. MZ	<b>13,78</b>
--	---------------------	----	---	-----------	--------------

## Uponor Minitec Kupplung red. Q&E

 <b>1020518</b>	20xMinitec9,9	150	5	St. MZ	<b>15,45</b>
--	---------------	-----	---	-----------	--------------

## Uponor Q&E Kupplung PPSU

 <b>1008932</b>	20-20	80	5	St. F1	<b>5,23</b>
--	-------	----	---	-----------	-------------

## Uponor Q&E Kupplung m. Ringen CE PPSU

 <b>1072005</b>	20-20	30	1	St. F1	<b>6,13</b>
---	-------	----	---	-----------	-------------

## Uponor Q&E Winkel PPSU

 <b>1008680</b>	20-20	40	5	St. F1	<b>6,96</b>
--	-------	----	---	-----------	-------------

## Uponor Q&E Sicherungsring white

 <b>1057454</b>	20	520	20	St. F1	<b>0,57</b>
--	----	-----	----	-----------	-------------

# Uponor Renovis

Art-Nr.	Dimension	LE	VE	ME RG	Preis/ME
---------	-----------	----	----	----------	----------

## Uponor Uni Pipe PLUS weiß S

 <b>1060784</b>	20x2,25 3m	51	3	m E1	<b>7,38</b>
--	------------	----	---	---------	-------------

## Uponor Q&E T-Stück Übergang S-Press

 <b>1063938</b>	20-Q&E9,9-Press20	6	2	St. D1	<b>13,32</b>
--	-------------------	---	---	-----------	--------------

## Uponor Q&E Übergang S-Press

 <b>1063939</b>	20-Q&E9,9	12	2	St. D1	<b>10,65</b>
--	-----------	----	---	-----------	--------------

## Uponor Vario VL-Feinregulierventil

 <b>1005107</b>	1/2" - G3/4	50	1	St. MZ	<b>29,84</b>
--	-------------	----	---	-----------	--------------

## Uponor Vario RL-Ventil

 <b>1005108</b>	1/2" - G3/4	50	1	St. MZ	<b>29,05</b>
--	-------------	----	---	-----------	--------------

## Uponor Vario PLUS Thermoantrieb NC

 <b>1005605</b>	230V MT30x1,5	10	1	St. MZ	<b>70,09</b>
--	---------------	----	---	-----------	--------------

## Uponor Base Raumfühler T-23

 <b>1058422</b>	230V RAL9010	160	1	St. MZ	<b>48,77</b>
--	--------------	-----	---	-----------	--------------

Art-Nr.	Dimension	LE	VE	ME RG	Preis/ME
---------	-----------	----	----	----------	----------

## Uponor Minitec Aufweitwerkzeug

 <b>1006247</b>	9,9x1,1	11	1	Set NET	<b>345,97</b>
--	---------	----	---	------------	---------------

## Uponor Q&E Aufweitwerkzeug mit Aufweitk. M12

 <b>1063112</b>	6BAR 9,9/20	-	1	Set NET	<b>585,05</b>
--	-------------	---	---	------------	---------------

## Uponor Q&E Aufweitwerkzeug mit Aufweitk. M12/

 <b>NEU</b> <b>1119375</b>	6bar 9,9RS/20	-	1	Set NET	<b>608,00</b>
	<b>NEU</b> ab 01.06.2022				

## Uponor Multi Umlenkbogen, Kunststoff

 <b>1063781</b>	12	500	50	St. M2	<b>1,21</b>
--	----	-----	----	-----------	-------------

# Uponor Siccus wall

Art-Nr.	Dimension	LE	VE	ME RG	Preis/ME
---------	-----------	----	----	----------	----------

## Uponor Siccus 14 Verlegeplatte

 <b>1005485</b>	EPS 150kPa 14mm 1197x1050x25mm	100	12,5	$\frac{m^2}{M^3}$	<b>18,13</b>
--	-----------------------------------	-----	------	-------------------	--------------

## Uponor Siccus 14 Wärmeleitlamelle

 <b>1005486</b>	14mm 1180x120x0,45mm	768	48	$\frac{St.}{M^3}$	<b>6,38</b>
--	----------------------	-----	----	-------------------	-------------

## Uponor Comfort Pipe PLUS Rohr

 <b>1062883</b>	14x2,0 120m	1320	120	$\frac{m}{MO}$	<b>2,89</b>
<b>1062884</b>	14x2,0 240m	1680	240	$\frac{m}{MO}$	<b>2,89</b>
<b>1062885</b>	14x2,0 960m	1920	960	$\frac{m}{MO}$	<b>2,89</b>

## Uponor Vario Klemmringverschraubung PEX

 <b>1065283</b>	14x2,0-G $\frac{3}{4}$ "FT Euro	25	1	$\frac{St.}{MZ}$	<b>6,71</b>
--	---------------------------------	----	---	------------------	-------------

## Uponor Fit Übergangverschraubung PEX

 <b>1065294</b>	14x2,0-R $\frac{1}{2}$ "MT	25	1	$\frac{St.}{MZ}$	<b>16,84</b>
--	----------------------------	----	---	------------------	--------------

## Uponor Fit Übergangverschraubung PEX

 <b>1065295</b>	14x2,0-Rp $\frac{1}{2}$ "FT	25	1	$\frac{St.}{MZ}$	<b>17,55</b>
--	-----------------------------	----	---	------------------	--------------

## Uponor Q&E Kupplung m. Ringen DR

 <b>1058659</b>	14-14	100	10	$\frac{St.}{MZ}$	<b>6,74</b>
--	-------	-----	----	------------------	-------------

## Uponor Q&E Ring natural, eval

 <b>1058428</b>	14	900	20	$\frac{St.}{MZ}$	<b>0,40</b>
--	----	-----	----	------------------	-------------

## Uponor Smart Presskupplung

 <b>1089646</b>	14x2,0-14x2,0	80	20	$\frac{St.}{MZ}$	<b>10,01</b>
--	---------------	----	----	------------------	--------------

## Uponor MLCP RED Rohr

 <b>1096010</b>	14x1,6 240m	3120	240	$\frac{m}{M1}$	<b>1,68</b>
<b>1096011</b>	14x1,6 480m	3360	480	$\frac{m}{M1}$	<b>1,68</b>

## Uponor Vario Eurokonusverschraubung MLCP RED

 <b>1000117</b>	14x1,6- $\frac{3}{4}$ "Euro	80	20	$\frac{St.}{MZ}$	<b>5,79</b>
--	-----------------------------	----	----	------------------	-------------

## Uponor MLCP RED Press-Kupplung

 <b>1048272</b>	14x1,6-14x1,6	80	20	$\frac{St.}{MZ}$	<b>10,72</b>
--	---------------	----	----	------------------	--------------

## Uponor Siccus 14 Schneidegerät

 <b>1006290</b>	14mm 230V	20	1	$\frac{St.}{NET}$	<b>241,47</b>
--	-----------	----	---	-------------------	---------------

# Uponor Siccus SW

Art-Nr.	Dimension	LE	VE	ME RG	Preis/ME
---------	-----------	----	----	----------	----------

## Uponor Siccus SW Ständerwandelement

 <b>1005499</b>	14mm 1150x615mm	56,6	2,83	$\frac{m^2}{M^3}$	<b>135,00</b>
--	-----------------	------	------	-------------------	---------------

 Lieferung solange Vorrat reicht. Artikel läuft im Laufe des Jahres aus.

## Uponor Comfort Pipe PLUS Rohr

 <b>1062883</b>	14x2,0 120m	1320	120	$\frac{m}{MO}$	<b>2,89</b>
<b>1062884</b>	14x2,0 240m	1680	240	$\frac{m}{MO}$	<b>2,89</b>

## Uponor Vario Klemmringverschraubung PEX

 <b>1065283</b>	14x2,0-G $\frac{3}{4}$ "FT Euro	25	1	$\frac{St.}{MZ}$	<b>6,71</b>
--	---------------------------------	----	---	------------------	-------------

## Uponor Fit Übergangverschraubung PEX

 <b>1065294</b>	14x2,0-R $\frac{1}{2}$ "MT	25	1	$\frac{St.}{MZ}$	<b>16,84</b>
--	----------------------------	----	---	------------------	--------------

## Uponor Fit Übergangverschraubung PEX

 <b>1065295</b>	14x2,0-Rp $\frac{1}{2}$ "FT	25	1	$\frac{St.}{MZ}$	<b>17,55</b>
--	-----------------------------	----	---	------------------	--------------

## Uponor Q&E Kupplung m. Ringen DR

 <b>1058659</b>	14-14	100	10	$\frac{St.}{MZ}$	<b>6,74</b>
--	-------	-----	----	------------------	-------------

## Uponor Q&E Ring natural, eval

 <b>1058428</b>	14	900	20	$\frac{St.}{MZ}$	<b>0,40</b>
--	----	-----	----	------------------	-------------

# Uponor Thermanop Deckensystem

Art-Nr.	Dimension	LE	VE	ME RG	Preis/ME
---------	-----------	----	----	----------	----------

## Uponor Thermanop M



1090933	950x277mm	200	10	St. 16	60,53
1090934	1350x277mm	200	10	St. 16	85,08
1090935	1750x277mm	200	10	St. 16	109,63
1090936	2150x277mm	200	10	St. 16	137,31
1090937	2550x277mm	200	10	St. 16	161,49

**b = Breite aktive Fläche**

**Verbindungstechnik: S-Press PLUS oder RTM**

Verbindungstechnik: die einzelnen Module können mit der üblichen Uponor-Verbindungstechnologie S-Press oder RTM verbunden werden

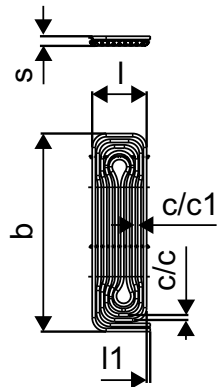

Art-Nr.	Dimension	LE	VE	ME RG	Preis/ME
---------	-----------	----	----	----------	----------

## Uponor Uni-X Verschraubung MLC

 1058090	16-3/4" FT Euro	25	1	St.	7,50
---	-----------------	----	---	-----	------

## Uponor S-Press PLUS Kupplung

 1070547	16-16	80	10	St.	9,59
---	-------	----	----	-----	------

## Uponor S-Press PLUS Kupplung PPSU

 1039933	16-16	80	10	St.	6,03
---	-------	----	----	-----	------



# Uponor Multi Zubehör Fußbodenaufbau

INHALT

Installation

Flächenheizung  
und -kühlungNahwärme-  
versorgung

Werkzeuge

Anhang

Art-Nr.	Dimension	LE	VE	ME RG	Preis/ME
---------	-----------	----	----	----------	----------

## Uponor Multi Rohrbinder PA

 <b>1005372</b>	300mm	5000	100	St. B7	<b>0,30</b>
Hinweis: Verkauf pro Verpackungseinheit.					

## Uponor Multi Rohrbinder PA

 <b>1086531</b>	200mm	10000	100	St. B7	<b>0,20</b>
Hinweis: Verkauf pro Verpackungseinheit.					

## Uponor Multi Klemmschiene

 <b>1005358</b>	20mm c/c50mm 3m	30	3	m B3	<b>8,52</b>
--	-----------------	----	---	---------	-------------

## Uponor Multi Dampfsperre PE

 <b>1005069</b>	3/300 3,3mm 40x1,25m	250	50	m <sup>2</sup> MZ	<b>10,17</b>
Hinweis: Verkauf pro Verpackungseinheit von 1 Rolle = 50 m <sup>2</sup>					

## Uponor Multi Dicht- und Kleband PE 3/300

 <b>1005071</b>	15m	8	1	St. MZ	<b>66,03</b>
--	-----	---	---	-----------	--------------

## Uponor Multi Folie PE

 <b>1005051</b>	0,1mm 75x2m	6900	150	m <sup>2</sup> MZ	<b>1,18</b>
Hinweis: Verkauf pro Verpackungseinheit von 1 Rolle					

## Uponor Multi Folie PE

 <b>1005049</b>	0,2mm 60x1,25m	3375	75	m <sup>2</sup> MZ	<b>1,80</b>
Hinweis: Verkauf pro Verpackungseinheit.					

## Uponor Multi Folie

 <b>1000017</b>	4mm 60x1m	-	60	m <sup>2</sup> MZ	<b>8,86</b>
--	-----------	---	----	----------------------	-------------

## Uponor Multi Rasterfolie

 <b>1000015</b>	0,25mm 100x1,03m	2472	103	m <sup>2</sup> M8	<b>3,51</b>
--	------------------	------	-----	----------------------	-------------

## Uponor Multi Foliendübel

 <b>1000016</b>	l=25mm	5000	100	St. MZ	<b>0,34</b>
Hinweis: Verkauf pro Verpackungseinheit.					

Art-Nr.	Dimension	LE	VE	ME RG	Preis/ME
---------	-----------	----	----	----------	----------

## Uponor Multi Randdämmstreifen Klebefolie

 <b>1000080</b>	150x10mm	-	200	m MZ	<b>2,62</b>
Hinweis: Verkauf pro Verpackungseinheit.					

## Uponor Multi Randdämmstreifen mit Folie

 <b>1000079</b>	150x8mm	-	200	m MZ	<b>1,29</b>
Hinweis: Verkauf pro Verpackungseinheit.					

## Uponor Multi Dehnungsfugenprofil

 <b>1090229</b>	1800x100x10mm	720	18	m MZ	<b>12,04</b>
--	---------------	-----	----	---------	--------------

## Uponor Multi Klebeband

 <b>1000012</b>	66m 50mm	36	1	St. MZ	<b>6,19</b>
--	----------	----	---	-----------	-------------

## Uponor Multi Schutzhülse

 <b>1000082</b>	20mm 300x5mm	10800	30	St. MZ	<b>1,17</b>
--	--------------	-------	----	-----------	-------------

## Uponor Multi Estrichkomponente VD 450

 <b>1000084</b>	20L	480	20	l MZ	<b>5,86</b>
Hinweis: Vor Frost und UV - Strahlung schützen. Rücknahme ausgeschlossen.					

## Uponor Multi Estrichkomponente VD 550 N

 <b>1000085</b>	25L	600	25	l MZ	<b>11,50</b>
Hinweis: Vor Frost und UV - Strahlung schützen. Rücknahme ausgeschlossen.					

## Uponor Multi Messstellenmarkierung

 <b>1000083</b>	100mm	-	10	St. MZ	<b>6,71</b>
--	-------	---	----	-----------	-------------

## Uponor Multi Gebundene Schüttung

 <b>1000052</b>	100l	2500	100	l C1	<b>1,34</b>
Hinweis: Verkauf pro Verpackungseinheit von 1 Sack = 100 l					

## Uponor Multi Frostschutzmittel

 <b>1005066</b>	≥ -30C 20l	480	20	l MZ	<b>19,42</b>
--	------------	-----	----	---------	--------------

# Verteil und Steigleitungen > 20mm

Art-Nr.	Dimension	LE	VE	ME RG	Preis/ME
 <b>1060785</b>	25x2,5 3m	30	3	m E1	<b>12,52</b>
<b>1060786</b>	32x3,0 3m	21	3	m E1	<b>17,91</b>

## Uponor MLC Rohr weiß S

 <b>1013448</b>	40x4,0 3m	12	3	m E1	<b>33,36</b>
<b>1021980</b>	50x4,5 3m	12	3	m E1	<b>47,30</b>
<b>1021981</b>	63x6,0 3m	9	3	m E1	<b>59,99</b>
<b>1013453</b>	75x7,5 5m	255	5	m E1	<b>94,78</b>

## Uponor S-Press PLUS Kupplung PPSU

 <b>1039935</b>	25-25	80	10	St. E1	<b>12,21</b>
<b>1039936</b>	32-32	80	10	St. E1	<b>17,94</b>

## Uponor S-Press Verbund Kupplung PPSU

 <b>1046401</b>	40-40	960	5	St. E1	<b>34,67</b>
<b>1046402</b>	50-50	576	3	St. E1	<b>45,94</b>
<b>1032881</b>	63-63	384	1	St. E1	<b>86,14</b>
<b>1032882</b>	75-75	384	1	St. E1	<b>139,37</b>

## Uponor S-Press PLUS Kupplung reduziert PPSU

 <b>1039940</b>	32-25	80	10	St. E1	<b>18,35</b>
<b>1039941</b>	40-25	960	5	St. E1	<b>32,38</b>
<b>1039942</b>	40-32	960	5	St. E1	<b>32,38</b>
<b>1039943</b>	50-32	1152	3	St. E1	<b>42,19</b>

## Uponor S-Press Verbund Kupplung red. PPSU

 <b>1046406</b>	50-40	576	3	St. E1	<b>46,39</b>
<b>1032883</b>	63-40	384	1	St. E1	<b>79,99</b>
<b>1032884</b>	63-50	384	1	St. E1	<b>81,69</b>
<b>1032885</b>	75-50	384	1	St. E1	<b>117,54</b>
<b>1032886</b>	75-63	384	1	St. E1	<b>129,99</b>

## Uponor S-Press PLUS Winkel PPSU

 <b>1039931</b>	25-25	80	10	St. E1	<b>17,59</b>
<b>1039932</b>	32-32	20	5	St. E1	<b>24,21</b>

## Uponor S-Press Verbund Winkel PPSU

 <b>1046386</b>	40-40	960	5	St. E1	<b>49,57</b>
<b>1046387</b>	50-50	576	3	St. E1	<b>63,86</b>
<b>1032877</b>	63-63	210	1	St. E1	<b>118,17</b>
<b>1032878</b>	75-75	210	1	St. E1	<b>181,51</b>

## Uponor S-Press Verbund Winkel 45° PPSU

 <b>1046388</b>	40-40	960	5	St. E1	<b>49,54</b>
<b>1046389</b>	50-50	576	3	St. E1	<b>67,96</b>
<b>1032879</b>	63-63	192	1	St. E1	<b>124,66</b>
<b>1032880</b>	75-75	192	1	St. E1	<b>169,59</b>

Art-Nr.	Dimension	LE	VE	ME RG	Preis/ME
 <b>1039946</b>	25-25-25	20	5	St. E1	<b>19,99</b>
<b>1039947</b>	32-32-32	20	5	St. E1	<b>32,82</b>

## Uponor S-Press Verbund T-Stück PPSU

 <b>1046390</b>	40-40-40	720	5	St. E1	<b>71,44</b>
<b>1046391</b>	50-50-50	288	3	St. E1	<b>84,49</b>
<b>1032887</b>	63-63-63	150	1	St. E1	<b>150,30</b>
<b>1032888</b>	75-75-75	150	1	St. E1	<b>236,88</b>

## Uponor S-Press PLUS T-Stück m. Innengew.

 <b>1070598</b>	25-Rp1/2"FT-25	20	5	St. E1	<b>37,59</b>
<b>1070600</b>	32-Rp1/2"FT-32	20	5	St. E1	<b>53,86</b>

## Uponor S-Press T-Stück mit Innengewinde

 <b>1046922</b>	40-Rp1/2"FT-40	500	5	St. E1	<b>62,66</b>
<b>1046929</b>	50-Rp1"FT-50	240	3	St. E1	<b>104,22</b>

## Uponor S-Press PLUS Übergangsnippel

 <b>1070507</b>	25-R3/4"MT	80	10	St. E1	<b>19,40</b>
<b>1070508</b>	25-R1"MT	40	5	St. E1	<b>22,92</b>
<b>1070509</b>	32-R1"MT	40	5	St. E1	<b>25,23</b>
<b>1070510</b>	32-R1 1/4"MT	20	5	St. E1	<b>32,70</b>

## Uponor S-Press Übergangsnippel

 <b>1046901</b>	40-R1 1/4"MT	960	5	St. E1	<b>40,86</b>
<b>1046902</b>	40-R1 1/2"MT	960	5	St. E1	<b>45,18</b>
<b>1046905</b>	50-R1 1/2"MT	1152	3	St. E1	<b>67,79</b>
<b>1046906</b>	50-R2"MT	576	3	St. E1	<b>87,11</b>
<b>1032895</b>	63-R2"MT	336	1	St. E1	<b>123,68</b>
<b>1032896</b>	75-R2 1/2"MT	336	1	St. E1	<b>163,05</b>

## Uponor S-Press PLUS Übergangsmuffe















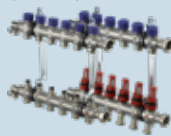

 <b>1070519</b>	25-Rp3/4"FT	40	5	St. E1	<b>22,56</b>
<b>1070520</b>	25-Rp1"FT	40	5	St. E1	<b>23,75</b>
<b>1070521</b>	32-Rp1"FT	40	5	St. E1	<b>27,61</b>
<b>1070522</b>	32-Rp1 1/4"FT	20	5	St. E1	<b>34,07</b>

## Uponor S-Press Übergangsmuffe

 <b>1046903</b>	40-Rp1 1/4"FT	960	5	St. E1	<b>42,51</b>
<b>1046904</b>	40-Rp1 1/2"FT	960	5	St. E1	<b>42,96</b>
<b>1046907</b>	50-Rp1 1/2"FT	1152	3	St. E1	<b>103,59</b>



# Übersicht Uponor Stellantriebe DE

Stellantrieb		Passend für Verteiler			Siehe Seite	
<b>Uponor Vario PLUS</b> Thermoantrieb PRO MT 30x1,5 		Uponor Vario PLUS 	Uponor Magna Industrieheizungs- verteiler 	Uponor Vario Regulierventil 	Uponor Vario RL-Ventil 	
Typ	Art.-Nr.	Preis/ME				
24 V	1000138	70,09			40	
230 V	1005605	70,09			40, 34, 50	
<b>Uponor Vario Thermoantrieb S</b> FT 30x1,5 		Vario S Edelstahl- verteiler ST FM und LS 	Vario M mit Durch- flussmesser FM 	Comfort Port vormontierte Verteilerstationen 	Vario S Edelstahl- verteiler ST LS und FM (bis 2018) 	Ersatzteil Chrona- therm
Typ	Art.-Nr.	Preis/ME				
24 V	1013008	37,34			42	
230 V	1013006	37,34			42, 50	
<b>Uponor Vario B Thermoantrieb PRO</b> FT 28x1,5 		Ersatzteil Uponor Fluvia T 	Ersatzteil Unipipe 			
Typ	Art.-Nr.	Preis/ME				
24 V	1007249	70,09				
230 V	1022244	70,09				
<b>Uponor Vario PLUS Adapter VA 02</b> 30 x 1,5 AG 		Ersatzteil Velta Kompakt und Velta Euro-Verteiler 				
Typ	Art.-Nr.	Preis/ME				
24 V	1090262	70,09				
230 V	1090263	70,09				
<b>Uponor Vario B Adapter VA 32</b> 28 x 1,5 IG 		Ersatzteil Polytherm ohne DF 	Ersatzteil Polytherm DF 			
Typ	Art.-Nr.	Preis/ME				
24 V	1090264	70,09				
230 V	1090265	70,09				

# Uponor Vario PLUS

Art-Nr.	Dimension	LE	VE	ME RG	Preis/ME
---------	-----------	----	----	----------	----------

## Uponor Vario PLUS Verteiler mit Ventil

 <b>1042420</b>	LS 1X ¾ Euro	10	1	Paar MZ	<b>65,90</b>
<b>1030580</b>	LS 3X ¾ Euro	290	1	Paar MZ	<b>160,52</b>
<b>1030581</b>	LS 4X ¾ Euro	225	1	Paar MZ	<b>201,31</b>
<b>1030582</b>	LS 6X ¾ Euro	155	1	Paar MZ	<b>285,19</b>

## Uponor Vario PLUS Verteiler m. Durchflm.

 <b>1042471</b>	FM 1X ¾ Euro	10	1	Paar MZ	<b>81,37</b>
<b>1030583</b>	FM 3X ¾ Euro	174	1	Paar MZ	<b>185,70</b>
<b>1030584</b>	FM 4X ¾ Euro	135	1	Paar MZ	<b>242,04</b>
<b>1030585</b>	FM 6X ¾ Euro	93	1	Paar MZ	<b>351,07</b>

## Uponor Vario PLUS Verteiler Basis Set

 <b>1009209</b>	K1	248	1	St. MZ	<b>126,98</b>
--	----	-----	---	-----------	---------------

## Uponor Vario PLUS Thermoantrieb NC

 <b>1000138</b>	24V MT30x1,5	10	1	St. MZ	<b>70,09</b>
<b>1005605</b>	230V MT30x1,5	10	1	St. MZ	<b>70,09</b>

## Uponor Vario PLUS Stellantrieb 100kOhm

 <b>1005544</b>	24V NC MT30x1,5 0-10V DC	100	1	St. MZ	<b>180,90</b>
--	--------------------------	-----	---	-----------	---------------

## Uponor Vario Klemmringverschraubung PEX

 <b>1065283</b>	14x2,0-G¾"FT Euro	25	1	St. MZ	<b>6,71</b>
<b>1065284</b>	16x1,8/2,0-G¾"FT Euro	25	1	St. MZ	<b>6,71</b>
<b>1065286</b>	17x2,0-G¾"FT Euro	25	1	St. MZ	<b>6,71</b>
<b>1065290</b>	20x1,9/2,0-G¾"FT Euro	25	1	St. MZ	<b>7,01</b>

## Uponor Vario PLUS Winkelset

 <b>1032702</b>	122/42	5	1	Paar MZ	<b>30,56</b>
--	--------	---	---	------------	--------------

## Uponor Vario PLUS Verteileranschlussset

 <b>1005227</b>		10	1	Set U1	<b>67,38</b>
--	--	----	---	-----------	--------------

## Uponor Vario PLUS Schlauchtülle

 <b>1009214</b>	G¾ x ½	10	1	St. MZ	<b>3,04</b>
--	--------	----	---	-----------	-------------

Art-Nr.	Dimension	LE	VE	ME RG	Preis/ME
---------	-----------	----	----	----------	----------

## Uponor Vario PLUS Distanzringset

 <b>1009215</b>		10	1	St. MZ	<b>11,14</b>
--	--	----	---	-----------	--------------

## Uponor Vario PLUS Dämmset

 <b>1063207</b>		-	1	Set MZ	<b>106,29</b>
--	--	---	---	-----------	---------------

## Uponor Vario Bezeichnungsschilder

 <b>1005063</b>	47x10mm	-	1	Set MZ	<b>33,06</b>
--	---------	---	---	-----------	--------------

## Uponor Vario PLUS Thermometer 0-60°C

 <b>1034524</b>	D=40mm	20	1	Paar U1	<b>22,43</b>
--	--------	----	---	------------	--------------

## Uponor Vario PLUS Durchflussmesser

 <b>1009217</b>	4 l/min	20	1	St. MZ	<b>17,55</b>
--	---------	----	---	-----------	--------------

## Uponor Vario PLUS Vorlauf-Ventileinsatz scale 1-5

 <b>1034523</b>		-	20	St. U1	<b>16,67</b>
---	--	---	----	-----------	--------------

## Uponor Vario PLUS Rücklaufventileinsatz

 <b>1005250</b>		10	1	St. U1	<b>14,72</b>
--	--	----	---	-----------	--------------

## Uponor Vario Rücklauf-Ventileinsatz

 <b>1005099</b>		10	1	St. U1	<b>32,35</b>
--	--	----	---	-----------	--------------

## Uponor Vario Vorlaufventil-Handrad, weiß

 <b>1005101</b>		-	1	St. U1	<b>2,65</b>
--	--	---	---	-----------	-------------

## Uponor Vario Vorlaufventileinsatz

 <b>1005098</b>		-	1	St. U1	<b>31,83</b>
--	--	---	---	-----------	--------------



# Uponor Vario M

Art-Nr.	Dimension	LE	VE	ME RG	Preis/ME
<b>Uponor Vario M Verteiler mit Durchflußmesser FM</b>					
 <b>1085944</b>	2X G¾ Euro	80	1	St. MZ	<b>195,28</b>
<b>1085945</b>	3X G¾ Euro	80	1	St. MZ	<b>251,64</b>
<b>1085946</b>	4X G¾ Euro	80	1	St. MZ	<b>309,15</b>
<b>1085947</b>	5X G¾ Euro	80	1	St. MZ	<b>366,64</b>
<b>1085948</b>	6X G¾ Euro	80	1	St. MZ	<b>416,97</b>
<b>1085949</b>	7X G¾ Euro	80	1	St. MZ	<b>472,10</b>
<b>1085950</b>	8X G¾ Euro	80	1	St. MZ	<b>529,59</b>
<b>1085951</b>	9X G¾ Euro	80	1	St. MZ	<b>584,74</b>
<b>1085952</b>	10X G¾ Euro	80	1	St. MZ	<b>646,87</b>
<b>1086250</b>	11X G¾ Euro	108	1	St. MZ	<b>718,75</b>
<b>1086251</b>	12X G¾ Euro	108	1	St. MZ	<b>772,89</b>
<b>1087129</b>	13X G¾ Euro	30	1	St. MZ	<b>928,58</b>
<b>1087130</b>	14X G¾ Euro	30	1	St. MZ	<b>976,41</b>
<b>1087131</b>	15X G¾ Euro	30	1	St. MZ	<b>1018,49</b>

Art-Nr.	Dimension	LE	VE	ME RG	Preis/ME
<b>Uponor Vario M Verteiler - Durchflussmesser</b>					
 <b>NEU</b> <b>1121531</b>	0-5l/min	10	1	St. U1	<b>7,50</b>

## Uponor Vario M Durchflussanzeige

 <b>OUT</b> <b>1085956</b>	0-5l/min	-	1	St. U1	<b>13,31</b>
---	----------	---	---	-----------	--------------

Lieferung solange Vorrat reicht. Artikel läuft im Laufe des Jahres aus.

## Uponor Vario M Halterung

 <b>1087531</b>		-	1	Set U1	<b>22,26</b>
--	--	---	---	-----------	--------------

## Uponor Vario M Füll- und Entleerungsventil

 <b>NEU</b> <b>1120810</b>		10	1	St. U1	<b>73,00</b>
---	--	----	---	-----------	--------------

## Uponor Vario Bezeichnungsschilder

 <b>1005063</b>	47x10mm	-	1	Set MZ	<b>33,06</b>
--	---------	---	---	-----------	--------------

# Uponor Vario S

Art-Nr.	Dimension	LE	VE	ME RG	Preis/ME
---------	-----------	----	----	----------	----------

## Uponor Vario S-Verteiler FM

	<b>1086538</b> 2X $\frac{3}{4}$ Euro	108	1	St. MZ	<b>147,39</b>
	<b>1086539</b> 3x $\frac{3}{4}$ Euro	108	1	St. MZ	<b>190,51</b>
	<b>1086540</b> 4x $\frac{3}{4}$ Euro	108	1	St. MZ	<b>234,84</b>
	<b>1086541</b> 5x $\frac{3}{4}$ Euro	108	1	St. MZ	<b>276,78</b>
	<b>1086542</b> 6x $\frac{3}{4}$ Euro	72	1	St. MZ	<b>319,93</b>
	<b>1086543</b> 7X $\frac{3}{4}$ Euro	72	1	St. MZ	<b>361,85</b>
	<b>1086544</b> 8x $\frac{3}{4}$ Euro	72	1	St. MZ	<b>406,20</b>
	<b>1086545</b> 9x $\frac{3}{4}$ Euro	72	1	St. MZ	<b>450,54</b>
	<b>1086546</b> 10x $\frac{3}{4}$ Euro	48	1	St. MZ	<b>494,87</b>
	<b>1086547</b> 11x $\frac{3}{4}$ Euro	48	1	St. MZ	<b>539,21</b>
	<b>1086548</b> 12x $\frac{3}{4}$ Euro	48	1	St. MZ	<b>583,55</b>
	<b>1088864</b> 13x $\frac{3}{4}$ Euro	48	1	St. MZ	<b>641,05</b>
	<b>1088865</b> 14X $\frac{3}{4}$ Euro	36	1	St. MZ	<b>688,84</b>
	<b>1088866</b> 15x $\frac{3}{4}$ Euro	36	1	St. MZ	<b>736,88</b>
	<b>1088867</b> 16x $\frac{3}{4}$ Euro	36	1	St. MZ	<b>778,66</b>

## Uponor Vario S Verteiler LS

	<b>1088045</b> 2X $\frac{3}{4}$ Euro	108	1	St. MZ	<b>137,77</b>
	<b>1088046</b> 3X $\frac{3}{4}$ Euro	108	1	St. MZ	<b>171,34</b>
	<b>1088047</b> 4X $\frac{3}{4}$ Euro	108	1	St. MZ	<b>196,52</b>
	<b>1088048</b> 5X $\frac{3}{4}$ Euro	108	1	St. MZ	<b>222,84</b>
	<b>1088049</b> 6X $\frac{3}{4}$ Euro	72	1	St. MZ	<b>254,02</b>
	<b>1088050</b> 7X $\frac{3}{4}$ Euro	72	1	St. MZ	<b>281,59</b>
	<b>1088051</b> 8X $\frac{3}{4}$ Euro	72	1	St. MZ	<b>311,51</b>
	<b>1088052</b> 9X $\frac{3}{4}$ Euro	72	1	St. MZ	<b>340,29</b>
	<b>1088053</b> 10X $\frac{3}{4}$ Euro	48	1	St. MZ	<b>375,02</b>
	<b>1088054</b> 11X $\frac{3}{4}$ Euro	48	1	St. MZ	<b>403,79</b>
	<b>1088055</b> 12x $\frac{3}{4}$ Euro	48	1	St. MZ	<b>431,36</b>
	<b>1088868</b> 13x $\frac{3}{4}$ Euro	48	1	St. MZ	<b>564,39</b>
	<b>1088869</b> 14x $\frac{3}{4}$ Euro	36	1	St. MZ	<b>605,00</b>
	<b>1088870</b> 15X $\frac{3}{4}$ Euro	36	1	St. MZ	<b>653,05</b>
	<b>1088871</b> 16X $\frac{3}{4}$ Euro	36	1	St. MZ	<b>760,79</b>

## Uponor Vario S Thermoantrieb Edelstahlv. NC

	<b>1013008</b> 24V FT30x1,5	10	1	St. MZ	<b>37,34</b>
	<b>1013006</b> 230V FT30x1,5	10	1	St. MZ	<b>37,34</b>

## Uponor Vario Bezeichnungsschilder

	<b>1005063</b> 47x10mm	-	1	Set MZ	<b>33,06</b>
---	------------------------	---	---	-----------	--------------

## Uponor Vario Regulierventil

	<b>1005100</b> G1 - Rp1	10	1	Set MZ	<b>105,00</b>
---	-------------------------	----	---	-----------	---------------

## Uponor Vario Kugelhahn

	<b>1059132</b> NP G1-G1	10	1	Set D1	<b>37,80</b>
---	-------------------------	----	---	-----------	--------------

Art-Nr.	Dimension	LE	VE	ME RG	Preis/ME
---------	-----------	----	----	----------	----------

## Uponor Vario Kugelhahn

	<b>1086558</b> $\frac{3}{4}$ -G1	10	1	Set MZ	<b>34,50</b>
---	----------------------------------	----	---	-----------	--------------

## Uponor Vario Eck-Kugelhahn

	<b>1086559</b> Rp $\frac{3}{4}$ " - G1"	-	1	Set MZ	<b>68,30</b>
	<b>1090732</b> G1-Rp1	260	1	Set D1	<b>60,92</b>

## Uponor Vario Anschlussstück

	<b>1058573</b> G1-G1A	30	1	St. MZ	<b>23,37</b>
---	-----------------------	----	---	-----------	--------------

## Uponor Vario VL-Feinregulierventil

	<b>1005107</b> $\frac{1}{2}$ " - G $\frac{3}{4}$ "	50	1	St. MZ	<b>29,84</b>
---	--	----	---	-----------	--------------

## Uponor Vario RL-Ventil

	<b>1005108</b> $\frac{1}{2}$ " - G $\frac{3}{4}$ "	50	1	St. MZ	<b>29,05</b>
---	--	----	---	-----------	--------------

## Uponor Vario WMZ - Anschlussset horizontal

	<b>1090730</b> G $\frac{3}{4}$ " 110mm	250	1	Set D1	<b>127,29</b>
	<b>1090728</b> G1" 130mm	-	1	Set D1	<b>199,05</b>

## Uponor Vario WMZ - Anschlussset vertikal

	<b>1090731</b> G $\frac{3}{4}$ " 110mm	250	1	Set D1	<b>186,33</b>
	<b>1090729</b> G1" 130mm	250	1	Set D1	<b>207,09</b>

## Uponor Aqua PLUS Verteilerkappe m. Dichtung

	<b>1001337</b> $\frac{3}{4}$ "FT	250	10	St. F1	<b>5,88</b>
---	----------------------------------	-----	----	-----------	-------------

## Uponor Vario S-Thermometer

	<b>1086537</b>	10	1	Set U1	<b>30,10</b>
---	----------------	----	---	-----------	--------------

## Uponor Vario S Verteiler Kappenventil LS

	<b>1088056</b>	-	10	St. U1	<b>7,72</b>
---	----------------	---	----	-----------	-------------

## Uponor Vario S Verteiler Durchflussmesser

	<b>1087608</b>	-	10	St. U1	<b>18,18</b>
---	----------------	---	----	-----------	--------------

# Uponor Vario

Art-Nr.	Dimension	LE	VE	ME RG	Preis/ME
 <b>1093491</b>	550x730x110mm	18	1	St. MZ	<b>105,20</b>
<b>1093492</b>	700x730x110mm	16	1	St. MZ	<b>119,30</b>
<b>1093493</b>	850x730x110mm	13	1	St. MZ	<b>129,90</b>
<b>1093494</b>	1000x730x110mm	12	1	St. MZ	<b>150,50</b>
<b>1093495</b>	1150x730x110mm	8	1	St. MZ	<b>170,00</b>
<b>1093496</b>	1300x730x110mm	8	1	St. MZ	<b>180,00</b>

## Uponor Vario Verteilerschrank IW

 <b>1093497</b>	550x730x80mm	28	1	St. MZ	<b>99,00</b>
<b>1093498</b>	700x730x80mm	25	1	St. MZ	<b>114,50</b>
<b>1093499</b>	850x730x80mm	19	1	St. MZ	<b>128,50</b>
<b>1093500</b>	1000x730x80mm	18	1	St. MZ	<b>146,20</b>
<b>1093501</b>	1150x730x80mm	12	1	St. MZ	<b>171,00</b>
<b>1093502</b>	1300x730x80mm	12	1	St. MZ	<b>180,00</b>

## Uponor Vario Schrank Rahmen/Tür IW S

 <b>1093528</b>	550x730mm	35	1	St. MZ	<b>108,62</b>
<b>1093541</b>	700x730mm	30	1	St. MZ	<b>130,61</b>
<b>1093542</b>	850x730mm	25	1	St. MZ	<b>147,36</b>
<b>1093543</b>	1000x730mm	20	1	St. MZ	<b>173,72</b>
<b>1093544</b>	1150x730mm	15	1	St. MZ	<b>200,07</b>
<b>1093546</b>	1300x730mm	15	1	St. MZ	<b>231,23</b>

## Uponor Vario Schrank Rahmen/Tür IW P

 <b>1093547</b>	550x730mm	35	1	St. MZ	<b>290,00</b>
<b>1093548</b>	700x730mm	30	1	St. MZ	<b>360,00</b>
<b>1093549</b>	850x730mm	25	1	St. MZ	<b>430,00</b>
<b>1093550</b>	1000x730mm	20	1	St. MZ	<b>460,00</b>
<b>1093551</b>	1150x730mm	15	1	St. MZ	<b>530,00</b>
<b>1093552</b>	1300x730mm	15	1	St. MZ	<b>499,00</b>

## Uponor Vario Zylinderschloss 2 Schlüssel

 <b>1093554</b>		200	1	St. U1	<b>49,26</b>
--	--	-----	---	-----------	--------------

## Uponor Vario Schiene

 <b>1093555</b>		200	1	St. U1	<b>11,37</b>
--	--	-----	---	-----------	--------------

Art-Nr.	Dimension	LE	VE	ME RG	Preis/ME
---------	-----------	----	----	----------	----------

## Uponor Vario Halterungsset

 <b>1093522</b> (5pcs)		200	1	St. U1	<b>10,77</b>
---	--	-----	---	-----------	--------------

## Uponor Vario Verteilerschrank Aufputz AP

 <b>1045478</b>	600x156mm	11	1	St. MZ	<b>207,27</b>
<b>1045479</b>	800x156mm	10	1	St. MZ	<b>232,47</b>
<b>1045480</b>	1000x156mm	9	1	St. MZ	<b>279,17</b>
<b>1045481</b>	1350x156mm	8	1	St. MZ	<b>336,68</b>

## Uponor Vario Schrankrückwand AP

 <b>1045482</b>	580mm	15	1	St. MZ	<b>118,27</b>
<b>1045483</b>	780mm	30	1	St. MZ	<b>141,40</b>
<b>1045484</b>	980mm	20	1	St. MZ	<b>155,78</b>
<b>1045485</b>	1330mm	-	1	St. MZ	<b>206,08</b>

## Uponor Magna Verteilerschrank Aufputz

 <b>1060553</b>	1010x835x200mm	-	1	St. MZ	<b>365,00</b>
<b>1060554</b>	1910x835x200mm	-	1	St. MZ	<b>496,40</b>
<b>1060555</b>	2310x835x200mm	-	1	St. MZ	<b>550,00</b>

# Verteilerschränke Einbaumaße

## Bestückungsoptionen und Einbaumaße für Uponor Verteiler Vario PLUS, Vario M und Vario S

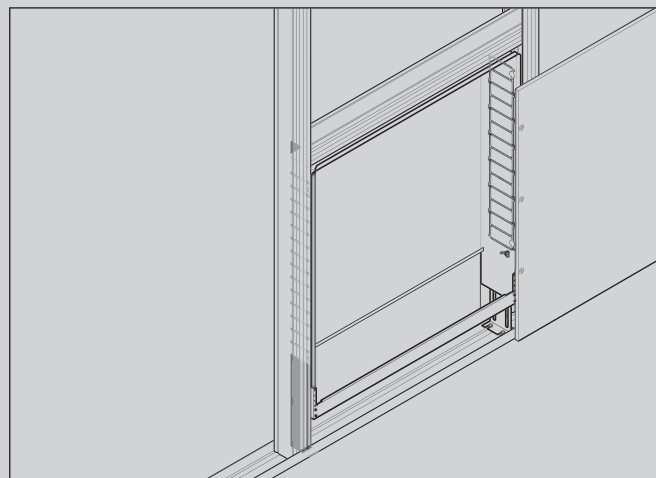
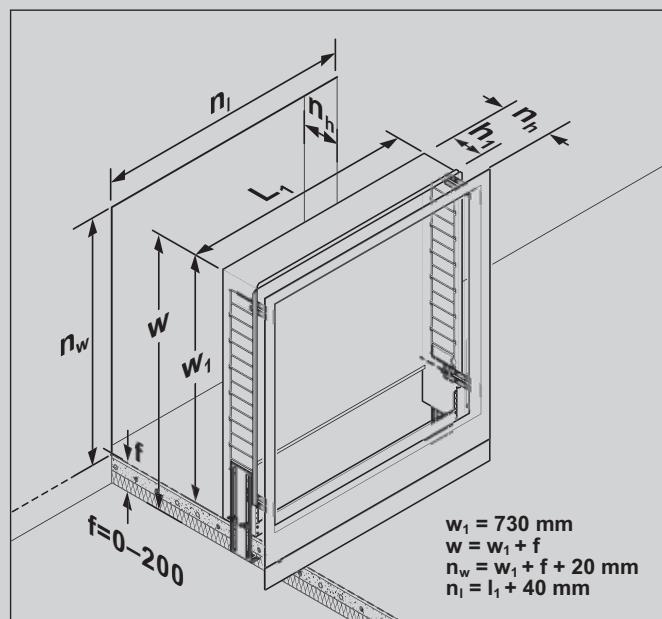

mit Uponor Vario PLUS Verteiler	Variante	Anschlusssituation	Verteilerschrank Breite $l_1$ (mm)						$h_1$ (mm)	$n_h$ min. (mm)
			550	700	850	1000	1150	1300		
geeignet für Anzahl Heizkreise										
	1	Vertikal (ohne Vario WMZ-Anschlusset)	2-4	5-7	8-10	11-13	14-15	-	80	80*
	2	Vertikal (mit Vario WMZ-Anschlusset)	2-4	5-7	8-10	11-13	14-15	-	80	95
	3	Seitlich (ohne Vario WMZ-Anschlusset)	2-5	6-8	9-11	12-14	15	-	80	80*
	4	Seitlich (mit Vario WMZ-Anschlusset)	-	2-3	4-6	7-9	10-12	13-15	80	95
	5	Mit Pumpengruppe Push 23 B	2-3	4-6	7-9	10-12	13-15	-	110	110*
	6	Mit Pumpengruppe MPG 10 / Push 23 A	-	2-4	5-7	8-10	11-13	14-15	110	110*
	7	Seitlich mit Viva Diff.-druckregler und WMZ	-	2	3-5	6-8	9-11	12-14	80	80*
	8	Vertikal mit Viva Diff.-druckregler und WMZ	-	2-3	4-6	7-9	10-12	13-15	80	95

mit Uponor Vario M Verteiler	Variante	Anschlusssituation	Verteilerschrank Breite $l_1$ (mm)						$h_1$ (mm)	$n_h$ min. (mm)
			550	700	850	1000	1150	1300		
geeignet für Anzahl Heizkreise										
	1	Vertikal (ohne Vario WMZ-Anschlusset)	2-5	6-8	9-10	11-13	14-15	-	80	80*
	2	Vertikal (mit Vario WMZ-Anschlusset)	2-5	6-8	9-10	11-13	14-15	-	80	95
	3	Seitlich (ohne Vario WMZ-Anschlusset)	2-6	7-9	10-11	12-14	15	-	80	80*
	4	Seitlich (mit Vario WMZ-Anschlusset)	-	2-4	5-7	8-10	11-12	13-15	80	95
	5	Mit Pumpengruppe Push 23 B	2-4	5-7	8-10	11-12	13-15	-	110	110*
	6	Mit Pumpengruppe MPG 10 / Push 23 A	-	2-4	5-7	8-10	11-13	14-15	110	110*
	7	Seitlich mit Viva Diff.-druckregler und WMZ	-	2-3	4-6	7-9	10-11	12-14	80	80*
	8	Vertikal mit Viva Diff.-druckregler und WMZ	-	2-4	5-7	8-10	11-12	13-15	80	95

mit Uponor Vario S Verteiler	Variante	Anschlusssituation	Verteilerschrank Breite $l_1$ (mm)						$h_1$ (mm)	$n_h$ min. (mm)
			550	700	850	1000	1150	1300		
geeignet für Anzahl Heizkreise										
	1	Vertikal (ohne Vario WMZ-Anschlusset)	2-5	6-8	9-11	12-14	15-16	-	80	80*
	2	Vertikal (mit Vario WMZ-Anschlusset)	2-5	6-8	9-11	12-14	15-16	-	80	95
	3	Seitlich (ohne Vario WMZ-Anschlusset)	2-6	7-9	10-12	13-15	16	-	80	80*
	4	Seitlich (mit Vario WMZ-Anschlusset)	-	2-4	5-7	8-10	11-13	14-16	80	95
	5	Mit Pumpengruppe Push 23 B	2-4	5-7	8-10	11-13	14-16	-	110	110*
	6	Mit Pumpengruppe MPG 10 / Push 23 A	-	2-4	5-7	8-10	11-13	14-16	110	110*
	7	Seitlich mit Viva Diff.-druckregler und WMZ	-	2-3	4-6	7-9	10-12	13-15	80	80*
	8	Vertikal mit Viva Diff.-druckregler und WMZ	-	2-4	5-7	8-10	11-13	14-16	80	95

\* plus 10 mm bei Einsatz der Kunststofftür

# Uponor Smatrix

## Systemfinder Uponor Einzelraumregelungen für Flächenheizung/-kühlung im Wohnungsbau







Heizen und Kühlen		Nur Heizen		
mit Auto-Abgleich		mit Auto-Abgleich	ohne Auto-Abgleich	
Funk	verdrahtet	Funk	verdrahtet	verdrahtet
<b>Uponor Smatrix Wave PULSE</b>	<b>Uponor Smatrix Base PULSE</b>	<b>Uponor Smatrix Wave PULSE</b>	<b>Uponor Smatrix Base PULSE</b>	<b>Uponor Base mit Flexiboard</b>

## Einzelraumregelungen Wohnungsbau

Die Uponor Regelung	... ist eine:
<b>Uponor Smatrix Wave PULSE</b>	per App gesteuerte Funk-Einzelraumregelung zum Heizen und Kühlen mit vielen Features, z.B. Anbindung an Smart Home (Alexa) und Cloud
<b>Uponor Smatrix Wave</b>	Funk-Raumtemperaturregelung für die Flächenheizung und -kühlung
<b>Uponor Smatrix Base PULSE</b>	per App gesteuerte kabelgebundene Einzelraumregelung zum Heizen und Kühlen mit vielen Features, z.B. Anbindung an Smart Home (Alexa) und Cloud
<b>Uponor Smatrix Base PRO</b>	kabelgebundene Einzelraumregelung zum Heizen und Kühlen mit bis zu 16 Regelmodulen für den Gewerbebau und für große Objekte
<b>Uponor Base</b>	konventionelle verdrahtete 230 V Einzelraumregelung zur einfachen Raumtemperaturregelung
<b>Uponor Space</b>	einfach zu bedienende Raumtemperaturregelung für Kühldecken mit Taupunktüberwachung
<b>Uponor Smatrix Style</b>	Design-Raumfühler mit Feuchteüberwachung für Smatrix Wave/Base PULSE und Smatrix Base PRO Einzelraumregelung
<b>Smatrix Move</b>	witterungsgeführter Vorlauftemperaturregler zum Heizen und Kühlen
<b>Smatrix Move PRO</b>	witterungsgeführter Mehrzonen-Vorlauftemperaturregler für den Gewerbebau zum Heizen oder Heizen/Kühlen und zusätzlich mit Schnee- und Eisfreihaltung

# Uponor Smatrix

## Funktionsumfang Smatrix Wave/Base

Uponor Smatrix Regelungstechnik	Komplettversion		ohne Cloud		nur Regelmodul	
	 Smatrix Wave PULSE	 Smatrix Base PULSE	 Smatrix Wave PULSE	 Smatrix Base PULSE	 Smatrix Wave PULSE	 Smatrix Base PULSE
Fernzugriff	■	■				
Komforteinstellung	■	■				
Absenprogramme	■	■				
Updates per App	■	■				
Einbindung Alexa	■	■				
Fernschaltung weiterer Anlagenkomponenten per Relaismodul	■					
Lokaler Zugriff über WLAN	■	■	■	■		
Max./Min.-Begrenzung der Sollwerttemperatur	■	■	■	■		
Einrichten einer Regelungsgruppe aus 4 Regelmodulen	■	■	■	■		
Erweiterte Heizen/ Kühlen-Umschalt- möglichkeiten	■	■	■	■		
Zentraler Absenkmodus	■	■	■	■		
Auto-Abgleich	■	■	■	■	■	■
Heizen und Kühlen	■	■	■	■	■	■
RF Schalterleiste		■		■		■
Regelung von Heizkörpern	■	■	■	■	■	■

# Uponor Smatrix Wave / Pulse

INHALT

Installation

Flächenheizung  
und -kühlungNahwärme-  
versorgung

Werkzeuge

Anhang

Art-Nr.	Dimension	LE	VE	ME RG	Preis/ME
---------	-----------	----	----	----------	----------

## Uponor Smatrix Wave Starter-Set Pulse S

 1093284		3	1	Set MZ	1497,66
---	--	---	---	-----------	---------

## Uponor Smatrix Wave Starter-Set Pulse L

 1093287		2	1	Set MZ	2312,23
---	--	---	---	-----------	---------

## Uponor Smatrix Schnittstelle Pulse com R-208

 1093030		16	1	St. MZ	584,76
---	--	----	---	-----------	--------

## Uponor Smatrix Wave Regelmodul Pulse X-265 6X

 1093021		4	1	St. MZ	461,29
---	--	---	---	-----------	--------

## Uponor Smatrix Wave Slave-Modul Pulse M-262 6X

 1093133		16	1	St. MZ	118,27
--	--	----	---	-----------	--------

## Uponor Smatrix Wave Antenne Pulse A-265

 1093028		16	1	St. U1	252,98
---	--	----	---	-----------	--------

## Uponor Smatrix Wave Funk Schaltmodul M-161

 1071673 2X		16	1	St. MZ	140,18
--	--	----	---	-----------	--------

## Uponor Smatrix Wave Raumtemperatur-Feuchtefühler Style T-169

 1087816		180	1	St. MZ	206,08
1087817 BLACK		180	1	St. MZ	206,08

## Uponor Smatrix Wave Raumtemperatur-Feuchtefühler Style T-161

 1087815		180	1	St. MZ	191,72
---	--	-----	---	-----------	--------

Art-Nr.	Dimension	LE	VE	ME RG	Preis/ME
---------	-----------	----	----	----------	----------

## Uponor Smatrix Wave Raumfühler prog.+RH T-168

 1086984 RAL9016		75	1	St. MZ	184,50
---	--	----	---	-----------	--------

## Uponor Smatrix Wave Raumfühler digit. T-166

 1086982 RAL9016		75	1	St. MZ	162,94
---	--	----	---	-----------	--------

## Uponor Smatrix Wave Raumfühler T-165 POD

 1086981 RAL9016		75	1	St. MZ	134,20
---	--	----	---	-----------	--------

## Uponor Smatrix Wave Raumfühler BM T-163

 1086979 RAL9016		75	1	St. MZ	177,31
---	--	----	---	-----------	--------

## Uponor Smatrix Wave Thermostatkopf T-162

 1071660		16	1	St. MZ	128,40
---	--	----	---	-----------	--------

## Uponor Smatrix Wandrahmen T-X A-1XX

 1086986 RAL9016		250	1	St. MZ	7,79
---	--	-----	---	-----------	------

## Uponor Smatrix Boden- oder Fernfühler S-1XX

 1071684		63	1	St. MZ	40,98
---	--	----	---	-----------	-------

## Uponor Smatrix Schaltmodul H/K M-1XX

 1083576 24V		84	1	St. MZ	155,76
---	--	----	---	-----------	--------

## Uponor Smatrix Schaltmodul H/K M-1XX

 1083577 230V		16	1	St. MZ	168,93
--	--	----	---	-----------	--------

## Uponor Smatrix Thermoantrieb Retrofit A-XXX

 1083575 24V, NC, 1W		100	1	Set MZ	59,32
---	--	-----	---	-----------	-------

# Uponor Smatrix Base / Pulse

Art-Nr.	Dimension	LE	VE	ME RG	Preis/ME
---------	-----------	----	----	----------	----------

## Uponor Smatrix Base Starter-Set Pulse S

 <b>1093280</b>		3	1	Set MZ	<b>1306,15</b>
--	--	---	---	-----------	----------------

## Uponor Smatrix Base Starter-Set Pulse L

 <b>1093282</b>		2	1	Set MZ	<b>1929,20</b>
--	--	---	---	-----------	----------------

## Uponor Smatrix Schnittstelle Pulse com R-208

 <b>1093030</b>		16	1	St. MZ	<b>584,76</b>
--	--	----	---	-----------	---------------

## Uponor Smatrix Base Regelmodul Pulse X-245 BUS 6X

 <b>1093017</b>		4	1	St. MZ	<b>311,53</b>
--	--	---	---	-----------	---------------

## Uponor Smatrix Base Slave-Modul Pulse M-242 BUS 6X

 <b>1093134</b>		16	1	St. MZ	<b>105,80</b>
--	--	----	---	-----------	---------------

## Uponor Smatrix Base Stern-Modul Pulse M-243 BUS 6X

 <b>1093135</b>		16	1	St. MZ	<b>80,88</b>
--	--	----	---	-----------	--------------

## Uponor Smatrix Base Raumtemperatur-Feuchtefühler Style T-149 Bus

 <b>1087813</b>		180	1	St. MZ	<b>191,72</b>
 <b>1087814</b> BLACK		180	1	St. MZ	<b>191,72</b>

## Uponor Smatrix Base PRO Raumtemperatur-Feuchtefühler Style T-141 Bus

 <b>1087812</b> FLUSH		180	1	St. MZ	<b>108,92</b>
--	--	-----	---	-----------	---------------

## Uponor Smatrix Base Raumfühler prog.+RH T-148 Bus

 <b>1086977</b> RAL9016		75	1	St. MZ	<b>120,99</b>
--	--	----	---	-----------	---------------

## Uponor Smatrix Base Raumfühler digit. T-146 Bus

 <b>1086976</b> RAL9016		75	1	St. MZ	<b>111,56</b>
--	--	----	---	-----------	---------------

Art-Nr.	Dimension	LE	VE	ME RG	Preis/ME
---------	-----------	----	----	----------	----------

## Uponor Smatrix Base Raumthermostat T-145 Bus POD

 <b>1086975</b> RAL9016		75	1	St. MZ	<b>55,11</b>
--	--	----	---	-----------	--------------

## Uponor Smatrix Base Raumfühler UP T-144 Bus

 <b>1086973</b> RAL9016		60	1	St. MZ	<b>87,59</b>
--	--	----	---	-----------	--------------

## Uponor Smatrix Base Raumfühler BM T-143 Bus

 <b>1086972</b> RAL9016		75	1	St. MZ	<b>76,21</b>
--	--	----	---	-----------	--------------

## Uponor Smatrix Boden- oder Fernfühler S-1XX

 <b>1071684</b>		63	1	St. MZ	<b>40,98</b>
--	--	----	---	-----------	--------------

## Uponor Smatrix Base Aufputz-Wandrahmen Style T-149 A-14X

 <b>1087821</b>		90	1	St. MZ	<b>8,20</b>
 <b>1087822</b> BLACK		90	1	St. MZ	<b>9,30</b>

## Uponor Smatrix Wandrahmen T-X A-1XX

 <b>1086986</b> RAL9016		250	1	St. MZ	<b>7,79</b>
--	--	-----	---	-----------	-------------

## Uponor Smatrix Base Bus-Kabel A-145

 <b>1071670</b> 50m		2	1	St. MZ	<b>159,20</b>
--	--	---	---	-----------	---------------

## Uponor Smatrix Schaltmodul H/K M-1XX

 <b>1083576</b> 24V		84	1	St. MZ	<b>155,76</b>
--	--	----	---	-----------	---------------

## Uponor Smatrix Schaltmodul H/K M-1XX

 <b>1083577</b> 230V		16	1	St. MZ	<b>168,93</b>
---	--	----	---	-----------	---------------

## Uponor Smatrix Thermoantrieb Retrofit A-XXX

 <b>1083575</b> 24V, NC, 1W		100	1	Set MZ	<b>59,32</b>
--	--	-----	---	-----------	--------------



# Uponor Smatrix Base PRO

Art-Nr.	Dimension	LE	VE	ME	Preis/ME
---------	-----------	----	----	----	----------

## Uponor Smatrix Base PRO Regler X-147 Bus

 <b>1087162</b>	6X		4	1	St. MZ	<b>688,90</b>
--	----	--	---	---	-----------	---------------

## Uponor Smatrix Base PRO Bedienmodul I-147 Bus

 <b>1087161</b>			7	1	St. MZ	<b>664,99</b>
--	--	--	---	---	-----------	---------------

Art-Nr.	Dimension	LE	VE	ME	Preis/ME
---------	-----------	----	----	----	----------

## Uponor Smatrix Base PRO Raumtemperatur-Feuchtefühler Style T-141 Bus

 <b>1087812</b>	FLUSH		180	1	St. MZ	<b>108,92</b>
--	-------	--	-----	---	-----------	---------------

## Uponor Smatrix Base PRO KNX Schnittstelle R-147 KNX

 <b>1087164</b>			-	1	St. MZ	<b>886,53</b>
--	--	--	---	---	-----------	---------------

# Uponor Space

Art-Nr.	Dimension	LE	VE	ME	Preis/ME
---------	-----------	----	----	----	----------

## Uponor Space Schnittstellenkonverter TK 1PF

 <b>1000314</b>	24V		-	1	St. B6	<b>234,02</b>
--	-----	--	---	---	-----------	---------------

## Uponor Space Taupunktfühler TF 3 PR

 <b>1000312</b>	24V		10	1	St. B6	<b>186,95</b>
--	-----	--	----	---	-----------	---------------

## Uponor Space Taupunktfühler TF 3 GM

 <b>1000313</b>	24V		25	1	St. B6	<b>186,95</b>
--	-----	--	----	---	-----------	---------------

Art-Nr.	Dimension	LE	VE	ME	Preis/ME
---------	-----------	----	----	----	----------

## Uponor Vario VL-Feinregulierventil

 <b>1005107</b>	1/2" - G3/4		50	1	St. MZ	<b>29,84</b>
--	-------------	--	----	---	-----------	--------------

## Uponor Vario RL-Ventil

 <b>1005108</b>	1/2" - G3/4		50	1	St. MZ	<b>29,05</b>
--	-------------	--	----	---	-----------	--------------

## Uponor Vario Regulierventil

 <b>1005100</b>	G1 - Rp1		10	1	Set MZ	<b>105,00</b>
--	----------	--	----	---	-----------	---------------

# Uponor Base

Art-Nr.	Dimension	LE	VE	ME RG	Preis/ME
---------	-----------	----	----	----------	----------

## Uponor Base 6 Kanal Regelmodul X-23

 <b>1058426</b>	6X 230V	200	1	St. MZ	<b>155,76</b>
--	---------	-----	---	-----------	---------------

## Uponor Base flexiboard X-24

 <b>1088331</b>	6X 230V	-	1	St. MZ	<b>184,52</b>
--	---------	---	---	-----------	---------------

## Uponor Base flexiboard mit Pumpenlogik X-25

 <b>1089086</b>	6X 230V	-	1	St. MZ	<b>194,08</b>
--	---------	---	---	-----------	---------------

## Uponor Base flexiboard X-26

 <b>1089087</b>	8X 230V	-	1	St. MZ	<b>204,90</b>
--	---------	---	---	-----------	---------------

## Uponor Base flexiboard mit Pumpenlogik X-27

 <b>1089088</b>	8X 230V	-	1	St. MZ	<b>225,27</b>
--	---------	---	---	-----------	---------------

## Uponor Vario S Thermoantrieb Edelstahlv. NC

 <b>1013006</b>	230V FT30x1,5	10	1	St. MZ	<b>37,34</b>
--	---------------	----	---	-----------	--------------

## Uponor Vario PLUS Thermoantrieb NC

 <b>1005605</b>	230V MT30x1,5	10	1	St. MZ	<b>70,09</b>
--	---------------	----	---	-----------	--------------

## Uponor Vario B Stellantrieb NC

 <b>1022244</b>	230V FT28x1,5	10	1	St. MZ	<b>70,09</b>
--	---------------	----	---	-----------	--------------

Art-Nr.	Dimension	LE	VE	ME RG	Preis/ME
---------	-----------	----	----	----------	----------

## Uponor Base Raumfühler T-23

 <b>1058422</b>	230V RAL9010	160	1	St. MZ	<b>48,77</b>
--	--------------	-----	---	-----------	--------------

## Uponor Base Raumfühler UP T-24

 <b>1058423</b>	230V	-	1	St. MZ	<b>91,43</b>
--	------	---	---	-----------	--------------

## Uponor Base Raumfühler H/K T-25

 <b>1058424</b>	230V	-	1	St. MZ	<b>68,17</b>
--	------	---	---	-----------	--------------

## Uponor Base Prog. Raumfühler T-26

 <b>1058425</b>	230V RAL9010	-	1	St. MZ	<b>131,77</b>
--	--------------	---	---	-----------	---------------

## Uponor Base Fernfühler

 <b>1047459</b>	230V	-	1	St. MZ	<b>23,24</b>
---	------	---	---	-----------	--------------

# Uponor Smatrix Move PRO

Art-Nr.	Dimension	LE	VE	ME RG	Preis/ME
---------	-----------	----	----	----------	----------

## Uponor Smatrix Move PRO Regler X-159

 1087155		10	1	St. MZ	2528,40
---	--	----	---	-----------	---------

## Uponor Smatrix Move PRO Regelung Schnee-Eisfreihaltung Set S-152 + S-158

 1087158		-	1	Set MZ	2695,77
1087156		5	1	St. MZ	1317,95

Art-Nr.	Dimension	LE	VE	ME RG	Preis/ME
---------	-----------	----	----	----------	----------

## Uponor Smatrix Move PRO Raumfühler S-155

 1087159		10	1	St. MZ	154,57
---	--	----	---	-----------	--------

## Uponor Smatrix Move PRO Feuchtfühler S-157

 1087160		75	1	St. MZ	629,01
---	--	----	---	-----------	--------

## Uponor Smatrix Move PRO Kondensationsschutz Set S-159

 1087165		10	1	Set MZ	610,93
---	--	----	---	-----------	--------

# Uponor Smatrix Move

## Uponor Smatrix Move Regler X-157 Wired

 1071693		4	1	Set MZ	1018,38
---	--	---	---	-----------	---------

## Uponor Smatrix Move PLUS Antenne A-155 Radio

 1071676		21	1	St. U1	193,39
---	--	----	---	-----------	--------

## Uponor Smatrix Move Vorl./Rücklauffühler S-152

 1071661	3m	63	1	St. MZ	97,42
---	----	----	---	-----------	-------

## Uponor Smatrix Außenfühler S-1XX

 1071671		45	1	St. MZ	125,81
---	--	----	---	-----------	--------

## Uponor Smatrix Schaltmodul H/K M-1XX

 1083577	230V	16	1	St. MZ	168,93
---	------	----	---	-----------	--------

## Uponor Fluvia Move PLUS Mischermotor 230V

 1119812		10	1	St. U1	320,70
---	--	----	---	-----------	--------

## Uponor Smatrix Move Mischermotor 230V

 1002357		-	1	St. MZ	234,70
---	--	---	---	-----------	--------

# Uponor Fluvia

Art-Nr.	Dimension	LE	VE	ME RG	Preis/ME
---------	-----------	----	----	----------	----------

## Uponor Fluvia T Pumpengruppe Push-12 TH-G

 1095127		60	1	St. MZ	676,94
---	--	----	---	-----------	--------

## Uponor Fluvia T Pumpengruppe Push-12 CH-G

 1095131		30	1	St. MZ	1593,64
---	--	----	---	-----------	---------

## Uponor Fluvia T Regeleinheit Push-12-CH-X

 1085982		50	1	St. MZ	898,52
---	--	----	---	-----------	--------

## Uponor Fluvia T Pumpengruppe Push-12 AC-G

 1095128		60	1	St. MZ	802,79
---	--	----	---	-----------	--------

## Uponor Fluvia T Pumpengruppe Push-12 WL-G

 1095130		60	1	St. MZ	1072,29
---	--	----	---	-----------	---------

## Uponor Fluvia Hosenstück

 1005675	2xG $\frac{3}{4}$ - $\frac{3}{4}$ "Euro	50	1	Set MZ	41,50
---	---	----	---	-----------	-------

## Uponor Vario Füll / Entleerungshahn

 1061802	$\frac{3}{4}$ " - $\frac{3}{4}$ "	10	1	Set MZ	64,58
---	-----------------------------------	----	---	-----------	-------

## Uponor Aqua PLUS Verteilerkappe m. Dichtung

 1001337	$\frac{3}{4}$ "FT	250	10	St. F1	5,88
---	-------------------	-----	----	-----------	------

## Uponor Fluvia T Grundfos Pumpenkopf Push-12

 1095132		20	1	St. U1	300,40
---	--	----	---	-----------	--------

## Uponor Fluvia Ventil für Push 12

 1059851		-	1	St. U1	136,21
---	--	---	---	-----------	--------

## Uponor Fluvia Thermostat für 1059834 PUSH 12 TH

 1059852		-	1	St. U1	121,14
---	--	---	---	-----------	--------

Art-Nr.	Dimension	LE	VE	ME RG	Preis/ME
---------	-----------	----	----	----------	----------

## Uponor Fluvia Move Pumpengruppe Push-23-A-AC

 1085008		30	1	St. MZ	1641,58
---	--	----	---	-----------	---------

## Uponor Fluvia T Pumpengruppe Push-23-B-W

 1078304		55	1	St. MZ	1060,27
---	--	----	---	-----------	---------

## Uponor Fluvia T Thermostat mit Fernfühler Push-23, KRS-6

 1063461		-	1	St. U1	117,13
---	--	---	---	-----------	--------

## Uponor Fluvia Rücklauf-Regulierventil Push-23, MPG, KRS-6

 1059282		10	1	St. U1	45,22
---	--	----	---	-----------	-------

## Uponor Fluvia Vorlauf-Thermostatventil Push-23, KRS-6

 1059283		10	1	St. U1	45,22
---	--	----	---	-----------	-------

## Uponor Fluvia Mischventil für PUSH-23 Push-23, KRS-6

 1061525	$\frac{3}{4}$ x G1 x G1	-	1	St. U1	115,54
---	-------------------------	---	---	-----------	--------

## Uponor Fluvia Move Pumpengruppe MPG-10-A-W

 1078306		30	1	St. MZ	3259,34
---	--	----	---	-----------	---------

## Uponor Fluvia Pumpengruppe MPG-10-B-W

 1078307		30	1	St. MZ	1366,00
---	--	----	---	-----------	---------

## Uponor Fluvia Pumpe Wilo Para SC

 1095309	6m, 180mm	-	1	St. U1	641,40
---	-----------	---	---	-----------	--------

# Uponor Fluvia

Art-Nr.	Dimension	LE	VE	ME RG	Preis/ME
 <b>1058573</b>	G1-G1A	30	1	St. MZ	<b>23,37</b>

## Uponor Fluvia Mischventil für 1048780 MPG

 <b>1071964</b>		-	1	St. U1	<b>232,28</b>
--	--	---	---	-----------	---------------

## Uponor Fluvia Move Pumpengruppe CPG-15-C-W

 <b>NEU 1119445</b>		18	1	St. MZ	<b>2240,35</b>
--	--	----	---	-----------	----------------

## Uponor Fluvia Pumpengruppe CPG-15-D-W

 <b>1119448</b>		18	1	St. MZ	<b>1137,41</b>
--	--	----	---	-----------	----------------

## Uponor Fluvia Dreiwegemischer CPG, EPG

 <b>1119813</b>		10	1	St. U1	<b>192,42</b>
---	--	----	---	-----------	---------------

## Uponor Fluvia Move PLUS Mischermotor 230V

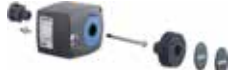
 <b>1119812</b>		10	1	St. U1	<b>320,70</b>
--	--	----	---	-----------	---------------

## Uponor Fluvia Max.-Begrenzungstherm.

 <b>1005504</b>	5-60	10	1	St. MZ	<b>69,74</b>
--	------	----	---	-----------	--------------

Art-Nr.	Dimension	LE	VE	ME RG	Preis/ME
 <b>1084143</b>		22	1	St. MZ	<b>3726,61</b>

## Uponor Fluvia Move Pumpengruppe PPG-30-A-W

## Uponor Fluvia Move PLUS Pumpengruppe EPG-6-A-W

 <b>1078310</b>		8	1	St. MZ	<b>4421,49</b>
--	--	---	---	-----------	----------------

## Uponor Smatrix Move Mischermotor pro

 <b>1002356</b>	A-15X 24V 0-10 V	-	1	St. MZ	<b>325,45</b>
--	------------------	---	---	-----------	---------------

## Uponor Smatrix Move Mischermotor 230V

 <b>1002357</b>		-	1	St. MZ	<b>234,70</b>
--	--	---	---	-----------	---------------

## Uponor Fluvia Pumpe Wilo Yonos Para

 <b>1059854</b>	RS15/6 G1 130mm	-	1	St. U1	<b>790,58</b>
---	-----------------	---	---	-----------	---------------

# Verbindungstechnik, Fittings und Werkzeuge für Uponor Ecoflex Rohre

Systemrohr	Abmessung [mm]	Medium- rohr	Dämmung	Mantel- rohr	Temperatur- und Druckbelastung	Länge [m]	Artikel-Nr.	Zertifizierung
<b>VIP Thermo Single</b> 	40 x 3,7/140	PE-Xa + EVOH	VIP + PEX-Schaum	PE-HD	max. 95 °C / 6 bar	200	1095714	CSTB System-zertifizierung
	50 x 4,6/140					200	1095715	
	63 x 5,8/140					200	1095716	
	75 x 6,8/140					200	1095717	
	90 x 8,2/175					150	1095718	
	110 x 10,0/175					150	1095719	
	125 x 11,4/200					120	1095720	
<b>VIP Thermo Twin</b> 	2x25 x 2,3/140	PE-Xa + EVOH	VIP + PEX-Schaum	PE-HD	max. 95 °C / 6 bar	200	1118580	CSTB System-zertifizierung
	2x32 x 2,9/140					200	1118581	
	2x40 x 3,7/175					200	1118582	
	2x50 x 4,6/175					200	1118583	
	2x63 x 5,8/200					100	1118584	
	2x75 x 6,8/250					100	1118585	
	<b>Thermo Single</b> <small>optional mit Heizkabel</small> 					25 x 2,3/140	PE-Xa + EVOH	
32 x 2,9/140		200	1018110					
40 x 3,7/175		200	1018111					
50 x 4,6/175		200	1018112					
63 x 5,8/175		200	1018113					
75 x 6,8/200		100	1018114					
90 x 8,2/200		100	1018115					
110 x 10,0/200		100	1018116					
<b>Thermo Twin</b> 	2x25 x 2,3/175	PE-Xa + EVOH	PEX-Schaum	PE-HD	max. 95 °C / 6 bar	200	1018134	KOMO Systemzertifizierung, Deklaration nach DIN EN 15632, DIN CERTCO Wärmeverlustzertifizierung - Überwacht nach VDI 2055, CSTB Systemzertifizierung
	2x32 x 2,9/175					200	1018135	
	2x40 x 3,7/175					200	1018136	
	2x50 x 4,6/200					100	1018137	
	2x63 x 5,8/200					100	1018138	
<b>Thermo Mini</b> 	25 x 2,3/68	PE-Xa + EVOH	PEX-Schaum	PE-HD	max. 95 °C / 6 bar	200	1018132	CSTB System-zertifizierung
	32 x 2,9/68					200	1018133	
<b>Thermo Twin HP*</b> <small>* Integrierte Leerrohre für Kabel</small> 	2x32 x 2,9-2x32 x 3,5/140	PE-Xa + EVOH	PEX-Schaum	PE-HD	max. 95 °C / 6 bar	200	1093894	
	2x40 x 3,7-2x32 x 3,5/175					200	1093895	





# Verbindungstechnik, Fittings und Werkzeuge für Uponor Ecoflex Rohre

	Systemrohr	Abmessung [mm]	Mediumrohr	Dämmung	Mantelrohr	Temperatur- und Druckbelastung	Länge [m]	Artikel-Nr.	Zertifizierung	Zubehör  Gummi-Endkappe
HEIZEN UND KÜHLEN	Varia Single 	25 x 2,3/90	PE-Xa + EVOH	PEX-Schaum	PE-HD	max. 95 °C / 6 bar	200	1018230	CSTB System-zertifizierung	
		32 x 2,9/90					200	1018231		
		40 x 3,7/140					200	1018232		
		50 x 4,6/140					200	1018233		
		63 x 5,8/140					200	1018234		
		75 x 6,8/175					200	1018235		
		90 x 8,2/175					100	1018236		
		110 x 10,0/175					100	1018237		
		125 x 11,4/200					120	1062886		
	Varia Twin 	2x25 x 2,3/140	PE-Xa + EVOH	PEX-Schaum	PE-HD	max. 95 °C / 6 bar	200	1018238	CSTB System-zertifizierung	
		2x32 x 2,9/140					200	1018239		
		2x40 x 3,7/140					200	1018240		
		2x50 x 4,6/175					200	1018241		
VIP Aqua Single 	40 x 5,5/140	PE-Xa	VIP + PEX-Schaum	PE-HD	max. 95 °C / 10 bar	200	1119047	DVGW, ÖVGW		
	50 x 6,9/140					200	1119048			
	63 x 8,6/140					200	1119049			
VIP Aqua Twin 	25 x 3,5-20 x 2,8/140	PE-Xa	VIP + PEX-Schaum	PE-HD	max. 95 °C / 10 bar	200	1119053	DVGW, ÖVGW		
	32 x 4,4-20 x 2,8/140					200	1119054			
	40 x 5,5-25 x 3,5/140					200	1119055			
	50 x 6,9-32 x 4,4/175					200	1119056			
Aqua Single optional mit Heizkabel 	25 x 3,5/140	PE-Xa	PEX-Schaum	PE-HD	max. 95 °C / 10 bar	200	1018117	DVGW, ÖVGW		
	32 x 4,4/140					200	1018118			
	40 x 5,5/175					200	1018119			
	50 x 6,9/175					200	1018120			
	63 x 8,6/175					200	1018121			
Aqua Twin 	25 x 3,5-25 x 3,5/175	PE-Xa	PEX-Schaum	PE-HD	max. 95 °C / 10 bar	200	1018139	DVGW, ÖVGW		
	32 x 4,4-25 x 3,5/175					200	1018140			
	40 x 5,5-25 x 3,5/175					200	1018141			
	50 x 6,9-25 x 3,5/175					200	1018142			
Quattro 	2x25 x 2,3-2x25 x 3,5/175	PE-Xa + EVOH + PE-Xa	PEX-Schaum	PE-HD	max. 95 °C / 6 / 10 bar	200	1018147	DVGW, ÖVGW		
	2x32 x 2,9-2x25 x 3,5/175					200	1018148			
	2x32 x 2,9-32 x 4,4-25 x 3,5/175					200	1018149			
	2x40 x 3,7-32 x 4,4-20 x 2,8/200					100	1084891			
	2x40 x 3,7-40 x 5,5-25 x 3,5/200					100	1084890			
Supra 	25 x 2,3/68	PE 100-RC schwarz mit blauen Streifen	PEX-Schaum	PE-HD	20 °C / 16 bar	200	1095722	DVGW		
	32 x 2,9/68					200	1095723			
	40 x 3,7/140					200	1095724			
	50 x 4,6/140					200	1095725			
	63 x 5,8/140					200	1095726			
	75 x 6,8/175					100	1095727			
	90 x 8,2/175					100	1095728			
	110 x 10,0/200					100	1095729			
Supra PLUS Cable Mit Frostschutzkabel 	25 x 2,3/68	PE 100-RC schwarz mit blauen Streifen	PEX-Schaum	PE-HD	20 °C / 16 bar	150	1095730	DVGW		
	32 x 2,9/68					150	1095731			
	40 x 3,7/140					150	1095734			
	50 x 4,6/140					150	1095736			
	63 x 5,8/140					150	1095737			
	75 x 6,8/175					150	1095738			
	90 x 8,2/200					100	1095739			
	110 x 10,0/200					100	1095740			



# Uponor Ecoflex Nahwärmeversorgung

Art-Nr.	Dimension	LE	VE	ME RG	Preis/ME
---------	-----------	----	----	----------	----------

## Uponor Ecoflex VIP Thermo

### Uponor Ecoflex VIP Thermo Single

 <b>1095714</b>	40X3,7/140	-	200	<sup>m</sup> <sub>H7</sub>	<b>63,06</b>
<b>1095715</b>	50X4,6/140	-	200	<sup>m</sup> <sub>H7</sub>	<b>78,28</b>
<b>1095716</b>	63X5,8/140	-	200	<sup>m</sup> <sub>H7</sub>	<b>99,69</b>
<b>1095717</b>	75X6,8/140	-	200	<sup>m</sup> <sub>H7</sub>	<b>125,75</b>
<b>1095718</b>	90X8,2/175	-	150	<sup>m</sup> <sub>H7</sub>	<b>131,34</b>
<b>1095719</b>	110X10,0/175	-	150	<sup>m</sup> <sub>H7</sub>	<b>146,21</b>
<b>1095720</b>	125X11,4/200	-	120	<sup>m</sup> <sub>H7</sub>	<b>201,65</b>

### Uponor Ecoflex VIP Thermo Twin

 <b>1118580</b>	2x25x2,3/140	-	200	<sup>m</sup> <sub>H7</sub>	<b>66,62</b>
<b>1118581</b>	2x32x2,9/140	-	200	<sup>m</sup> <sub>H7</sub>	<b>77,80</b>
<b>1118582</b>	2x40x3,7 /175	-	200	<sup>m</sup> <sub>H7</sub>	<b>95,41</b>
<b>1118583</b>	2x50x4,6/175	-	200	<sup>m</sup> <sub>H7</sub>	<b>122,41</b>
<b>1118584</b>	2x63x5,8/200	-	100	<sup>m</sup> <sub>H7</sub>	<b>143,71</b>
<b>1118585</b>	2x75x6,8/250	-	100	<sup>m</sup> <sub>H7</sub>	<b>197,72</b>

Art-Nr.	Dimension	LE	VE	ME RG	Preis/ME
---------	-----------	----	----	----------	----------

## Uponor Ecoflex Varia

### Uponor Ecoflex Varia Single

 <b>1018230</b>	25x2,3 /90	-	200	<sup>m</sup> <sub>H6</sub>	<b>34,11</b>
<b>1018231</b>	32x2,9 /90	-	200	<sup>m</sup> <sub>H6</sub>	<b>41,76</b>
<b>1018232</b>	40x3,7 /140	-	200	<sup>m</sup> <sub>H6</sub>	<b>51,61</b>
<b>1018233</b>	50x4,6 /140	-	200	<sup>m</sup> <sub>H6</sub>	<b>64,04</b>
<b>1018234</b>	63x5,8 /140	-	200	<sup>m</sup> <sub>H6</sub>	<b>81,53</b>
<b>1018235</b>	75x6,8 /175	-	200	<sup>m</sup> <sub>H6</sub>	<b>100,17</b>
<b>1018236</b>	90x8,2 /175	-	100	<sup>m</sup> <sub>H6</sub>	<b>104,60</b>
<b>1018237</b>	110x10,0 /175	-	100	<sup>m</sup> <sub>H6</sub>	<b>116,44</b>
<b>1062886</b>	125x11,4/200	-	120	<sup>m</sup> <sub>H6</sub>	<b>176,09</b>

### Uponor Ecoflex Varia Twin

 <b>1018238</b>	2x25x2,3/140	-	200	<sup>m</sup> <sub>H6</sub>	<b>54,46</b>
<b>1018239</b>	2x32x2,9/140	-	200	<sup>m</sup> <sub>H6</sub>	<b>62,25</b>
<b>1018240</b>	2x40x3,7/140	-	200	<sup>m</sup> <sub>H6</sub>	<b>78,09</b>
<b>1018241</b>	2x50x4,6/175	-	200	<sup>m</sup> <sub>H6</sub>	<b>100,17</b>

## Uponor Ecoflex Thermo

### Uponor Ecoflex Thermo Single

 <b>1018109</b>	25x2,3/140	-	200	<sup>m</sup> <sub>H1</sub>	<b>37,81</b>
<b>1018110</b>	32x2,9/140	-	200	<sup>m</sup> <sub>H1</sub>	<b>46,43</b>
<b>1018111</b>	40x3,7/175	-	200	<sup>m</sup> <sub>H1</sub>	<b>57,27</b>
<b>1018112</b>	50x4,6/175	-	200	<sup>m</sup> <sub>H1</sub>	<b>71,19</b>
<b>1018113</b>	63x5,8/175	-	200	<sup>m</sup> <sub>H1</sub>	<b>90,58</b>
<b>1018114</b>	75x6,8/200	-	100	<sup>m</sup> <sub>H1</sub>	<b>111,29</b>
<b>1018115</b>	90x8,2/200	-	100	<sup>m</sup> <sub>H1</sub>	<b>116,22</b>
<b>1018116</b>	110x10,0/200	-	100	<sup>m</sup> <sub>H1</sub>	<b>129,39</b>

### Uponor Ecoflex Thermo Twin

 <b>1018134</b>	2x25x2,3/175	-	200	<sup>m</sup> <sub>H1</sub>	<b>60,52</b>
<b>1018135</b>	2x32x2,9/175	-	200	<sup>m</sup> <sub>H1</sub>	<b>70,74</b>
<b>1018136</b>	2x40x3,7 /175	-	200	<sup>m</sup> <sub>H1</sub>	<b>86,76</b>
<b>1018137</b>	2x50x4,6/200	-	100	<sup>m</sup> <sub>H1</sub>	<b>111,29</b>
<b>1018138</b>	2x63x5,8/200	-	100	<sup>m</sup> <sub>H1</sub>	<b>130,61</b>

### Uponor Ecoflex Thermo Mini

 <b>1018132</b>	25x2,3/68	-	200	<sup>m</sup> <sub>H1</sub>	<b>27,71</b>
<b>1018133</b>	32x2,9/68	-	200	<sup>m</sup> <sub>H1</sub>	<b>34,36</b>

### Uponor Ecoflex Thermo Twin HP

 <b>1093894</b>	2x32x2,9-2x32x3,5/140	-	200	<sup>m</sup> <sub>H1</sub>	<b>63,66</b>
<b>1093895</b>	2x40x3,7-2x32x3,5/175	-	200	<sup>m</sup> <sub>H1</sub>	<b>82,42</b>

# Uponor Ecoflex Nahwärmerversorgung

Art-Nr.	Dimension	LE	VE	ME RG	Preis/ME
---------	-----------	----	----	----------	----------

## Uponor Ecoflex VIP Aqua

### Uponor Ecoflex VIP Aqua Single

 <b>1119047</b>	40x5,5/140	-	200	$\frac{m}{H7}$	<b>91,84</b>
<b>1119048</b>	50x6,9/140	-	200	$\frac{m}{H7}$	<b>108,14</b>
<b>1119049</b>	63x8,6/140	-	200	$\frac{m}{H7}$	<b>136,82</b>

### Uponor Ecoflex VIP Aqua Twin

 <b>1119053</b>	25x3,5-20x2,8/140	-	200	$\frac{m}{H7}$	<b>69,96</b>
<b>1119054</b>	32x4,4-20x2,8/140	-	200	$\frac{m}{H7}$	<b>85,77</b>
<b>1119055</b>	40x5,5-25x3,5/140	-	200	$\frac{m}{H7}$	<b>102,07</b>
<b>1119056</b>	50x6,9-32x4,4/175	-	200	$\frac{m}{H7}$	<b>139,90</b>

## Uponor Ecoflex Aqua

### Uponor Ecoflex Aqua Single

 <b>1018117</b>	25x3,5/140	-	200	$\frac{m}{H1}$	<b>48,54</b>
<b>1018118</b>	32x4,4/140	-	200	$\frac{m}{H1}$	<b>53,03</b>
<b>1018119</b>	40x5,5/175	-	200	$\frac{m}{H1}$	<b>83,50</b>
<b>1018120</b>	50x6,9/175	-	200	$\frac{m}{H1}$	<b>98,28</b>
<b>1018121</b>	63x8,6/175	-	200	$\frac{m}{H1}$	<b>124,37</b>

### Uponor Ecoflex Aqua Twin

 <b>1018139</b>	25x3,5-25x3,5/175	-	200	$\frac{m}{H1}$	<b>63,60</b>
<b>1018140</b>	32x4,4-25x3,5/175	-	200	$\frac{m}{H1}$	<b>78,00</b>
<b>1018141</b>	40x5,5-25x3,5/175	-	200	$\frac{m}{H1}$	<b>92,79</b>
<b>1018142</b>	50x6,9-25x3,5/175	-	200	$\frac{m}{H1}$	<b>127,18</b>

Art-Nr.	Dimension	LE	VE	ME RG	Preis/ME
---------	-----------	----	----	----------	----------

## Uponor Ecoflex Quattro

### Uponor Ecoflex Quattro

 <b>1018147</b>	2x25x2,3-2x25x3,5/175	-	200	$\frac{m}{H1}$	<b>116,72</b>
<b>1018148</b>	2x32x2,9-2x25x3,5/175	-	200	$\frac{m}{H1}$	<b>130,40</b>
<b>1018149</b>	2x32x2,9-32x4,4-25x3,5/175	-	200	$\frac{m}{H1}$	<b>139,46</b>
<b>1084891</b>	2x40x3,7-32x4,4-20x2,8/200	-	100	$\frac{m}{H1}$	<b>146,42</b>
<b>1084890</b>	2x40x3,7-40x5,5-25x3,5/200	-	100	$\frac{m}{H1}$	<b>150,86</b>

# Uponor Ecoflex Nahwärmeversorgung

Art-Nr.	Dimension	LE	VE	ME RG	Preis/ME
---------	-----------	----	----	----------	----------

## Uponor Ecoflex Supra

### Uponor Ecoflex Supra

 <b>1095722</b>	25x2,3/68	-	200	<sup>m</sup> <sub>H1</sub>	<b>24,56</b>
<b>1095723</b>	32x2,9/68	-	200	<sup>m</sup> <sub>H1</sub>	<b>28,66</b>
<b>1095724</b>	40x3,7/140	-	200	<sup>m</sup> <sub>H1</sub>	<b>37,81</b>
<b>1095725</b>	50x4,6/140	-	200	<sup>m</sup> <sub>H1</sub>	<b>41,92</b>
<b>1095726</b>	63x5,8/140	-	200	<sup>m</sup> <sub>H1</sub>	<b>43,42</b>
<b>1095727</b>	75x6,8/175	-	150	<sup>m</sup> <sub>H1</sub>	<b>52,29</b>
<b>1095728</b>	90x8,2/175	-	100	<sup>m</sup> <sub>H1</sub>	<b>55,11</b>
<b>1095729</b>	110x10,0/200	-	100	<sup>m</sup> <sub>H1</sub>	<b>74,00</b>

Art-Nr.	Dimension	LE	VE	ME RG	Preis/ME
---------	-----------	----	----	----------	----------

### Uponor Ecoflex Supra PLUS cable

 <b>1095730</b>	25x2,3/68 1x10W/m	-	150	<sup>m</sup> <sub>H1</sub>	<b>49,23</b>
<b>1095731</b>	32x2,9/68 1x10W/m	-	150	<sup>m</sup> <sub>H1</sub>	<b>54,74</b>
<b>1095734</b>	40x3,7/140 1x10W/m	-	150	<sup>m</sup> <sub>H1</sub>	<b>64,57</b>
<b>1095736</b>	50x4,6/140 1x10W/m	-	150	<sup>m</sup> <sub>H1</sub>	<b>69,19</b>
<b>1095737</b>	63x5,8/140 1x10W/m	-	150	<sup>m</sup> <sub>H1</sub>	<b>71,90</b>
<b>1095738</b>	75x6,8/175 1x10W/m	-	150	<sup>m</sup> <sub>H1</sub>	<b>89,82</b>
<b>1095739</b>	90x8,2/200 1x10W/m	-	100	<sup>m</sup> <sub>H1</sub>	<b>119,65</b>
<b>1095740</b>	110x10,0/200 1x10W/m	-	100	<sup>m</sup> <sub>H1</sub>	<b>130,31</b>

### Uponor Ecoflex Supra PLUS Set

 <b>1120124</b>	25+32/68	-	1	Set H2	<b>385,42</b>
<b>1120126</b>	40+50+63/140	-	1	Set H2	<b>427,83</b>
<b>1120127</b>	75/175	-	1	Set H2	<b>495,03</b>
<b>1120128</b>	90+110/200	-	1	Set H2	<b>542,14</b>

### Uponor Ecoflex Supra PLUS Regler 150

 <b>1120123</b>			50	1	St. H2	<b>341,80</b>
--	--	--	----	---	-----------	---------------

### Uponor Ecoflex Supra PLUS Kabel-Set S1

 <b>1042310</b>				1	St. H2	<b>68,37</b>
--	--	--	--	---	-----------	--------------

### Uponor Ecoflex Supra PLUS Kabel-Set S2

 <b>1042311</b>				1	St. H2	<b>153,22</b>
--	--	--	--	---	-----------	---------------

### Uponor Ecoflex Supra PLUS T-Set

 <b>1061641</b>	140/90/68		5	1	St. H2	<b>553,95</b>
<b>1061642</b>	200/175/140		3	1	St. H2	<b>636,30</b>

### Uponor Ecoflex Reduzierring

 <b>1060991</b>	200/68		8	1	St. H2	<b>10,61</b>
--	--------	--	---	---	-----------	--------------

# Uponor Wipex

Art-Nr.	Dimension	LE	VE	ME RG	Preis/ME
 <b>1018328</b>	25x2,3-G1	40	1	St. H5	<b>52,97</b>
<b>1018329</b>	32x2,9-G1	20	1	St. H5	<b>57,96</b>
<b>1018330</b>	40x3,7-G1 ¼	10	1	St. H5	<b>71,42</b>
<b>1018331</b>	50x4,6-G1 ¼	10	1	St. H5	<b>82,60</b>
<b>1018332</b>	63x5,8-G2	8	1	St. H5	<b>103,90</b>
<b>1018333</b>	75x6,8-G2	6	1	St. H5	<b>141,56</b>
<b>1018334</b>	90x8,2-G3	4	1	St. H5	<b>196,30</b>
<b>1018335</b>	110x10,0-G3	3	1	St. H5	<b>235,56</b>

## Uponor Ecoflex Übergangsnippel PN6

 <b>1078368</b>	125x11,4-R4	-	1	St. H5	<b>381,91</b>
--	-------------	---	---	-----------	---------------

## Uponor Ecoflex Übergangsnippel PN10

 <b>1091505</b>	20x2,8-¾"	10	1	St. H5	<b>50,09</b>
--	-----------	----	---	-----------	--------------

## Uponor Wipex Übergangsnippel PN10

 <b>1018336</b>	25x3,5-G1	40	1	St. H5	<b>54,73</b>
<b>1018338</b>	32x4,4-G1	20	1	St. H5	<b>60,80</b>
<b>1018339</b>	40x5,5-G1 ¼	10	1	St. H5	<b>75,44</b>
<b>1018340</b>	50x6,9-G1 ¼	10	1	St. H5	<b>82,70</b>
<b>1018341</b>	63x8,6-G2	8	1	St. H5	<b>103,52</b>

## Uponor Wipex Kupplung PN6

 <b>1042972</b>	25x2,3-25x2,3	30	1	St. H5	<b>105,43</b>
<b>1042973</b>	32x2,9-32x2,9	25	1	St. H5	<b>114,93</b>
<b>1042980</b>	40x3,7-40x3,7	15	1	St. H5	<b>135,61</b>
<b>1042984</b>	50x4,6-50x4,6	10	1	St. H5	<b>155,84</b>
<b>1042981</b>	63x5,8-63x5,8	5	1	St. H5	<b>196,32</b>
<b>1042985</b>	75x6,8-75x6,8	3	1	St. H5	<b>279,58</b>
<b>1042986</b>	90x8,2-90x8,2	4	1	St. H5	<b>383,11</b>
<b>1042987</b>	110x10-110x10	2	1	St. H5	<b>462,83</b>

## Uponor Ecoflex Kupplung PN6

 <b>1078365</b>	125x11,4-125x11,4	-	1	St. H5	<b>535,41</b>
--	-------------------	---	---	-----------	---------------

## Uponor Wipex Kupplung PN10

 <b>1042970</b>	25x3,5-25x3,5	40	1	St. H5	<b>106,85</b>
<b>1042974</b>	32x4,4-32x4,4	25	1	St. H5	<b>117,20</b>
<b>1042979</b>	40x5,5-40x5,5	15	1	St. H5	<b>138,01</b>
<b>1042983</b>	50x6,9-50x6,9	10	1	St. H5	<b>158,24</b>
<b>1042982</b>	63x8,6-63x8,6	4	1	St. H5	<b>224,86</b>

## Uponor Wipex T-Stück

 <b>1018345</b>	G1-G1-G1	20	1	St. H5	<b>31,66</b>
<b>1018346</b>	G1 ¼-G1 ¼-G1 ¼	10	1	St. H5	<b>42,12</b>
<b>1018347</b>	G2-G2-G2	4	1	St. H5	<b>62,58</b>
<b>1018348</b>	G3-G3-G3	3	1	St. H5	<b>145,16</b>

## Uponor Ecoflex T-Stück

 <b>1078367</b>	Rp4-Rp4-Rp4	-	1	St. H5	<b>168,95</b>
--	-------------	---	---	-----------	---------------

## Uponor Wipex Winkel

 <b>1018350</b>	G1-G1	20	1	St. H5	<b>32,59</b>
<b>1018351</b>	G1 ¼-G1 ¼	15	1	St. H5	<b>34,68</b>
<b>1018352</b>	G2-G2	5	1	St. H5	<b>56,87</b>
<b>1018353</b>	G3-G3	2	1	St. H5	<b>123,72</b>

## Uponor Ecoflex Winkel

 <b>1078366</b>	Rp4-Rp4	-	1	St. H5	<b>167,74</b>
--	---------	---	---	-----------	---------------

## Uponor Wipex Gewindemuffe

 <b>1018355</b>	G1-G1	40	1	St. H5	<b>25,10</b>
<b>1018356</b>	G1 ¼-G1 ¼	25	1	St. H5	<b>30,57</b>
<b>1018357</b>	G2-G2	15	1	St. H5	<b>47,12</b>
<b>1018358</b>	G3-G3	10	1	St. H5	<b>77,57</b>

# Uponor Wipex

Art-Nr.	Dimension	LE	VE	ME RG	Preis/ME
 <b>1018368</b>	G1 ¼-G1	25	1	St. H5	<b>22,84</b>
<b>1018369</b>	G1 ½-G1 ¼	25	1	St. H5	<b>52,00</b>
<b>1018371</b>	G2-G1	15	1	St. H5	<b>73,41</b>
<b>1018372</b>	G2-G1 ¼	15	1	St. H5	<b>68,53</b>
<b>1018373</b>	G2 ½-G2	6	1	St. H5	<b>120,14</b>
<b>1018374</b>	G3-G1	6	1	St. H5	<b>120,17</b>
<b>1018375</b>	G3-G1 ¼	10	1	St. H5	<b>124,90</b>
<b>1018376</b>	G3-G2	10	1	St. H5	<b>126,08</b>
<b>1009052</b>	G4-G3	6	1	St. H5	<b>167,73</b>

## Uponor Ecoflex Reduzierung

 <b>1078369</b>	R4-G3	6	1	St. H5	<b>127,30</b>
--	-------	---	---	-----------	---------------

## Uponor Wipex Gewindeflansch

 <b>1018359</b>	F25/4-85/G1	10	1	St. H5	<b>145,13</b>
<b>1018360</b>	F32/4-100/G1 ¼	5	1	St. H5	<b>179,63</b>
<b>1018361</b>	F40/4-110/G1 ½	5	1	St. H5	<b>195,30</b>
<b>1018362</b>	F50/4-125/G2	4	1	St. H5	<b>271,26</b>
<b>1018363</b>	F65/8-145/2 ½	3	1	St. H5	<b>347,41</b>
<b>1018364</b>	F80/8-160/G3	3	1	St. H5	<b>368,84</b>
<b>1018365</b>	F100/8-180/G4	3	1	St. H5	<b>491,38</b>

## Uponor Ecoflex Gewindeflansch

 <b>1078370</b>	F100/8-180/Rp4	-	1	St. H5	<b>246,28</b>
--	----------------	---	---	-----------	---------------

## Uponor Wipex Drehnippel

 <b>1045455</b>	G1	20	1	St. H5	<b>66,04</b>
<b>1045456</b>	G1 ¼-G1	20	1	St. H5	<b>68,53</b>
<b>1045457</b>	G1 ¼	15	1	St. H5	<b>72,82</b>
<b>1065442</b>	G1¼ 120mm	8	1	St. H5	<b>96,86</b>
<b>1045458</b>	G2-G1 ¼	10	1	St. H5	<b>108,76</b>
<b>1045459</b>	G2	10	1	St. H5	<b>111,96</b>
<b>1065444</b>	G2 120mm	3	1	St. H5	<b>145,14</b>
<b>1045460</b>	G3-G2	3	1	St. H5	<b>221,26</b>
<b>1045461</b>	G3	2	1	St. H5	<b>374,79</b>

Art-Nr.	Dimension	LE	VE	ME RG	Preis/ME
 <b>1018302</b>	G1	30	1	St. H5	<b>62,11</b>
<b>1018303</b>	G1 ¼	10	1	St. H5	<b>78,89</b>
<b>1018304</b>	G2	5	1	St. H5	<b>127,28</b>
<b>1018305</b>	G3	5	1	St. H5	<b>240,35</b>

## Uponor Ecoflex Anschweißkupplung ST PN6 EU+GOST

 <b>1094013</b>	25x2,3-26,9	-	1	St. H5	<b>96,96</b>
<b>1094014</b>	32x2,9-33,7	-	1	St. H5	<b>105,70</b>
<b>1094015</b>	40x3,7-42,4	-	1	St. H5	<b>124,77</b>
<b>1094016</b>	50x4,6-48,3	-	1	St. H5	<b>143,38</b>
<b>1094017</b>	63x5,8-60,3	-	1	St. H5	<b>180,61</b>
<b>1094018</b>	75x6,8-76,1	-	1	St. H5	<b>257,23</b>
<b>1094019</b>	90x8,2-88,9	-	1	St. H5	<b>352,48</b>
<b>1094020</b>	110x10,0-114,3	-	1	St. H5	<b>425,78</b>
<b>1094021</b>	125x11,4-114,3	-	1	St. H5	<b>649,13</b>

## Uponor Wipex - MLC Presskupplung S-Press PN6

 <b>1060058</b>	32x2,9-32x3,0	25	1	St. H5	<b>87,93</b>
---	---------------	----	---	-----------	--------------

## Uponor Wipex - MLC Presskupplung S-Press PN6

 <b>1060059</b>	40x3,7-40x4,0	15	1	St. H5	<b>104,94</b>
<b>1060060</b>	50x4,6-50x4,5	10	1	St. H5	<b>151,10</b>

## Uponor Wipex RS Adapter PN6

 <b>1047013</b>	DR 63x5,8 RS2	240	1	St. H5	<b>103,40</b>
--	---------------	-----	---	-----------	---------------

## Uponor Wipex Aufspreizange

 <b>1046407</b>	1 - 1 ½	25	1	St. NET	<b>35,20</b>
--	---------	----	---	------------	--------------



# Uponor Q&E

Art-Nr.	Dimension	LE	VE	ME RG	Preis/ME
---------	-----------	----	----	----------	----------

## Uponor Q&E Sicherungsring white

 1057455	25	300	20	St. F1	1,11
1057456	32	150	10	St. F1	2,10

## Uponor Q&E Ring natural

 1045464	40	80	5	St. H3	3,25
1045489	50	70	5	St. H3	4,55
1045490	63	35	5	St. H3	7,16
1085087	75	18	2	St. H3	15,68

## Uponor Q&E Winkel PPSU

 1008681	25-25	25	5	St. H3	10,92
1001245	32-32	10	1	St. H3	21,83
1008683	40-40	10	1	St. H3	34,24
1042859	50-50	5	1	St. H3	54,67
1042858	63-63	3	1	St. H3	81,92
1085080	75-75	2	1	St. H3	130,58

## Uponor Q&E Kupplung PPSU

 1008671	25-25	50	5	St. H3	8,64
1001235	32-32	15	1	St. H3	13,39
1008673	40-40	10	1	St. H3	26,07
1042866	50-50	10	1	St. H3	39,07
1042865	63-63	5	1	St. H3	67,81
1085084	75-75	10	1	St. H3	130,58

## Uponor Q&E Reduzierkupplung PPSU

 1001240	32-25	20	1	St. H3	20,21
1008678	40-32	10	1	St. H3	26,07
1042879	50-32	10	1	St. H3	39,07
1042867	50-40	10	1	St. H3	39,07
1042878	63-40	5	1	St. H3	67,03
1042877	63-50	5	1	St. H3	65,18
1085086	75-50	10	1	St. H3	130,19
1085085	75-63	10	1	St. H3	130,58

## Uponor Q&E T-Stück PPSU

 1008686	25-25-25	20	5	St. H3	13,77
1001250	32-32-32	10	1	St. H3	28,00
1008688	40-40-40	5	1	St. H3	45,64
1042861	50-50-50	3	1	St. H3	78,13
1042860	63-63-63	2	1	St. H3	104,24
1085081	75-75-75	2	1	St. H3	156,69

Art-Nr.	Dimension	LE	VE	ME RG	Preis/ME
---------	-----------	----	----	----------	----------

## Uponor Q&E Reduzier-T-Stück PPSU

 1008712	25-32-25	15	1	St. H3	28,00
1001426	32-25-25	15	1	St. H3	28,00
1001428	32-25-32	15	1	St. H3	28,00
1008713	32-40-32	10	1	St. H3	50,68
1008708	40-25-32	5	1	St. H3	50,68
1008695	40-25-40	5	1	St. H3	50,68
1008709	40-32-32	5	1	St. H3	50,68
1008696	40-32-40	5	1	St. H3	50,68
1042876	50-25-40	4	1	St. H3	78,13
1042864	50-25-50	4	1	St. H3	78,13
1042863	50-32-50	4	1	St. H3	78,13
1042862	50-40-40	4	1	St. H3	78,13
1042875	50-40-50	4	1	St. H3	78,13
1042871	63-25-50	2	1	St. H3	108,87
1042873	63-25-63	2	1	St. H3	108,87
1042870	63-32-63	2	1	St. H3	108,87
1042869	63-40-40	2	1	St. H3	108,87
1042872	63-40-63	2	1	St. H3	108,87
1042868	63-50-50	2	1	St. H3	108,87
1042874	63-50-63	2	1	St. H3	108,87
1085083	75-25-75	4	1	St. H3	156,22
1085082	75-40-75	4	1	St. H3	156,22

## Uponor Q&E Übergangsnippel PL

 1023007	25-R $\frac{3}{4}$ "MT	70	5	St. H3	19,53
1047191	32-R1"MT	10	1	St. H3	32,59

## Uponor Q&E Übergangsnippel PL/DR

 1085077	40-R1 $\frac{1}{4}$ "MT	16	1	St. H3	52,13
1085076	50-R1 $\frac{1}{2}$ "MT	8	1	St. H3	65,18
1085075	63-R2"MT	6	1	St. H3	97,67
1085074	75-R2 $\frac{1}{2}$ "MT	6	1	St. H3	189,61

## Uponor Q&E Winkel mit Innengewinde PL

 1023026	25-G $\frac{3}{4}$ "FT	35	5	St. H3	19,53
---	------------------------	----	---	-----------	-------

## Uponor Q&E Übergangsmuffe PL

 1023012	25-Rp $\frac{3}{4}$ "FT	40	5	St. H3	19,53
---	-------------------------	----	---	-----------	-------

# Uponor Ecoflex Systemzubehör

Art-Nr.	Dimension	LE	VE	ME RG	Preis/ME
<b>Uponor Ecoflex Gummi-Endkappe, Single</b>					
 <b>1018316</b>	25+32+40/68	-	1	St. H2	<b>26,69</b>
<b>1018246</b>	25+32+40/90	-	1	St. H2	<b>32,29</b>
<b>1018315</b>	25+28+32/140	-	1	St. H2	<b>34,41</b>
<b>1018313</b>	32+40+50/175	-	1	St. H2	<b>46,68</b>
<b>1018314</b>	40+50+63/140	-	1	St. H2	<b>38,78</b>
<b>1095801</b>	63+75+90/140	-	1	St. H2	<b>44,94</b>
<b>1018312</b>	63+75/175	-	1	St. H2	<b>50,56</b>
<b>1018310</b>	75+90+110/200	-	1	St. H2	<b>66,59</b>
<b>1018311</b>	90+110/175	-	1	St. H2	<b>64,47</b>
<b>1067757</b>	125/200	-	1	St. H2	<b>79,80</b>

## Uponor Ecoflex Gummi-Endkappe, Twin

 <b>1119374</b>	18-22+25-28+32/140	-	1	St. H2	<b>47,78</b>
<b>1018245</b>	25+32+40/140	-	1	St. H2	<b>54,81</b>
<b>1018309</b>	25+32+40/175	-	1	St. H2	<b>67,42</b>
<b>1018308</b>	25+32+50/175	-	1	St. H2	<b>69,78</b>
<b>1018307</b>	40+50+63/200	-	1	St. H2	<b>72,01</b>
<b>1088979</b>	75+90/250	-	1	St. H2	<b>89,22</b>

## Uponor Ecoflex Gummi-Endkappe, Quattro

 <b>1086838</b>	20+25+32/140	-	1	St. H2	<b>81,09</b>
<b>1018306</b>	18-32+25-32/175	-	1	St. H2	<b>81,09</b>
<b>1094252</b>	25+32+40/175	-	1	St. H2	<b>87,45</b>
<b>1034308</b>	18-28+32+40/200	-	1	St. H2	<b>123,74</b>

## Uponor Ecoflex T-Isoliersatz

 <b>1060986</b>	140/90/68	5	1	St. H2	<b>373,96</b>
<b>1060982</b>	200/175/140	4	1	St. H2	<b>440,80</b>

## Uponor Ecoflex Eckisoliersatz

 <b>1060985</b>	200/175/140	3	1	St. H2	<b>345,00</b>
--	-------------	---	---	-----------	---------------

Art-Nr.	Dimension	LE	VE	ME RG	Preis/ME
<b>Uponor Ecoflex Längsisoliersatz</b>					
 <b>1060984</b>	200/175/140	6	1	St. H2	<b>341,79</b>

## Uponor Ecoflex Reduzierring

 <b>1060991</b>	200/68	8	1	St. H2	<b>10,61</b>
<b>1060990</b>	200/90	8	1	St. H2	<b>15,26</b>
<b>1085107</b>	200/160	12	1	St. H2	<b>14,73</b>

## Uponor Ecoflex Mantelrohr-Verbindungsset

 <b>1084574</b>	175+200	10	1	St. H2	<b>134,36</b>
<b>1083872</b>	250	9	1	St. H2	<b>136,71</b>

## Uponor Ecoflex H-Isoliersatz

 <b>1007355</b>	200/175/140	-	1	St. H2	<b>742,45</b>
--	-------------	---	---	-----------	---------------

## Uponor Ecoflex Schacht

 <b>1018326</b>	6x140/145/175/200	-	3	St. H2	<b>1119,66</b>
<b>1018327</b>	8x140/145/175/200	-	3	St. H2	<b>1190,17</b>
<b>1084576</b>	2x250-6x140/175/200	-	1	St. H2	<b>1614,75</b>
<b>1084577</b>	4x250-4x140/175/200	-	1	St. H2	<b>2472,40</b>
<b>1084578</b>	6x250-2x140/175/200	-	1	St. H2	<b>2864,07</b>

## Uponor Ecoflex Dichtband

 <b>1018382</b>	50mm x 10m	-	1	St. H2	<b>105,25</b>
--	------------	---	---	-----------	---------------

## Uponor Ecoflex Schrumpfschlauch

 <b>1018379</b>	140	-	1	St. H2	<b>34,53</b>
<b>1018380</b>	175/200	-	1	St. H2	<b>38,66</b>
<b>1084575</b>	250	15	1	St. H2	<b>72,83</b>

## Uponor Ecoflex Hauseinführungsbogen Single

 <b>1118765</b>	50x4,6/140	-	1	St. H2	<b>472,15</b>
<b>1118766</b>	63x5,8/140	-	1	St. H2	<b>494,91</b>
<b>1118767</b>	75x6,8/140	-	1	St. H2	<b>830,52</b>

Lieferzeit auf Anfrage.

# Uponor Ecoflex Systemzubehör

INHALT

Installation

Flächenheizung  
und -kühlungNahwärme-  
versorgung

Werkzeuge

Anhang

Art-Nr.	Dimension	LE	VE	ME RG	Preis/ME
 <b>1118771</b>	2x25x2,3/140	-	1	St. H2	<b>432,33</b>
<b>1118772</b>	2x32x2,9/140	-	1	St. H2	<b>455,08</b>
<b>1118773</b>	2x40x3,7/160	-	1	St. H2	<b>534,72</b>
<b>1118774</b>	2x50x4,6/200	-	1	St. H2	<b>655,78</b>
<b>1118775</b>	2x63x5,8/200	-	1	St. H2	<b>830,52</b>
<b>1118776</b>	2x75x6,8/250	-	1	St. H2	<b>1114,95</b>

Lieferzeit auf Anfrage.

## Uponor Ecoflex Mauerdurchführung DWD

 <b>1007358</b>	68	-	1	St. H2	<b>236,88</b>
<b>1007359</b>	90	-	1	St. H2	<b>274,60</b>
<b>1007360</b>	140	-	1	St. H2	<b>312,32</b>
<b>1007361</b>	175	-	1	St. H2	<b>405,43</b>
<b>1007362</b>	200	-	1	St. H2	<b>522,15</b>
<b>1091429</b>	250	-	1	St. H2	<b>586,94</b>

## Uponor Ecoflex Ergänzungssatz NDW

 <b>1007365</b>	140	-	1	St. H2	<b>183,85</b>
<b>1007366</b>	175	-	1	St. H2	<b>222,73</b>
<b>1007367</b>	200	-	1	St. H2	<b>330,02</b>
<b>1091430</b>	250	-	1	St. H2	<b>398,35</b>

## Uponor Ecoflex Faserzementrohr DWD

 <b>1007368</b>	68	-	1	St. H2	<b>168,54</b>
<b>1007370</b>	140	-	1	St. H2	<b>173,26</b>
<b>1007371</b>	175	-	1	St. H2	<b>198,00</b>
<b>1007372</b>	200	-	1	St. H2	<b>272,25</b>
<b>1091431</b>	250	-	1	St. H2	<b>327,66</b>

## Uponor Ecoflex Epoxidharz Set für DWD

 <b>1007373</b>	1,1 kg/3,5m <sup>2</sup>	-	1	Set H2	<b>122,56</b>
--	--------------------------	---	---	-----------	---------------

## Uponor Ecoflex Mauerdurchführung NDW

 <b>1018267</b>	68+90	-	1	St. H2	<b>46,20</b>
<b>1018269</b>	140	-	1	St. H2	<b>50,91</b>
<b>1018268</b>	175+200	-	1	St. H2	<b>56,33</b>
<b>1083871</b>	250	16	1	St. H2	<b>98,78</b>

Art-Nr.	Dimension	LE	VE	ME RG	Preis/ME
 <b>1034202</b>	140	40	1	St. H2	<b>56,33</b>
<b>1034203</b>	175	30	1	St. H2	<b>59,17</b>
<b>1034204</b>	200	20	1	St. H2	<b>67,85</b>
<b>1090415</b>	250	-	1	St. H2	<b>90,52</b>

## Uponor Ecoflex Schrumpfmanschette

 <b>1036014</b>	140+175+200-700mm	-	1	St. H2	<b>301,70</b>
--	-------------------	---	---	-----------	---------------

## Uponor Ecoflex Schrumpfband

 <b>1093120</b>	160mm x 10m	30	1	St. H2	<b>138,50</b>
--	-------------	----	---	-----------	---------------

## Uponor Ecoflex Trassenwarnband, rot

 <b>1018385</b>	40mm x 250m	-	1	St. H2	<b>54,34</b>
<b>1105785</b>	40mm x 30m	-	1	St. H2	<b>19,35</b>

## Uponor Ecoflex Abroller

 <b>1036645</b>		-	1	St. NET	<b>2000,88</b>
--	--	---	---	------------	----------------

## Uponor Ecoflex Stationäre Abrollvorrichtung

 <b>1119057</b>	< 600kg	-	1	St. NET	<b>3298,63</b>
--	---------	---	---	------------	----------------

Lieferzeit auf Anfrage.

## Uponor Multi Rohrschneider

 <b>1089677</b>	32-40	12	1	St. NET	<b>85,66</b>
<b>1089779</b>	32-40 Ersatzklinge	50	1	St. NET	<b>41,33</b>

## Uponor Flex Rohrschneider PEX

 <b>1095265</b>	50-63	12	1	St. NET	<b>104,17</b>
<b>1095266</b>	50+63 Ersatzklinge	50	1	St. NET	<b>49,77</b>

## Uponor Multi Rohrschneider

 <b>1089675</b>	25-63	12	1	St. NET	<b>81,70</b>
<b>1089777</b>	25-63 Ersatzschneidrad	50	1	St. NET	<b>9,43</b>

# Uponor Ecoflex Systemzubehör

Art-Nr.	Dimension	LE	VE	ME RG	Preis/ME
<b>Uponor Multi Rohrschneider</b>					
 <b>1089676</b>	50-125	8	1	St. NET	<b>152,56</b>
<b>1089778</b>	50-125 Ersatzschneidrad	50	1	St. NET	<b>11,72</b>

## Uponor MLC Universalentgrater

 <b>1060167</b>		50	1	St. NET	<b>17,42</b>
--	--	----	---	------------	--------------

## Uponor Wipex Aufspreizange

 <b>1046407</b>	1 - 1 ½	25	1	St. NET	<b>35,20</b>
--	---------	----	---	------------	--------------

## Uponor Q&E Grafitpaste

 <b>1005017</b>	100g	-	1	St. NET	<b>26,19</b>
--	------	---	---	------------	--------------

## Uponor Ecoflex Dichtpaste

 <b>1060996</b>	290ml	-	1	St. H2	<b>19,00</b>
--	-------	---	---	-----------	--------------

Art-Nr.	Dimension	LE	VE	ME RG	Preis/ME
<b>Uponor Ecoflex Spreiznieten</b>					
 <b>1021997</b>		-	1	St. H2	<b>0,28</b>

## Uponor Ecoflex Schrauben-Set

 <b>1021999</b>		-	1	St. H2	<b>0,95</b>
--	--	---	---	-----------	-------------

## Uponor Ecoflex Schrauben-Set

 <b>1060995</b>	M6x30 (34pcs)	-	1	St. H2	<b>17,60</b>
--	---------------	---	---	-----------	--------------

## Uponor Ecoflex Supra PLUS Frostschutzkabel

 <b>1044136</b>	10W/m	-	1	m H2	<b>20,09</b>
--	-------	---	---	---------	--------------

# Uponor Ecoflex Mietwerkzeuge

## Uponor RNT Ecoflex Aufweitwerkzeug rent DACH Q&E

 <b>1087649</b>	M18 6BAR 25/32/40	-	1	St. NET	<b>a.A.</b>
--	-------------------	---	---	------------	-------------

## Uponor RNT Ecoflex Abroller rent DACH

 <b>1087652</b>	type 1	-	1	St. NET	<b>a.A.</b>
--	--------	---	---	------------	-------------

## Uponor RNT Ecoflex Aufweitwerkzeug rent DACH Q&E

 <b>1087650</b>	M18 10BAR 25/32	-	1	St. NET	<b>a.A.</b>
--	-----------------	---	---	------------	-------------

## Uponor Ecoflex Rundungswerkz. rent DACH

 <b>1085661</b>	125	-	1	St. NET	<b>a.A.</b>
--	-----	---	---	------------	-------------

## Uponor RNT Ecoflex Aufweitwerkzeug rent DACH Q&E

 <b>1087651</b>	M18 VLD 40-75	-	1	St. NET	<b>a.A.</b>
--	---------------	---	---	------------	-------------

# Werkzeuge

Art-Nr.	Dimension	LE	VE	ME RG	Preis/ME
---------	-----------	----	----	----------	----------

## Abrollen

### Uponor MLC Rohrrichter



1010512	14-25	60	1	St. NET	498,54
---------	-------	----	---	------------	--------

### Uponor Multi Teleskop-Abrollvorrichtung



1058662		-	1	St. NET	479,30
---------	--	---	---	------------	--------

### Uponor Multi Abrollvorrichtung



1006255	120-960M	-	1	St. NET	592,90
---------	----------	---	---	------------	--------

### Uponor Magna Abrollvorrichtung



1006256	25-640m	-	1	St. NET	1119,90
---------	---------	---	---	------------	---------

### Uponor Ecoflex Stationäre Abrollvorrichtung



1119057	< 600kg	-	1	St. NET	3298,63
---------	---------	---	---	------------	---------

Lieferzeit auf Anfrage.

### Uponor Wipex Aufspreizzange



1046407	1 - 1 ½	25	1	St. NET	35,20
---------	---------	----	---	------------	-------

1046408	1 ½ - 3 ½	25	1	St. NET	39,16
---------	-----------	----	---	------------	-------

Art-Nr.	Dimension	LE	VE	ME RG	Preis/ME
---------	-----------	----	----	----------	----------

## Vorbereitung, Schneiden, Biegen

### Uponor Multi Rohrschneider



1089674	12-25	36	1	St. NET	94,31
---------	-------	----	---	------------	-------

1089776	12-25 Ersatzklinge	150	1	St. NET	20,55
---------	--------------------	-----	---	------------	-------

### Uponor Multi Rohrschneider



1089677	32-40	12	1	St. NET	85,66
---------	-------	----	---	------------	-------

1089779	32-40 Ersatzklinge	50	1	St. NET	41,33
---------	--------------------	----	---	------------	-------

### Uponor Flex Rohrschneider PEX



1095265	50-63	12	1	St. NET	104,17
---------	-------	----	---	------------	--------

1095266	50+63 Ersatzklinge	50	1	St. NET	49,77
---------	--------------------	----	---	------------	-------

### Uponor Multi Rohrschneider



1089675	25-63	12	1	St. NET	81,70
---------	-------	----	---	------------	-------

1089777	25-63 Ersatzschneidrad	50	1	St. NET	9,43
---------	------------------------	----	---	------------	------

### Uponor Multi Rohrschneider



1089676	50-125	8	1	St. NET	152,56
---------	--------	---	---	------------	--------

1089778	50-125 Ersatzschneidrad	50	1	St. NET	11,72
---------	-------------------------	----	---	------------	-------

### Uponor Flex Rohrschneider PEX



1089673	12-25	36	1	St. NET	30,26
---------	-------	----	---	------------	-------

1089780	12-25 Ersatzklinge	150	1	St. NET	20,55
---------	--------------------	-----	---	------------	-------

### Uponor MLC Ersatzschneidrad



1006635	25-63	1000	1	St. NET	9,43
---------	-------	------	---	------------	------

1014173	50-110	20	1	St. NET	11,35
---------	--------	----	---	------------	-------

### Uponor MLC Rohrabschneider und Entgrater



1014334	63-110	32	1	St. NET	672,74
---------	--------	----	---	------------	--------

1014320	63-110 Ersatzschneidrad	100	1	St. U2	76,17
---------	-------------------------	-----	---	-----------	-------

# Werkzeuge

Art-Nr.	Dimension	LE	VE	ME RG	Preis/ME
---------	-----------	----	----	----------	----------

## Vorbereitung, Schneiden, Biegen

### Uponor MLC Entgrater

 <b>1006952</b>	14	50	1	St. NET	<b>31,22</b>
<b>1006830</b>	16	50	1	St. NET	<b>32,80</b>
<b>1015749</b>	20	1200	1	St. NET	<b>35,93</b>
<b>1015756</b>	25	960	1	St. NET	<b>37,97</b>
<b>1015762</b>	32	900	1	St. NET	<b>41,33</b>

### Uponor MLC Entgrater

 <b>1006638</b>	40	600	1	St. NET	<b>42,52</b>
<b>1015808</b>	50	600	1	St. NET	<b>50,45</b>
<b>1014339</b>	63	600	1	St. NET	<b>61,85</b>
<b>1014344</b>	75	600	1	St. NET	<b>91,66</b>

### Uponor MLC Kombientgrater

 <b>1015739</b>	16/20/25	60	1	St. NET	<b>57,18</b>
--	----------	----	---	------------	--------------

### Uponor MLC Universalentgrater

 <b>1060167</b>		50	1	St. NET	<b>17,42</b>
--	--	----	---	------------	--------------

Art-Nr.	Dimension	LE	VE	ME RG	Preis/ME
---------	-----------	----	----	----------	----------

### Uponor MLC Biegefeder innen

 <b>1013727</b>	14	1000	1	St. NET	<b>12,43</b>
<b>1013729</b>	16	100	1	St. NET	<b>13,21</b>
<b>1013734</b>	20	75	1	St. NET	<b>16,82</b>
<b>1013737</b>	25	50	1	St. NET	<b>17,12</b>
<b>1013739</b>	32	40	1	St. NET	<b>25,83</b>

### Uponor MLC Biegefeder außen

 <b>1006639</b>	14	550	1	St. NET	<b>15,32</b>
<b>1006640</b>	16	55	1	St. NET	<b>16,57</b>
<b>1013792</b>	20	45	1	St. NET	<b>21,09</b>
<b>1013794</b>	25	45	1	St. NET	<b>21,56</b>

### Uponor Uni Pipe PLUS Biegezange

 <b>1071925</b>	16-32	100	1	St. NET	<b>497,34</b>
--	-------	-----	---	------------	---------------

### Uponor Uni Pipe PLUS Biegesegment

 <b>NEU</b> <b>1120408</b>	R32 16	10	1	St. NET	<b>100,00</b>
<b>NEU</b> <b>1120409</b>	R40 20	10	1	St. NET	<b>100,00</b>
<b>NEU</b> <b>1120410</b>	R62,5 25	10	1	St. NET	<b>100,00</b>
<b>NEU</b> <b>1120411</b>	R80 32	10	1	St. NET	<b>230,00</b>

### Uponor MLC Biegezange

 <b>OUT</b> <b>1013773</b>	16-32	48	1	St. NET	<b>461,29</b>
---	-------	----	---	------------	---------------

Lieferung solange Vorrat reicht. Artikel läuft im Laufe des Jahres aus.

### Uponor RTM Kombikalibrierer

 <b>1048606</b>	16/20/25	20	1	St. NET	<b>6,48</b>
--	----------	----	---	------------	-------------

# Werkzeuge

Art-Nr.	Dimension	LE	VE	ME RG	Preis/ME
---------	-----------	----	----	----------	----------

## Pressen

### Uponor S-Press Handzange ohne Wechseleinsätze

 <b>1015764</b>	14-20	100	1	St. NET	<b>395,70</b>
--	-------	-----	---	------------	---------------

### Uponor S-Press Wechseleinsätze

 <b>1015776</b>	14	400	1	St. NET	<b>61,75</b>
<b>1015777</b>	16	50	1	St. NET	<b>61,75</b>
<b>1015780</b>	20	50	1	St. NET	<b>61,75</b>

### Uponor S-Press Akkumaschine UP 110 ohne Pressbacken

 <b>1083612</b>		20	1	Set NET	<b>1982,03</b>
--	--	----	---	------------	----------------

### Uponor S-Press Ersatzakku UP 110

 <b>1083608</b>		10	1	St. NET	<b>347,19</b>
---	--	----	---	------------	---------------

### Uponor S-Press Ersatzladegerät

 <b>1083610</b>	Mini2, UP110	72	1	St. NET	<b>305,12</b>
--	--------------	----	---	------------	---------------

### Uponor S-Press Werkzeugkoffer UP 110

 <b>1083602</b>		20	1	St. NET	<b>192,18</b>
--	--	----	---	------------	---------------

### Uponor S-Press Maschine EL UP 75 ohne Pressbacken

 <b>1007082</b>		20	1	St. NET	<b>1297,43</b>
--	--	----	---	------------	----------------

### Uponor S-Press Ersatzakku UP 75

 <b>1006949</b>		12	1	St. NET	<b>213,83</b>
--	--	----	---	------------	---------------

### Uponor S-Press Ersatzladegerät Mini UP 75

 <b>1006950</b>		10	1	St. NET	<b>210,00</b>
--	--	----	---	------------	---------------

### Uponor S-Press Werkzeugkoffer blau UP 75

 <b>1084676</b>		20	1	St. NET	<b>224,65</b>
--	--	----	---	------------	---------------

Art-Nr.	Dimension	LE	VE	ME RG	Preis/ME
---------	-----------	----	----	----------	----------

### Uponor S-Press Pressbacken UPP1

 <b>1007083</b>	14	280	1	St. NET	<b>159,74</b>
<b>1007084</b>	16	216	1	St. NET	<b>159,74</b>
<b>1007086</b>	20	-	1	St. NET	<b>159,74</b>
<b>1007087</b>	25	-	1	St. NET	<b>159,74</b>
<b>1007088</b>	32	-	1	St. NET	<b>159,74</b>

### Uponor S-Press Pressbacken UPP1

 <b>1015768</b>	40	108	1	St. NET	<b>205,40</b>
<b>1015792</b>	50	108	1	St. NET	<b>213,83</b>

### Uponor S-Press Basispressbacke

 <b>1046545</b>	63-110	-	1	St. NET	<b>465,00</b>
--	--------	---	---	------------	---------------

### Uponor S-Press Pressschlinge

 <b>1046541</b>	63	72	1	St. NET	<b>790,00</b>
<b>1046542</b>	75	72	1	St. NET	<b>962,24</b>
<b>1046543</b>	90	72	1	St. NET	<b>1273,36</b>
<b>1046544</b>	110	54	1	St. NET	<b>1357,46</b>



# Werkzeuge

Art-Nr.	Dimension	LE	VE	ME RG	Preis/ME
---------	-----------	----	----	----------	----------

## Pressen

### Uponor S-Press Akkumaschine Mini<sup>2</sup> mit KSP0 Pressbacken



1083586	16/20/25/32	30	1	Set NET	1957,86
---------	-------------	----	---	------------	---------

### Uponor S-Press Akkumaschine Mini<sup>2</sup> mit KSP0 Pressbacken



1083594	16/20/25	25	1	Set NET	1778,02
---------	----------	----	---	------------	---------

### Uponor S-Press Akkumaschine Mini<sup>2</sup>



1087260		-	1	St. NET	948,89
---------	--	---	---	------------	--------

### Uponor S-Press Ersatzakku Mini<sup>2</sup>



1083605		48	1	St. NET	290,72
---------	--	----	---	------------	--------

### Uponor S-Press Ersatzladegerät



1083610	Mini2, UP110	72	1	St. NET	305,12
---------	--------------	----	---	------------	--------

### Uponor S-Press Ersatzakku Mini



1015703		120	1	St. NET	215,05
---------	--	-----	---	------------	--------

### Uponor S-Press Werkzeugkoffer Mini2



1083599		25	1	St. NET	102,12
---------	--	----	---	------------	--------

### Uponor S-Press Pressbacken Mini KSP0



1007090	14	5	1	St. NET	186,19
1007091	16	5	1	St. NET	186,19
1007093	20	5	1	St. NET	186,19
1007094	25	5	1	St. NET	186,19
1007095	32	5	1	St. NET	186,19

Art-Nr.	Dimension	LE	VE	ME RG	Preis/ME
---------	-----------	----	----	----------	----------

# Werkzeuge

Art-Nr.	Dimension	LE	VE	ME RG	Preis/ME
---------	-----------	----	----	----------	----------

## Aufweiten

### Uponor Minitec Aufweitwerkzeug



1006247	9,9x1,1	11	1	Set NET	345,97
---------	---------	----	---	------------	--------

### Uponor Q&E Aufweitwerkzeug mit Aufweitk. M12



1063112	6BAR 9,9/20	-	1	Set NET	585,05
1057166	16/20/25 6bar	-	1	Set NET	743,75

### Uponor Q&E Aufweitwerkzeug mit Aufweitk. M12/



<b>NEU</b>	1119375	6bar 9,9RS/20	-	1	Set NET	608,00
<b>NEU</b>	1119376	16RS/20/25 6bar	-	1	Set NET	733,00

**NEU** ab 01.06.2022

### Uponor Q&E Aufweitkopf M12/Rapid Seal



<b>NEU</b>	1119380	9,9x1,1	-	1	St. NET	125,00
------------	---------	---------	---	---	------------	--------

### Uponor Q&E Aufweitkopf M12/M18



1057184	14/15x2,5	-	1	St. NET	135,72
1057172	16x1,8/2,0/2,2	-	1	St. NET	130,94
1057185	17/18x2,5	-	1	St. NET	130,94
1057173	20x1,9/2,0	-	1	St. NET	130,94
1057174	20x2,8	-	1	St. NET	130,94
1057175	25x2,3	-	1	St. NET	130,94
1057176	25x3,5	-	1	St. NET	130,94
1057177	32x2,9	-	1	St. NET	130,94

### Uponor Q&E Aufweitkopf M12/M18/Rapid Seal



<b>NEU</b>	1119381	16x1,8/2,0/2,2	-	1	St. NET	125,00
<b>NEU</b>	1119382	20x1,9/2,0	-	1	St. NET	125,00
<b>NEU</b>	1119383	20x2,8	-	1	St. NET	125,00
<b>NEU</b>	1119384	25x2,3	-	1	St. NET	125,00
<b>NEU</b>	1119385	25x3,5	-	1	St. NET	125,00
<b>NEU</b>	1119386	32x2,9	-	1	St. NET	125,00

**NEU** ab 01.06.2022

Art-Nr.	Dimension	LE	VE	ME RG	Preis/ME
---------	-----------	----	----	----------	----------

### Uponor Q&E Ersatzakku für Aufweitwerkz. M12



1061185	4Ah	12	1	St. NET	130,94
---------	-----	----	---	------------	--------

### Uponor Q&E Aufweitwerkzeug mit Aufweitk. M18 6bar



1063908	16/20/25/32	-	1	Set NET	1299,00
---------	-------------	---	---	------------	---------

### Uponor Q&E Aufweitwerkzeug mit Aufweitk. M18 10bar



1063909	16/20/25/H32	-	1	Set NET	1371,30
---------	--------------	---	---	------------	---------

### Uponor Q&E Aufweitkopf M18 H



1057182	32x2,9/4,4	-	1	St. NET	145,36
1057183	40x3,7	-	1	St. NET	145,36

### Uponor Q&E Aufweitwerkzeug M18 VLD PEX



1085099	40-75	-	1	St. NET	2950,00
---------	-------	---	---	------------	---------

### Uponor Q&E Aufweitkopf VLD



1085095	40x3,7/5,5	-	1	St. NET	572,93
1085096	50x4,6/6,9	-	1	St. NET	586,24
1085097	63x5,8/8,6	-	1	St. NET	618,51
1085098	75x6,8/10,3	-	1	St. NET	661,24

### Uponor Q&E Akku für Aufweitwerkzeug M18 PEX



1085100	5,0Ah	-	1	St. NET	309,95
---------	-------	---	---	------------	--------

### Uponor Q&E Ladegerät Aufweitwerkzeug M12/M18 PEX



1085101	220-240V/50-60Hz	-	1	St. NET	144,61
---------	------------------	---	---	------------	--------

### Uponor Q&E Grafitpaste



1005017	100g	-	1	St. NET	26,19
---------	------	---	---	------------	-------

# Werkzeuge

Art-Nr.	Dimension	LE	VE	ME RG	Preis/ME
---------	-----------	----	----	----------	----------

## Befestigen

### Uponor Multi Rohrhalterung



<b>OUT</b> 1088066		-	1	St. NET	<b>260,00</b>
--------------------	--	---	---	------------	---------------

Lieferung solange Vorrat reicht. Artikel läuft im Laufe des Jahres aus.

### Uponor Siccus 14 Schneidegerät



1006290	14mm 230V	20	1	St. NET	<b>241,47</b>
---------	-----------	----	---	------------	---------------

### Uponor Tacker Werkzeug



1119039	14-20mm	50	1	St. NET	<b>243,06</b>
---------	---------	----	---	------------	---------------

### Uponor Multi Klebebandabroller



1000142		20	1	St. NET	<b>27,40</b>
---------	--	----	---	------------	--------------

### Uponor Classic Clipmaster



1006295	16/17mm l=920mm	100	1	St. NET	<b>220,00</b>
1006309	20mm l=920mm	-	1	St. NET	<b>335,30</b>

### Uponor Classic Ersatzteilst Feder



1007349		-	1	St. U1	<b>8,75</b>
---------	--	---	---	-----------	-------------

### Uponor Classic Drillgerät f.Mattenbinder



1006243	l=320mm	50	1	St. NET	<b>23,18</b>
---------	---------	----	---	------------	--------------

Art-Nr.	Dimension	LE	VE	ME RG	Preis/ME
---------	-----------	----	----	----------	----------

## Sonstige

### Uponor Rapex Press-Backe



1006330	14x2	-	1	St. NET	<b>220,00</b>
1006332	16x2	8	1	St. NET	<b>220,00</b>
1006343	17x2	-	1	St. NET	<b>220,00</b>
1006334	20x2,3	-	1	St. NET	<b>235,00</b>
1006344	25x2,3	-	1	St. NET	<b>235,00</b>

### Uponor Smart Aqua Biegezange für Montageschiene



1015424	2m	100	1	St. NET	<b>150,14</b>
---------	----	-----	---	------------	---------------

# Neu in der Preisliste 2022

Art.-Nr.	Artikel		Seite
1119039	Uponor Tacker Werkzeug	14-20mm	28, 72
1105818	Uponor S-Press PLUS Winkelverschraubg IG	16-G3/4"SN	11
1105819	Uponor S-Press PLUS Winkelverschraubg IG	20-G3/4"SN	11
1119311	Uponor S-Press PLUS Schrägsitzventil	DN 20 20mm	14
1119312	Uponor S-Press PLUS Schrägsitzventil	DN 25 25mm	14
1119313	Uponor S-Press Plus Schrägsitzventil	DN 32 32mm	14
1119314	Uponor S-Press Schrägsitzventil	DN 32 40mm	14
1119315	Uponor S-Press PLUS Schrägsitzventil mit Rückflussverhinderer	DN 20 20mm	14
1119316	Uponor S-Press PLUS Schrägsitzventil mit Rückflussverhinderer	DN 25 25mm	14
1119317	Uponor S-Press PLUS Schrägsitzventil mit Rückflussverhinderer	DN 32 32mm	14
1119318	Uponor S-Press Schrägsitzventil mit Rückflussverhinderer	DN 32 40mm	14
1119319	Uponor S-Press PLUS Zirkulationsventil	DN 20 16mm	14
1119320	Uponor S-Press PLUS Zirkulationsventil	DN 20 20mm	14
1119321	Uponor S-Press PLUS Unterputzventil	DN 15 16mm	14
1119322	Uponor S-Press PLUS Unterputzventil	DN 20 20mm	14
1119323	Uponor S-Press PLUS Unterputzventil	DN 20 25mm	14
1119324	Uponor S-Press PLUS Wasserzählerbox	G2" Coax DN 3/4"	14
1119375	Uponor Q&E Aufweitwerkzeug mit Aufweitk.	M12/ 6bar 9,9RS/20	22, 29, 34, 71
1119376	Uponor Q&E Aufweitwerkzeug mit Aufweitk.	M12/ 16RS/20/25 6bar	71
1119380	Uponor Q&E Aufweitkopf	M12/Rapid Seal 9,9x1.1	71
1119381	Uponor Q&E Aufweitkopf	M12/M18/Rapid Seal 16x1,8/2,0/2,2	71
1119382	Uponor Q&E Aufweitkopf	M12/M18/Rapid Seal 20x1,9/2,0	71
1119383	Uponor Q&E Aufweitkopf	M12/M18/Rapid Seal 20x2,8	71
1119384	Uponor Q&E Aufweitkopf	M12/M18/Rapid Seal 25x2,3	71
1119385	Uponor Q&E Aufweitkopf	M12/M18/Rapid Seal 25x3,5	71
1119386	Uponor Q&E Aufweitkopf	M12/M18/Rapid Seal 32x2,9	71
1120123	Uponor Ecoflex Supra PLUS Regler 150		60
1120124	Uponor Ecoflex Supra PLUS Set	25+32/68	60
1120126	Uponor Ecoflex Supra PLUS Set	40+50+63/140	60
1120127	Uponor Ecoflex Supra PLUS Set	75/175	60
1120128	Uponor Ecoflex Supra PLUS Set	90+110/200	60
1120408	Uponor Uni Pipe PLUS Biegesegment	R32 16	68
1120409	Uponor Uni Pipe PLUS Biegesegment	R40 20	68
1120410	Uponor Uni Pipe PLUS Biegesegment	R62,5 25	68
1120411	Uponor Uni Pipe PLUS Biegesegment	R80 32	68
1120810	Uponor Vario M Füll- und Entleerungsventil		41
1121193	Uponor S-Press PLUS Schallset 2 Wandscheiben	16-20	11
1121194	Uponor S-Press PLUS Schallset U-Wandscheibe	16-20	11
1121195	Uponor S-Press PLUS Montagewinkel	80/150mm	13
1121196	Uponor S-Press PLUS Montagewinkel	100mm	13
1121197	Uponor S-Press PLUS Montageplatte	80/150mm	13
1121531	Uponor Vario M Verteiler - Durchflussmesser	0-5l/min	41
1122372	Uponor Tacker Folie transparent	0,2mm 100x1,03m	27

# Ersetzungen

## Auslaufartikel → → Neue Artikel

Art.-Nr.: Solange Vorrat reicht, Artikel laufen aus:			Art.-Nr.: Neue Artikel		Seite	
1048697	Uponor Ecoflex Supra PLUS Set	25+32/68	1120124	Uponor Ecoflex Supra PLUS Set	25+32/68	60
1048699	Uponor Ecoflex Supra PLUS Set	40+50+63/140	1120126	Uponor Ecoflex Supra PLUS Set	40+50+63/140	60
1048700	Uponor Ecoflex Supra PLUS Set	75/175	1120127	Uponor Ecoflex Supra PLUS Set	75/175	60
1048702	Uponor Ecoflex Supra PLUS Set	90+110/200	1120128	Uponor Ecoflex Supra PLUS Set	90+110/200	60
1060702	Uponor Q&E Aufweitkopf	M12 9,9x1,1	1119380	Uponor Q&E Aufweitkopf	M12/Rapid Seal 9,9x1.1	71
1071674	Uponor Smatrix Wave PLUS Raumfühler D+RH	T-167 grey	1087816	Uponor Smatrix Wave Raumtemperatur-Feuchtefühler	Style T-169	46
1078309	Uponor Fluvia Pumpengruppe	CPG-15-B-W	1119448	Uponor Fluvia Pumpengruppe	CPG-15-D-W	52
1083868	Uponor Ecoflex Thermo	Single 125x11,4/250	1095720	Uponor Ecoflex VIP Thermo	Single 125X11,4/200	58
1086527	Uponor Tacker Folie	0,2mm	1122372	Uponor Tacker Folie transparent	0,2mm 100x1,03m	27
1087163	Uponor Smatrix Base PRO Regelset	X-147 + I-147 Bus 6X	1087161	Uponor Smatrix Base PRO Bedienmodul	I-147 Bus	48
1087379	Uponor Ecoflex Thermo PRO	Single 40X3,7/175	1095714	Uponor Ecoflex VIP Thermo	Single 40X3,7/140	58
1087384	Uponor Ecoflex Thermo PRO	Single 50X4,6/175	1095715	Uponor Ecoflex VIP Thermo	Single 50X4,6/140	58
1087385	Uponor Ecoflex Thermo PRO	Single 63X5,8/175	1095716	Uponor Ecoflex VIP Thermo	Single 63X5,8/140	58
1087388	Uponor Ecoflex Thermo PRO	Single 75X6,8/200	1095717	Uponor Ecoflex VIP Thermo	Single 75X6,8/140	58
1087389	Uponor Ecoflex Thermo PRO	Single 90X8,2/200	1095718	Uponor Ecoflex VIP Thermo	Single 90X8,2/175	58
1087390	Uponor Ecoflex Thermo PRO	Single 110X10,0/200	1095719	Uponor Ecoflex VIP Thermo	Single 110X10,0/175	58
1087393	Uponor Ecoflex Thermo PRO	Twin 2X25X2,3 /175	1118580	Uponor Ecoflex VIP Thermo	Twin 2x25x2,3/140	58
1087395	Uponor Ecoflex Thermo PRO	Twin 2X32X2,9 /175	1118581	Uponor Ecoflex VIP Thermo	Twin 2x32x2,9/140	58
1087396	Uponor Ecoflex Thermo PRO	Twin 2X40X3,7 /175	1118582	Uponor Ecoflex VIP Thermo	Twin 2x40x3,7 /175	58
1087398	Uponor Ecoflex Thermo PRO	Twin 2X50X4,6 /200	1118583	Uponor Ecoflex VIP Thermo	Twin 2x50x4,6/175	58
1087399	Uponor Ecoflex Thermo PRO	Twin 2X63X5,8 /200	1118584	Uponor Ecoflex VIP Thermo	Twin 2x63x5,8/200	58
1088276	Uponor Ecoflex Thermo	Twin 2x75x6,8/250	1118585	Uponor Ecoflex VIP Thermo	Twin 2x75x6,8/250	58
1048703	Uponor Ecoflex Supra PLUS Regler	150	1120123	Uponor Ecoflex Supra PLUS Regler	150	60
1084560	Uponor Fluvia Move PLUS Mischermotor	230V	1119812	Uponor Fluvia Move PLUS Mischermotor	230V	50, 52
1071650	Uponor Smatrix Wave Raumfühler BM	T-163 RAL9010	1086979	Uponor Smatrix Wave Raumfühler BM	T-163 RAL9016	46
1086983	Uponor Smatrix Wave Raumfühler D+RH	T-167 RAL9016	1087816	Uponor Smatrix Wave Raumtemperatur-Feuchtefühler	Style T-169	46

# Artikel laufen aus

Lieferung solange Vorrat reicht, Artikel laufen im Lauf des Jahres aus

Art.-Nr.: Artikel	Seite
<i>Artikelnummern aufsteigend</i>	
1000017 Uponor Multi Folie 4mm 60x1m	37
1005499 Uponor Siccus SW Ständerwandelement 14mm 1150x615mm	35
1030101 Uponor Vario Schrank-Zylinderschloss UP	
1057846 Uponor Smart Aqua Schallset 2 Wandsch.	
1058427 Uponor Base Pumpenrelais X-23 230V	
1061622 Uponor Smart Aqua U-Wand-RTM 20-Rp1/2"FT-20scheibe	
1071651 Uponor Smatrix Base Stern Modul M-141 Bus 8X	
1071686 Uponor Smatrix Base Erweiterungsmodul M-140 Bus 6X	
1071999 Uponor Fluvia T Regelungs-Set Push-12 WL-REC-AC WL-REC-AC	
1072010 Uponor Q&E Kupplung CE PPSU 25-25	
1072023 Uponor Q&E Kupplung CE PPSU 40-40	
1083869 Uponor Ecoflex Gummi-Endkappe Single 90+110+125/250	
1085022 Uponor Siccus Sport Füllmaterial zum Höhenausgleich FIBOPHON 50L	
1085104 Uponor Ecoflex Haus-einführungsbogen Twin 2X50X4,8/205	
1085105 Uponor Ecoflex Haus-einführungsbogen Twin 2X63X5,8/205	
1085106 Uponor Ecoflex Reduzierung 200/205	
1085108 Uponor Ecoflex Haus-einführungsbogen Single 75X6,8/205	
1085820 Uponor Viva Differenzdruckregler Rp1 - G1	
1086978 Uponor Smatrix Base Schaltuhr I-143 Bus RAL9016	
1088066 Uponor Multi Rohrhalterung	26, 72
1088684 Uponor Comfort E AL-Folie Rollmatte 140-1	

Art.-Nr.: Artikel	Seite
1088685 Uponor Comfort E AL-Folie Rollmatte 140-2	
1088686 Uponor Comfort E AL-Folie Rollmatte 140-3	
1088687 Uponor Comfort E AL-Folie Rollmatte 140-4	
1088688 Uponor Comfort E AL-Folie Rollmatte 140-5	
1088689 Uponor Comfort E AL-Folie Rollmatte 140-6	
1088690 Uponor Comfort E AL-Folie Rollmatte 140-7	
1088691 Uponor Comfort E AL-Folie Rollmatte 140-8	
1088692 Uponor Comfort E AL-Folie Rollmatte 140-9	
1088693 Uponor Comfort E AL-Folie Rollmatte 140-10	
1088694 Uponor Comfort E AL-Folie Rollmatte set T-87IF 140-1	
1088695 Uponor Comfort E AL-Folie Rollmatte set T-87IF 140-2	
1088696 Uponor Comfort E AL-Folie Rollmatte set T-87IF 140-3	
1088697 Uponor Comfort E AL-Folie Rollmatte set T-87IF 140-4	
1088698 Uponor Comfort E AL-Folie Rollmatte set T-87IF 140-5	
1088699 Uponor Comfort E AL-Folie Rollmatte set T-87IF 140-6	
1088700 Uponor Comfort E AL-Folie Rollmatte set T-87IF 140-7	
1088701 Uponor Comfort E AL-Folie Rollmatte set T-87IF 140-8	
1088702 Uponor Comfort E AL-Folie Rollmatte set T-87IF 140-9	
1088703 Uponor Comfort E AL-Folie Rollmatte set T-87IF 140-10	
1088707 Uponor Comfort E AL-Folie Isolierung 5mm	
1088822 Uponor Ecoflex Hauseinführungsbogen Twin 2x75x6,8/250	

Fortsetzung siehe nächste Seite

# Artikel laufen aus

Art.-Nr.: Artikel	Seite
<i>Artikelnummern aufsteigend</i>	
<b>1090686</b> Uponor S-Press Übergangsnippel Edelstahl	16-R1/2"MT 14
<b>1090687</b> Uponor S-Press Übergangsnippel Edelstahl	20-R3/4"MT 14
<b>1090688</b> Uponor S-Press Übergangsnippel Edelstahl	25-R3/4"MT 14
<b>1090689</b> Uponor S-Press Übergangsmuffe Edelstahl	25-Rp3/4"FT 14
<b>1090690</b> Uponor S-Press Übergangsmuffe Edelstahl	32-Rp1"FT 14
<b>1090691</b> Uponor Smart Aqua U-Wandscheibe Edelstahl	S-Press 16-Rp1/2"FT-16 14
<b>1090692</b> Uponor Smart Aqua U-Wandscheibe Edelstahl	S-Press 20-Rp1/2"FT-20 14
<b>1090693</b> Uponor Smart Aqua Wandscheibe Edelstahl	S-Press 16-Rp1/2"FT 14
<b>1090694</b> Uponor Smart Aqua Wandscheibe Edelstahl	S-Press 20-Rp1/2"FT 14
<b>1090916</b> Uponor Tacker Rolle	EPS DEO 26mm 10x1m
<b>1090923</b> Uponor Tacker Rolle	G EPS DES WLS032 25-2mm 10x1m
<b>1096432</b> Uponor Ecoflex Hauseinführungsbogen	Twin 2x40x3,7/160
<b>1005104</b> Uponor Vario Handrad m.Einstellungsanz.Ring	COMP
<b>1013004</b> Uponor Vario Durchflussmesser mit Schauglas rot	A
<b>1046632</b> Uponor Vario Rücklaufventileinsatz für KPV	COMP
<b>1046738</b> Uponor Q&E Ersatz Akku Li-ion	ProPEX 14,4V 2,4Ah
<b>1046739</b> Uponor Q&E Akku-Schnelladegerät	ProPEX 230V AC 50HZ/16,5V 4A 100W
<b>1085956</b> Uponor Vario M Durchflussanzeige	0-5l/min 41
<b>1090942</b> Uponor Comfort E Kabel	R-Set 230V
<b>1090943</b> Uponor Comfort E Schutzrohr	

Art.-Nr.: Artikel	Seite
-------------------	-------



# Allgemeine Liefer- und Zahlungsbedingungen der Uponor GmbH

## 1. Allgemeines

- 1.1 Unsere Lieferungen und Leistungen erfolgen ausschließlich aufgrund der nachstehenden Bedingungen. Abweichungen haben nur dann Gültigkeit, wenn sie schriftlich von uns bestätigt werden.
- 1.2 Mit der Erteilung des Auftrages, spätestens mit der Entgegennahme der Ware erkennt der Käufer unsere Allgemeinen Liefer- und Zahlungsbedingungen an. Abweichende Bedingungen des Käufers, die wir nicht ausdrücklich schriftlich anerkennen, sind für uns unverbindlich, auch wenn wir ihnen nicht ausdrücklich widersprechen.
- 1.3 Diese Bedingungen gelten auch für zukünftige Lieferungen aufgrund schriftlicher oder fernmündlicher Bestellungen des Käufers.
- 1.4 Alle Bestellungen, Aufträge und Vereinbarungen werden für uns erst mit Zugang unserer schriftlichen Auftragsbestätigung beim Käufer oder, falls eine Auftragsbestätigung nicht erteilt wird, mit Lieferung der Ware verbindlich. Mündliche oder telefonische Zusagen oder sonstige Abreden einschließlich etwaiger Ergänzungen, Abänderungen und Nebenabreden zu bereits angenommenen Bestellungen sowie durch unsere Vertreter getätigte Verkäufe sind für uns erst verbindlich, sobald und soweit sie von uns nachträglich schriftlich bestätigt sind.
- 1.5 Für Maschinen und Werkzeugverkäufe gelten ergänzend unsere diesbezüglichen Zusatzbedingungen.

## 2. Preise und Lieferung

- 2.1 Unsere Listen- und Angebotspreise sind freibleibend und unverbindlich, sofern nicht eine bestimmte Geltungsdauer schriftlich vereinbart ist. Alle Preise verstehen sich in EURO ab Werk ohne Verpackung, Verladung, Fracht und Montage zuzüglich der jeweils geltenden Mehrwertsteuer. Bei einer Direkt-/ Streckenlieferung mit einem Warenbestellwert unter 500 € netto wird ein Mindermengenzuschlag von 20 € zzgl. gesetzlicher Mehrwertsteuer pro Lieferung berechnet. Bei Lieferungen an das Lager des Käufers erfolgt die Lieferung grundsätzlich in vollständigen Verpackungseinheiten gemäß der aktuellen Preisliste. Müssen wir für die Bearbeitung einer Bestellung eine oder mehrere Verpackungseinheiten anbrechen, weil der Käufer lediglich eine anteilige Verpackungseinheit eines oder mehrerer Artikel bestellt hat, werden dem Käufer für diesen Mehraufwand pro Bestellung pauschal 20 € zzgl. gesetzlicher Mehrwertsteuer zusätzlich berechnet.
- 2.2 Unabhängig davon, ob eine Versendung ab Werk erfolgt und wer die Frachtkosten trägt, hat der Käufer alle Gefahren des Verlustes oder der Beschädigung der Ware von dem Zeitpunkt an zu tragen, zu dem ihm die Ware – ohne Verladung auf das abholende Beförderungsmittel – ab Werk zur Verfügung gestellt wurde.
- 2.3 Etwa notwendige Verpackung wird zum Selbstkostenpreis berechnet und nicht zurückgenommen.
- 2.4 Alle Liefertermine und Fristen gelten nur als annähernd, sofern sie nicht schriftlich ausdrücklich als verbindlich zugesagt werden. Wünscht der Käufer Lieferung zu einem späteren als dem ursprünglich vereinbarten Termin, können wir die Vertragsleistung zum vereinbarten Liefertermin in Rechnung stellen und die Ware auf Kosten des Käufers einlagern. Erfolgt eine Lagerung in unserem Werk, sind wir berechtigt, ein Lagergeld in Höhe von 2,5‰ des Auftragsnettowerts für jeden angefangenen Monat der Lagerung zu verlangen.
- 2.5 Teillieferungen sind zulässig.
- 2.6 Bestellt der Käufer Ware auf Abruf, so gilt der Abruf spätestens sechs Monate nach der Bestellung als erfolgt, es sei denn, es ist schriftlich eine andere Vereinbarung getroffen worden.
- 2.7 Betriebsstörungen, Kriegszustand, Arbeitskämpfe oder sonstige Ereignisse höherer Gewalt bei uns oder unseren Lieferanten berechtigen uns, die Lieferung um die betreffende Zeitdauer hinauszuschieben. Wir werden dem Käufer solche Hindernisse unverzüglich mitteilen. Erhöhen sich infolge derartiger unvorhergesehener Umstände unsere Kosten, so sind wir zu entsprechenden Preiskorrekturen berechtigt, insbesondere zur Berechnung der Tagespreise am Versandtag.

- 2.8 Begründete Zweifel an der Kreditwürdigkeit des Käufers berechtigen uns, vom Käufer für unsere Lieferungen Sicherheit oder Vorkasse zu verlangen oder vom Vertrag zurückzutreten. Schadensersatzansprüche des Käufers sind in diesen Fällen ausgeschlossen.

## 3. Zahlungsbedingungen

- 3.1 Zahlungstermine und Zahlungsfristen werden gesondert vereinbart. Bei Zielüberschreitungen werden bankübliche Zinsen, mindestens aber die gesetzlichen Verzugszinsen berechnet.
- 3.2 Die Annahme von Wechseln und Schecks erfolgt stets zahlungshalber; erst die Einlösung gilt als Zahlung. Die Annahme von Wechseln bedarf der gesonderten Vereinbarung. Diskontspesen und Kosten gehen zu Lasten des Kunden.
- 3.3 Unsere Angestellten, Vertreter oder Vertriebspartner sind nicht zur Entgegennahme von Zahlungen für uns berechtigt. Ausnahmen bedürfen unserer ausdrücklichen schriftlichen Einwilligung.
- 3.4 Mit von uns nicht anerkannten oder nicht rechtskräftig festgestellten Gegenansprüchen kann der Käufer weder aufrechnen noch wegen dieser Ansprüche ein Zurückbehaltungsrecht geltend machen.
- 3.5 Hält der Käufer die Zahlungsbedingungen nicht ein oder treten berechtigte Zweifel an der Kreditwürdigkeit des Käufers auf, so werden alle unsere Forderungen aus der gesamten Lieferbeziehung zum Käufer sofort fällig.

## 4. Eigentumsvorbehalt

- 4.1 Die gelieferten Waren bleiben bis zur vollständigen Bezahlung sämtlicher Lieferungen nebst allen Nebenforderungen aus der gesamten Geschäftsbeziehung einschließlich der Einlösung etwa von uns in Zahlung genommener Schecks oder Wechsel unser Eigentum. Unsere Forderungen gehen nicht durch Aufnahme in einen kontokorrentmäßigen Saldo und dessen Anerkennung unter.
- 4.2 Der Käufer hat die Vorbehaltsware ausreichend zu kennzeichnen und sie angemessen gegen Feuer und Einbruch-Diebstahl zu versichern.
- 4.3 Eine etwaige Be- oder Verarbeitung der Vorbehaltsware nimmt der Käufer für uns vor, ohne dass uns daraus Verpflichtungen entstehen. Bei Verarbeitung oder Verbindung der Vorbehaltsware mit anderen, nicht uns gehörenden Waren steht uns das dabei entstehende Miteigentum an der neuen Sache zu, und zwar im Verhältnis des Wertes der Vorbehaltsware zu der übrigen verarbeiteten Ware im Zeitpunkt der Verarbeitung oder Verbindung. Erwirbt der Käufer das Alleineigentum an der neuen Sache, so räumt er uns im Verhältnis des Wertes der verarbeiteten bzw. verbundenen Vorbehaltsware zum Gesamtwert der neuen Sache Miteigentum an der neuen Sache ein und verwahrt sie unentgeltlich für uns.
- 4.4 Der Käufer ist zur Weiterveräußerung der Vorbehaltsware im normalen Geschäftsverkehr berechtigt. Eine Verpfändung, Sicherungsübereignung oder ein Verleih ist ihm jedoch nicht gestattet. Veräußert der Käufer Vorbehaltsware weiter, so tritt er uns bereits jetzt seine künftigen Forderungen aus der Weiterveräußerung gegen seine Kunden mit allen Nebenrechten – einschließlich etwaiger Saldoforderungen – sicherungshalber ab, ohne dass es noch späterer besonderer Erklärungen bedarf. Wir nehmen die Abtretung an.
- 4.5 Wird die Vorbehaltsware von dem Käufer mit Grundstücken verbunden, so tritt der Käufer schon jetzt die daraus entstehende Forderung auf Vergütung in Höhe des Wertes der Vorbehaltsware mit allen Nebenrechten einschließlich des Rechts auf Einräumung einer Sicherungshypothek ab. Die Abtretung hat Vorrang vor sonstigen dem Käufer gegenüber seinem Kunden etwa zustehenden Ansprüchen. Wir nehmen die Abtretung an.
- 4.6 Wird die Vorbehaltsware zusammen mit anderen Waren – gleich ob ohne oder nach Verarbeitung oder Verbindung – weiterveräußert, so tritt der Käufer seine Forderungen aus der Weiterveräußerung der Vorbehaltsware ebenfalls an uns ab, jedoch nur in Höhe des Wertes der Vorbehaltsware, die zusammen mit den anderen Waren Gegenstand des Verkaufs ist. Entsprechendes gilt für etwaige Saldoforderungen. Wir nehmen die Abtretung an.



- 4.7 Bis auf Widerruf ist der Käufer zur Einziehung der abgetretenen Forderungen befugt. Wir sind zum Widerruf dieser Einziehungsbefugnis berechtigt, wenn der Käufer seinen Verpflichtungen uns gegenüber nicht nachkommt oder sonstige wichtige Gründe vorliegen, insbesondere Zahlungseinstellung, Eröffnung eines Insolvenzverfahrens, Wechselprotest oder vergleichbare Anhaltspunkte, die eine Zahlungsunfähigkeit des Käufers nahelegen. Im Falle des Widerrufs hat der Käufer uns die zur Einziehung unserer Forderungen erforderlichen Angaben über die abgetretenen Forderungen zu machen und den Schuldnern die Abtretung mitzuteilen.
- 4.8 Übersteigt der realisierbare Wert der uns nach Maßgabe der vorstehenden Ziffern zur Verfügung gestellten Sicherheiten die zu sichernden Forderungen aus der gesamten Geschäftsbeziehung um mehr als 20 %, sind wir auf Verlangen des Käufers insoweit zur Freigabe von Sicherheiten nach eigener Wahl verpflichtet.
- 4.9 Über das etwaige Abhandenkommen sowie die Beschädigung oder Zerstörung von Vorbehaltsware hat uns der Käufer unverzüglich zu unterrichten. Dasselbe gilt für Zwangsvollstreckungsmaßnahmen Dritter in die Vorbehaltsware oder in die abgetretenen Forderungen. Der Käufer hat uns alle Informationen zur Verfügung zu stellen, die wir benötigen, um unsere Rechte Dritten gegenüber geltend zu machen.
- 4.10 Die Geltendmachung von Eigentumsvorbehaltsrechten durch uns gilt nicht als Rücktritt vom Vertrag.
5. Haftung für Mängel
- 5.1 Die in dieser Produktinformation oder sonstigen Prospekten, Werbematerialien, Beschreibungen usw. enthaltenen Angaben beruhen auf dem aktuellen Stand unserer Erkenntnisse und Erfahrungen. Anwendung, Verwendung und Verarbeitung erfolgen außerhalb unserer Kontrollmöglichkeiten. Alle Angaben sind deswegen nur als ungefähre Angaben und nicht als Beschaffenheitsangaben anzusehen. Sie begründen keine Beschaffenheits- oder Haltbarkeitsgarantie. Die Eignung unserer Produkte für den vorgesehenen Anwendungszweck ist durch den Käufer zu prüfen.
- 5.2 Der Käufer hat gelieferte Ware unverzüglich zu untersuchen. Offenkundige Mängel sind uns spätestens innerhalb von acht Tagen nach Empfang der Ware schriftlich mitzuteilen, andere Mängel unverzüglich nach ihrem Auftreten. Unsere Haftung für Mängel, die nicht rechtzeitig angezeigt worden sind, ist ausgeschlossen.
- 5.3 Nimmt der Käufer mangelhafte Ware an, obwohl er den Mangel kennt oder infolge grober Fahrlässigkeit nicht kennt, so stehen ihm Ansprüche und Rechte wegen dieser Mängel nur zu, wenn er sich diese bei der Annahme vorbehalten hat. Bei begründeten Beanstandungen bessern wir nach unserer Wahl die mangelhaften Liefergegenstände nach oder liefern Ersatz. Aus- und Einbaukosten sowie sonstige mit der Nacherfüllung verbundenen Kosten, insbesondere Transport-, Wege-, Arbeits- und Materialkosten, übernehmen wir nicht, wenn und soweit solche Kosten dadurch entstanden sind oder sich erhöht haben, daß der Besteller den Liefergegenstand eingebaut oder sonst verarbeitet hat, obwohl Mängel erkennbar waren.
- 5.4 Ansprüche wegen Mängel der Sache bestehen nicht bei nur unerheblicher Abweichung des Liefergegenstandes von der vereinbarten Beschaffenheit, einer unerheblichen Beeinträchtigung der Brauchbarkeit, im Falle natürlicher Abnutzung, Beschädigung durch Gewalt, durch unsachgemäße Behandlung oder Verwendung, übermäßige Beanspruchung, elementare Einflüsse oder im Falle eigenmächtiger, selbst vorgenommener oder bei Dritten veranlaßter Eingriffe des Käufers an der Ware.
- 5.5 Alle Ansprüche wegen Mängel der Sache verjähren in zwölf Monaten ab Lieferung. Abweichend davon gilt für Mängel an Liefergegenständen, die entsprechend ihrer üblichen Verwendungsweise für ein Bauwerk verwendet worden sind und dessen Mangelhaftigkeit verursacht haben, die gesetzliche Verjährungsfrist.
- 5.6 Für Schadensersatz wegen Mängel der Sache haften wir ausschließlich im Rahmen der nachstehenden Ziffer 6.
- 5.7 Ansprüche des Käufers aus weitergehenden Erklärungen, die wir ausdrücklich und schriftlich im Zusammenhang mit Lieferungen abgegeben haben, bleiben von den vorstehenden Bestimmungen unberührt.
6. Haftung für Schadensersatzansprüche
- 6.1 Wir haften nicht für Verzögerungsschäden und für Schäden, die auf einer leicht fahrlässigen Pflichtverletzung oder Handlung beruhen. Dies gilt nicht, wenn die Pflichtverletzung oder Handlung zu einer Verletzung des Lebens, des Körpers oder der Gesundheit führt oder in der Verletzung wesentlicher vertraglicher Pflichten besteht.
- 6.2 Wir haften nicht für leicht fahrlässiges Handeln unserer Organe und/oder leitender Angestellter und nicht für leicht und/oder grob fahrlässiges Handeln nicht leitender Angestellter, sofern keine den Vertragszweck gefährdenden wesentlichen Pflichten verletzt werden und die Pflichtverletzung nicht zu einer Verletzung des Lebens, des Körpers oder der Gesundheit führt.
- 6.3 Unsere Haftung ist in allen Fällen begrenzt auf die bei Vertragsabschluss vorhersehbaren, typischen Schäden, die aus der Pflichtverletzung oder Handlung resultieren.
- 6.4 Mit der vorstehenden Regelung ist eine Änderung der Beweislast zum Nachteil des Käufers nicht verbunden.
- 6.5 Ansprüche des Käufers aus sonstigen Erklärungen, die wir ausdrücklich und schriftlich im Zusammenhang mit Lieferungen abgegeben haben, sowie zwingende gesetzliche Ansprüche des Käufers, insbesondere nach Maßgabe des Produkthaftungsgesetzes, bleiben unberührt.
7. Gerichtsstand
- Gerichtsstand ist für beide Teile Haßfurt, sofern der Käufer Kaufmann, juristische Person des öffentlichen Rechts oder öffentlich-rechtliches Sondervermögen ist. Das gilt auch für Scheck- und Wechselprozesse. Wir sind darüber hinaus berechtigt, den Käufer an seinem allgemeinen Gerichtsstand zu verklagen.
8. Schlussbestimmungen
- 8.1 Es gilt ausschließlich deutsches Recht mit Ausnahme der Regeln über das internationale Privatrecht und des UN-Abkommens über den internationalen Warenkauf (CISG).
- 8.2 Wir sind berechtigt, die uns im Rahmen der Geschäftsbeziehung oder im Zusammenhang mit ihr zugänglich gemachten Daten über den Käufer im Sinne des Bundesdatenschutzgesetzes zu verarbeiten.
- 8.3 Falls einzelne Bestimmungen dieser Allgemeinen Liefer- und Zahlungsbedingungen unwirksam sind oder werden sollten, wird die Wirksamkeit der übrigen Bestimmungen dadurch nicht berührt.
- 8.4 Durch diese Allgemeinen Liefer- und Zahlungsbedingungen werden alle früher geltenden Geschäftsbedingungen aufgehoben und ersetzt.



# Moving ➤ Forward

Auszug aus dem umfangreichen Programm als Kurzpreisliste Deutschland 2022.  
Das vollständige Uponor Portfolio ist online als Gesamtpreisliste verfügbar.

## Technische Hotline 0800 7780030

Kostenfrei aus dem deutschen Festnetz, Mobil- und Auslandsverbindungen abweichend.

# uponor

**Uponor GmbH**  
Industriestraße 56  
97437 Haßfurt

**T** +49 (0)9521 690-0  
**F** +49 (0)9521 690-710  
**E** [info.de@uponor.com](mailto:info.de@uponor.com)