

**Trinkwasserinstallation
Flächenheizung/-kühlung
Nahwärmeversorgung**

uponor

Kurzpreisliste Deutschland 2021

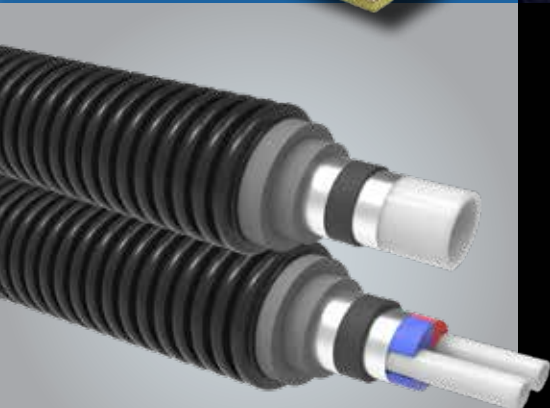
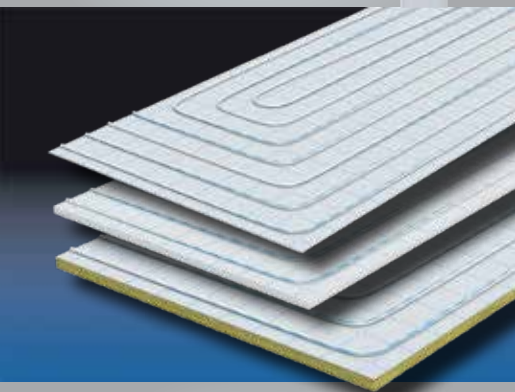
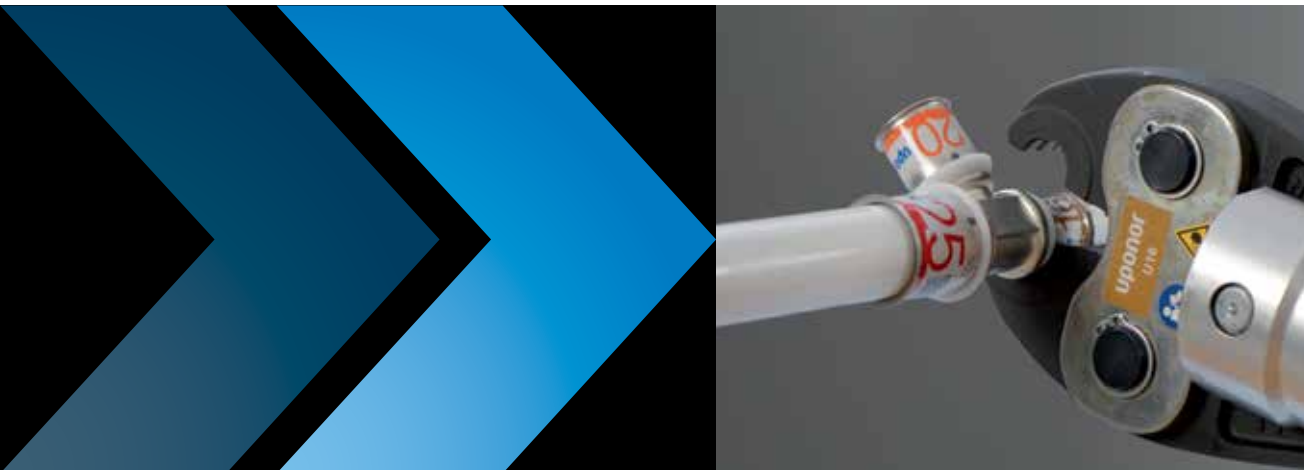

Moving > Forward

Auszug aus dem umfangreichen Programm als Kurzpreisliste Deutschland 2021.
Das vollständige Uponor Portfolio ist online als Gesamtpreisliste verfügbar.



Download der vollständigen Preisliste
Deutschland 2021



Online Produktkatalog



Uponor Downloadcenter

- **Auszug aus dem umfangreichen Programm als Kurzpreisliste Deutschland 2021.**
Das vollständige Uponor Portfolio ist online als Gesamtpreisliste verfügbar.
- Alle Preise sind unverbindliche Preisempfehlungen in Euro zzgl. der gültigen Mehrwertsteuer.
- Die angegebenen Werkzeugpreise sind Nettopreise.
- Es gelten unsere Verkaufs- und Lieferbedingungen.
- Nachstehende Preise verstehen sich ab Werk ausschließlich Transportverpackung.
- Technische und inhaltliche Änderungen behalten wir uns vor.
- Mehr Infos unter www.uponor.de

Alle rechtlichen und technischen Informationen wurden nach bestem Wissen sorgfältig zusammengestellt. Fehler können dennoch nicht vollständig ausgeschlossen und hierfür keine Haftung übernommen werden. Das Werk ist einschließlich aller seiner Teile urheberrechtlich geschützt. Jede Verwertung außerhalb der durch das Urhebergesetz zugelassenen Ausnahmen ist ohne Zustimmung der Uponor GmbH nicht gestattet. Insbesondere Vervielfältigungen, der Nachdruck, Bearbeitungen, Speicherung und Verarbeitung in elektronischen Systemen, Übersetzungen und Mikroverfilmungen behalten wir uns vor.

Technische Änderungen vorbehalten.

Installationssysteme

Trinkwasser- und Heizungsinstallation	4
Uponor Verbundrohrsysteme	

Installation

Flächenheizung/-kühlung

Flächenheiz-/kühlsysteme für Boden, Wand und Decke	20
Verteiler und -zubehör	42
Raumtemperaturregelung	48
Vorlauftemperaturregelung / Pumpengruppen	57

Flächenheizung und -kühlung

Nahwärmeversorgung

Flexible vorgedämmte Rohrleitungen und Verbindungstechniken für erdverlegte Nahwärmenetze	60
--	----

Nahwärmeversorgung

Werkzeuge

Werkzeuge für die Verarbeitung von Installationsrohren und Rohren in der Flächenheizung/-kühlung	73
---	----

Werkzeuge

Installationsrohre und Verbindungstechnik











Unterschiedliche Montagesituationen und Einsatzbereiche verlangen nach perfekt darauf abgestimmten Fittingkonzepten. Deshalb entwickelt und produziert Uponor nicht nur Rohre, sondern gleichzeitig auch die passenden auf den jeweiligen Einsatz zugeschnittenen Fittingsysteme. Das Uponor Fittingprogramm mit Kupplungen, Winkeln, T-Stücken und einer Vielzahl von praxisgerechten Systemkomponenten schafft die Voraussetzung für eine schnelle, sichere und praxisgerechte Montage und übertrifft dabei die Anforderungen, die an eine hygienische Trinkwasser-Installation und an die zeitgemäße Heizungsverrohrung gestellt werden.

Installation

Trinkwasser- und Heizungsinstallation

Uponor Fittingsystem

Dimension/ Farbcode	Verbund- rohrtyp
------------------------	---------------------

 14	MLC
 16	Uni Pipe PLUS
 20	Uni Pipe PLUS
 25	Uni Pipe PLUS
 32	Uni Pipe PLUS
 40	MLC
 50	MLC
 63	MLC
 75	MLC
 90	MLC
 110	MLC

Eigenschaften

Dimensionsabhängige Farbcodierung

Sichtfenster zur Kontrolle der Einstecktiefe

Verpresstkennzeichnung
durch Ablösen der Folie von der Presshülse

Verpresstkennzeichnung
durch Ablösung des Anschlagringes

Verpresstkennzeichnung
durch Pressabdruck auf Presshülse

Montage ohne Entgraten

Montage ohne Kalibrieren









Verbinder unverpresst undicht

Integrierte Pressfunktion

Modulares Fittingsystem

¹⁾ bis Dimension 32

²⁾ ab Dimension 40

Press-Fitting, Metall				Press-Fitting, Verbund		RTM Fitting	Uni-C 1/2"	Uni-X 3/4"
S-Press PLUS	S-Press		RS	S-Press PLUS, PPSU	S-Press PPSU			
								
	•						•	•
•	•		•	•		•	•	•
•			•	•		•	•	•
•			•	•		•		•
•			•	•				
		•	•		•			
		•	•		•			
		•	•		•			
		•	•		•			
			•					
			•					
•	•	•	•	•	•	•		
•	•	•	•	•	•	•		
•				•				
	•		• ¹⁾					
•		•	• ²⁾	•	•			
•	•		• ¹⁾	•		•	•	•
•	•	•	•	•	•		•	•
•	•	•	•	•	•			
						•		
			•					

Uponor Uni Pipe PLUS Verbundrohre

Installation

Trinkwasser- und Heizungsinstallation

Art-Nr.	Dimension	LE	VE	ME	Preis/ME
---------	-----------	----	----	----	----------

Uponor Uni Pipe PLUS weiß S

 1060783	16x2,0	75	3	m	5,78
1059572	16x2,0	125	5	m	5,50
1060784	20x2,25	51	3	m	7,46
1059573	20x2,25	85	5	m	7,11
1060785	25x2,5	33	3	m	10,90
1059574	25x2,5	55	5	m	10,50
1060786	32x3,0	21	3	m	14,51
1059575	32x3,0	35	5	m	14,92

Uponor MLC Rohr weiß S

 1013448	40x4,0	12	3	m	29,03
1013446	40x4,0	20	5	m	28,53
1021980	50x4,5	12	3	m	41,17
1013449	50x4,5	20	5	m	40,73
1021981	63x6,0	9	3	m	52,22
1013451	63x6,0	15	5	m	50,97
1013453	75x7,5	255	5	m	82,49
1013455	90x8,5	255	5	m	89,88
1013457	110x10,0	165	5	m	107,01

Uponor Uni Pipe PLUS weiß

 1059576	16x2,0	2000	100	m	2,80
1092653	16x2,0	2400	120	m	2,80
1059577	16x2,0	2600	200	m	2,80
1059578	16x2,0	3500	500	m	2,80
1059579	20x2,25	1300	100	m	4,99
1093124	20x2,25	2000	500	m	4,99
1059581	25x2,5	700	50	m	10,35
1059583	32x3,0	400	50	m	14,57

Uponor MLC Rohr weiß

 1013366	14x2,0	2600	200	m	2,91
--	--------	------	-----	---	-------------

Uponor Uni Pipe PLUS weiß vorgedämmt S4 WLS 040

 1091709	16x2,0	rot	800	100	m	4,99
1063553	16x2,0	blau	800	100	m	4,99
1091710	20x2,25	rot	800	100	m	6,65
1063555	20x2,25	blau	800	100	m	6,65
1091711	25x2,5	rot	400	50	m	16,37
1063946	25x2,5	blau	400	50	m	16,37
1091712	32x3,0	rot	350	50	m	22,52
1091716	32x3,0	blau	350	50	m	22,52

Art-Nr.	Dimension	LE	VE	ME	Preis/ME
---------	-----------	----	----	----	----------

Uponor Uni Pipe PLUS weiß vorgedämmt S6 WLS 035

 1063556	16x2,0	blau	600	75	m	5,23
1063557	20x2,25	blau	600	75	m	6,46
1063558	25x2,5	blau	400	50	m	15,30

Uponor Uni Pipe PLUS weiß vorgedämmt S10 WLS 035

 1062181	16x2,0	blau	450	75	m	5,75
1062182	20x2,25	blau	525	75	m	7,45
1062183	25x2,5	blau	350	50	m	16,49

Uponor Uni Pipe PLUS weiß vorgedämmt DHS9

 1063559	16x2,0	blau	525	75	m	6,40
1063560	20x2,25	blau	525	75	m	8,05

Uponor Uni Pipe PLUS weiß vorgedämmt DHS26

 1063561	16x2,0	blau	200	25	m	11,25
1063562	20x2,25	blau	200	25	m	12,94

Uponor Uni Pipe PLUS weiß im Schutzrohr

 1063061	16x2,0 - 25/20	rot	1350	75	m	5,11
1063059	16x2,0 - 25/20	blau	1350	75	m	5,11
1063062	20x2,25 - 28/23	rot	900	75	m	7,90
1063060	20x2,25 - 28/23	blau	900	75	m	7,90

Uponor Teck Schutzrohr

 1012860	25/20	schwarz	2500	50	m	1,16
1012864	28/23	schwarz	2000	50	m	1,61
1012869	35/29	schwarz	1400	50	m	2,21
1012872	43/36	schwarz	600	25	m	3,36

Uponor Teck Schutzrohr

 1012859	25/20	blau	2500	50	m	1,16
1012863	28/23	blau	2000	50	m	1,61
1012867	35/29	blau	1400	50	m	2,21

Uponor Teck Schutzrohr

 1012858	25/20	rot	2500	50	m	1,16
1012862	28/23	rot	2000	50	m	1,61
1012866	35/29	rot	1400	50	m	2,21

Uponor Teck Dübelhaken einfach

 1013137	32 60mm	1000	50	St.	0,72
1013138	32 80mm	1000	50	St.	0,72

Uponor Teck Dübelhaken doppelt

 1013139	32 60mm	1000	50	St.	0,96
1013140	32 80mm	1000	50	St.	0,96

Uponor S-Press PLUS PPSU

Art-Nr.	Dimension	LE	VE	ME	Preis/ME
---------	-----------	----	----	----	----------

Uponor S-Press PLUS Winkel PPSU

 1039929	16-16	80	20	St.	6,49
1039930	20-20	80	10	St.	8,47
1039931	25-25	80	10	St.	15,31
1039932	32-32	20	5	St.	21,07

Uponor S-Press Verbund Winkel PPSU

 1046386	40-40	960	5	St.	40,28
1046387	50-50	576	3	St.	50,29
1032877	63-63	210	1	St.	98,14
1032878	75-75	210	1	St.	157,99

Uponor S-Press Verbund Winkel 45° PPSU

 1046388	40-40	960	5	St.	40,79
1046389	50-50	576	3	St.	52,84
1032879	63-63	192	1	St.	102,30
1032880	75-75	192	1	St.	147,29

Uponor S-Press PLUS Kupplung PPSU

 1039933	16-16	80	20	St.	5,25
1039934	20-20	80	10	St.	7,18
1039935	25-25	80	10	St.	10,63
1039936	32-32	80	10	St.	15,61

Uponor S-Press Verbund Kupplung PPSU

 1046401	40-40	960	5	St.	28,18
1046402	50-50	576	3	St.	36,72
1032881	63-63	384	1	St.	73,65
1032882	75-75	384	1	St.	121,31

Uponor S-Press PLUS Kupplung reduziert PPSU

 1039937	20-16	80	20	St.	7,31
1039938	25-16	80	10	St.	9,91
1039939	25-20	80	10	St.	9,91
1039940	32-25	80	10	St.	15,97

Uponor S-Press Kupplung reduziert PPSU

 1039941	40-25	960	5	St.	28,18
1039942	40-32	960	5	St.	28,18
1039943	50-32	1152	3	St.	36,72
1046406	50-40	576	3	St.	36,72
1032883	63-40	384	1	St.	69,62
1032884	63-50	384	1	St.	71,10
1032885	75-50	384	1	St.	102,30
1032886	75-63	384	1	St.	113,15

Art-Nr.	Dimension	LE	VE	ME	Preis/ME
---------	-----------	----	----	----	----------

Uponor S-Press PLUS T-Stück PPSU

 1039944	16-16-16	80	10	St.	10,16
1039945	20-20-20	80	10	St.	14,50
1039946	25-25-25	20	5	St.	17,40
1039947	32-32-32	20	5	St.	28,57

Uponor S-Press Verbund T-Stück PPSU

 1046390	40-40-40	720	5	St.	55,50
1046391	50-50-50	288	3	St.	69,50
1032887	63-63-63	150	1	St.	130,82
1032888	75-75-75	150	1	St.	206,18

Uponor S-Press PLUS T-Stück reduziert PPSU

 1039948	16-20-16	80	10	St.	14,50
1039949	20-16-16	80	10	St.	14,50
1039950	20-16-20	80	10	St.	14,50
1039951	20-20-16	80	10	St.	14,50
1039952	20-25-20	80	10	St.	18,98
1039953	25-16-16	80	10	St.	18,98
1039954	25-16-20	80	10	St.	18,98
1039955	25-16-25	80	10	St.	18,98
1039956	25-20-20	80	10	St.	18,98
1039957	25-20-25	80	10	St.	18,98
1039958	32-16-32	20	5	St.	30,68
1039959	32-20-32	20	5	St.	30,68
1039960	32-25-25	20	5	St.	30,68
1039961	32-25-32	20	5	St.	30,68

Uponor S-Press T-Stück reduziert PPSU

 1039962	40-20-40	960	5	St.	55,50
1039963	40-25-32	960	5	St.	55,50
1039964	40-25-40	720	5	St.	55,50
1039965	40-32-32	960	5	St.	55,50
1039966	40-32-40	720	5	St.	55,50
1039967	50-25-40	432	3	St.	64,46
1039968	50-25-50	432	3	St.	64,46
1039969	50-32-50	432	3	St.	64,46

Uponor S-Press Verbund T-Stück reduziert PPSU

 1046400	50-40-50	288	3	St.	64,46
1032889	63-25-63	150	1	St.	118,90
1032890	63-32-63	150	1	St.	122,78
1032891	63-40-63	150	1	St.	122,78
1032892	75-32-75	150	1	St.	155,29
1032893	75-40-75	150	1	St.	179,43
1032894	75-50-75	150	1	St.	179,43

Uponor S-Press PLUS

Installation
Trinkwasser- und Heizungsinstallation

Art-Nr.	Dimension	LE	VE	ME	Preis/ME
---------	-----------	----	----	----	----------

Uponor S-Press Übergangsnippel

 1014513	14-R $\frac{1}{2}$ "MT	80	20	St.	8,97
--	------------------------	----	----	-----	-------------

Uponor S-Press Übergangsmuffe

 1014515	14-Rp $\frac{1}{2}$ "FT	80	20	St.	12,55
--	-------------------------	----	----	-----	--------------

Uponor S-Press Kupplung

 1015154	14-14	80	10	St.	10,72
--	-------	----	----	-----	--------------

Uponor S-Press Kupplung reduziert

 1015162	16-14	80	20	St.	10,03
--	-------	----	----	-----	--------------

Uponor S-Press T-Stück

 1014886	14-14-14	80	10	St.	16,55
--	----------	----	----	-----	--------------

Uponor S-Press T-Stück reduziert

 1014888	14-16-14	80	10	St.	22,06
 1014912	16-14-14	80	10	St.	22,06
 1014915	16-14-16	80	10	St.	22,06

Uponor S-Press Übergang auf Kupfer

 1014511	14-15CU	80	10	St.	24,51
--	---------	----	----	-----	--------------

Uponor S-Press Übergangskupplung auf Rapex

 1015156	14-14	80	20	St.	13,65
--	-------	----	----	-----	--------------

Uponor Smart Aqua Wandscheibe S-Press









 1015437	14-Rp $\frac{1}{2}$ "FT	40	10	St.	19,99
--	-------------------------	----	----	-----	--------------

Uponor Smart Radi Anschlusswinkel S-Press







 1015615	14-15CU l=350mm	640	20	St.	21,12
--	-----------------	-----	----	-----	--------------

Art-Nr.	Dimension	LE	VE	ME	Preis/ME
---------	-----------	----	----	----	----------









Uponor S-Press PLUS Übergangsnippel

 1070502	16-R $\frac{1}{2}$ "MT	80	20	St.	8,22
 1070503	16-R $\frac{3}{4}$ "MT	120	15	St.	10,91
 1070504	20-R $\frac{1}{2}$ "MT	80	20	St.	12,42
 1070505	20-R $\frac{3}{4}$ "MT	80	10	St.	12,42
 1070506	20-R1"MT	80	10	St.	17,49
 1070507	25-R $\frac{3}{4}$ "MT	80	10	St.	16,88
 1070508	25-R1"MT	40	5	St.	19,95
 1070509	32-R1"MT	40	5	St.	21,96
 1070510	32-R1 $\frac{1}{4}$ "MT	20	5	St.	28,46



Uponor S-Press Übergangsnippel

 1046901	40-R1 $\frac{1}{4}$ "MT	960	5	St.	35,56
 1046902	40-R1 $\frac{1}{2}$ "MT	960	5	St.	39,33
 1046905	50-R1 $\frac{1}{2}$ "MT	1152	3	St.	59,00
 1046906	50-R2"MT	576	3	St.	75,82
 1032895	63-R2"MT	336	1	St.	107,65
 1032896	75-R2 $\frac{1}{2}$ "MT	336	1	St.	141,91





Uponor S-Press PLUS Übergangsmuffe

 1070515	16-Rp $\frac{1}{2}$ "FT	80	20	St.	9,73
 1070516	20-Rp $\frac{1}{2}$ "FT	120	15	St.	14,59
 1070517	20-Rp $\frac{3}{4}$ "FT	80	10	St.	14,59
 1070518	20-Rp1"FT	80	20	St.	20,24
 1070519	25-Rp $\frac{3}{4}$ "FT	40	5	St.	19,64
 1070520	25-Rp1"FT	40	5	St.	20,67
 1070521	32-Rp1"FT	40	5	St.	24,03
 1070522	32-Rp1 $\frac{1}{4}$ "FT	20	5	St.	29,66

Uponor S-Press Übergangsmuffe

 1046903	40-Rp1 $\frac{1}{4}$ "FT	960	5	St.	37,00
 1046904	40-Rp1 $\frac{1}{2}$ "FT	960	5	St.	37,39
 1046907	50-Rp1 $\frac{1}{2}$ "FT	1152	3	St.	90,16





Uponor S-Press PLUS Winkel

 1070523	16-16	80	20	St.	9,76
 1070524	20-20	80	10	St.	13,14
 1070525	25-25	40	5	St.	19,15
 1070526	32-32	20	5	St.	29,02

Uponor S-Press Winkel

 1046908	40-40	600	5	St.	43,65
 1046911	50-50	240	3	St.	57,91

Uponor S-Press PLUS Bogen

 1070527	16-16	80	10	St.	13,97
 1070528	20-20	80	10	St.	16,50
 1070529	25-25	40	5	St.	24,08
 1070530	32-32	20	5	St.	30,46

Uponor S-Press PLUS

Art-Nr.	Dimension	LE	VE	ME	Preis/ME
---------	-----------	----	----	----	----------

Uponor S-Press PLUS Winkelnippel

 1070532	16-R $\frac{1}{2}$ "MT	80	20	St.	11,74
1070533	20-R $\frac{1}{2}$ "MT	80	10	St.	20,37
1070534	20-R $\frac{3}{4}$ "MT	80	10	St.	26,29
1070535	25-R $\frac{3}{4}$ "MT	40	5	St.	25,49
1070536	25-R1"MT	40	5	St.	31,24
1070537	32-R1"MT	20	5	St.	38,49

Uponor S-Press Winkelnippel

 1046909	40-R1 $\frac{1}{4}$ "MT	500	5	St.	65,78
--	-------------------------	-----	---	-----	--------------

Uponor S-Press PLUS Winkelmuffe

 1070539	16-Rp $\frac{1}{2}$ "FT	80	10	St.	13,68
1070540	20-Rp $\frac{1}{2}$ "FT	80	10	St.	23,13
1070541	20-Rp $\frac{3}{4}$ "FT	40	10	St.	24,17
1070542	25-Rp $\frac{3}{4}$ "FT	20	5	St.	29,88
1070543	25-Rp1"FT	20	5	St.	36,87
1070544	32-Rp1"FT	20	5	St.	47,07

Uponor S-Press Winkelmuffe

 1046910	40-Rp1 $\frac{1}{2}$ "FT	500	5	St.	66,80
1046912	50-Rp1 $\frac{1}{2}$ "FT	300	3	St.	78,27

Uponor S-Press PLUS Winkel 45°

 1070545	25-25	20	5	St.	29,02
1070546	32-32	20	5	St.	49,10

Uponor S-Press Winkel 45°

 1046913	40-40	500	5	St.	50,62
1046914	50-50	300	3	St.	69,63

Uponor S-Press PLUS Kupplung

 1070547	16-16	80	20	St.	8,60
1070548	20-20	80	10	St.	10,41
1070549	25-25	80	10	St.	15,91
1070550	32-32	40	5	St.	19,55

NEU Uponor S-Press PLUS Schiebekupplung

 1118706	16-16	80	10	St.	51,67
1118707	20-20	80	10	St.	60,30
1118708	25-25	40	5	St.	71,96
1118709	32-32	20	5	St.	78,11
1118710	40-40	12	3	St.	129,36

Art-Nr.	Dimension	LE	VE	ME	Preis/ME
---------	-----------	----	----	----	----------

Uponor S-Press Kupplung

 1046932	40-40	960	5	St.	34,11
1046935	50-50	576	3	St.	44,20

Uponor S-Press PLUS Kupplung reduziert

 1070552	20-16	80	20	St.	10,24
1070553	25-16	80	10	St.	15,67
1070554	25-20	80	10	St.	15,87
1070555	32-20	80	10	St.	19,80
1070556	32-25	80	10	St.	20,88

Uponor S-Press Kupplung reduziert

 1046930	40-25	960	5	St.	32,49
1046931	40-32	960	5	St.	32,88
1046933	50-32	1152	3	St.	38,52
1046934	50-40	576	3	St.	39,24

Uponor S-Press PLUS T-Stück

 1070560	16-16-16	80	10	St.	13,00
1070561	20-20-20	80	10	St.	17,52
1070562	25-25-25	20	5	St.	25,49
1070563	32-32-32	20	5	St.	42,61

Uponor S-Press T-Stück

 1046921	40-40-40	400	5	St.	59,63
1046928	50-50-50	300	3	St.	78,37

Uponor S-Press PLUS T-Stück reduziert

 1070566	16-20-16	80	10	St.	18,48
1070567	20-16-16	40	10	St.	18,48
1070568	20-16-20	80	20	St.	17,89
1070569	20-20-16	80	20	St.	17,89
1070570	20-25-16	40	10	St.	25,03
1070571	20-25-20	40	10	St.	25,03
1070572	25-16-16	40	5	St.	25,03
1070573	25-16-20	40	5	St.	25,03
1070574	25-16-25	20	5	St.	25,03
1070575	25-20-16	40	5	St.	25,03
1070576	25-20-20	40	5	St.	25,03
1070577	25-20-25	20	5	St.	25,03
1070578	25-25-16	20	5	St.	25,03
1070579	25-32-25	20	5	St.	47,65
1070580	32-16-32	20	5	St.	47,65
1070581	32-20-32	20	5	St.	47,65
1070582	32-25-25	20	5	St.	47,65
1070583	32-25-32	20	5	St.	47,65

Uponor S-Press PLUS

Installation
Trinkwasser- und Heizungsinstallation

Art-Nr.	Dimension	LE	VE	ME	Preis/ME
---------	-----------	----	----	----	----------

Uponor S-Press T-Stück reduziert

 1046916	40-20-40	400	5	St.	58,15
1046917	40-25-32	500	5	St.	51,83
1046918	40-25-40	400	5	St.	58,15
1046919	40-32-32	400	5	St.	53,34
1046920	40-32-40	400	5	St.	58,15
1046924	50-25-40	300	3	St.	77,84
1046925	50-25-50	240	3	St.	82,30
1046926	50-32-50	300	3	St.	82,31
1046927	50-40-50	300	3	St.	83,47

Uponor S-Press PLUS T-Stück m. Aussengew

 1070592	16-R $\frac{1}{2}$ "MT-16	40	10	St.	29,47
1070593	25-R $\frac{3}{4}$ "MT-25	20	5	St.	37,90
1070594	32-R $\frac{3}{4}$ "MT-32	20	5	St.	46,81

Uponor S-Press PLUS T-Stück m. Innengew.

 1070595	16-Rp $\frac{1}{2}$ "FT-16	40	10	St.	25,60
1070596	20-Rp $\frac{1}{2}$ "FT-20	60	15	St.	28,93
1070597	20-Rp $\frac{3}{4}$ "FT-20	40	10	St.	30,80
1070598	25-Rp $\frac{1}{2}$ "FT-25	20	5	St.	32,72
1070599	25-Rp $\frac{3}{4}$ "FT-25	20	5	St.	35,57
1070600	32-Rp $\frac{1}{2}$ "FT-32	20	5	St.	46,88
1070601	32-Rp $\frac{3}{4}$ "FT-32	20	5	St.	46,88

Uponor S-Press T-Stück mit Innengewinde

 1046922	40-Rp $\frac{1}{2}$ "FT-40	500	5	St.	54,54
1046923	40-Rp $\frac{3}{4}$ "FT-40	400	5	St.	54,54
1046929	50-Rp1"FT-50	240	3	St.	90,71

Art-Nr.	Dimension	LE	VE	ME	Preis/ME
---------	-----------	----	----	----	----------

Uponor S-Press PLUS Verschraubung IG

 1070602	16-G $\frac{1}{2}$ "SN	30	1	St.	18,74
1070603	16-G $\frac{3}{4}$ "SN	20	1	St.	22,56
1070604	20-G $\frac{1}{2}$ "SN	20	1	St.	20,58
1070605	20-G $\frac{3}{4}$ "SN	20	1	St.	25,28
1070606	25-G $\frac{3}{4}$ "SN	15	1	St.	28,67
1070607	25-G1"SN	15	1	St.	28,67
1070608	25-G1 $\frac{1}{4}$ " _„ SN	10	1	St.	32,93
1070609	32-G1"SN	10	1	St.	38,45
1070610	32-G1 $\frac{1}{4}$ "SN	10	1	St.	33,62

Uponor S-Press Verschraubung IG

 1060094	40-G1 $\frac{1}{4}$ "SN	960	5	St.	71,83
1046937	40-G1 $\frac{1}{2}$ "SN	960	5	St.	55,79
1060095	50-G1 $\frac{1}{2}$ "SN	1152	3	St.	75,82
1046938	50-G1 $\frac{3}{4}$ "SN	1152	3	St.	58,70
1046939	50-G2"SN	576	3	St.	63,93

Uponor S-Press PLUS Winkelverschraubung IG

 1070611	16-G $\frac{3}{8}$ "SN	20	1	St.	20,54
1070612	16-G $\frac{1}{2}$ "SN	20	1	St.	20,63
1070613	20-G $\frac{1}{2}$ "SN	20	1	St.	24,73
1070614	25-G $\frac{3}{4}$ "SN	10	1	St.	26,72

Uponor S-Press PLUS Wandscheibe M

 1070638	16-Rp $\frac{3}{8}$ "FT	40	10	St.	19,57
1070639	16-Rp $\frac{1}{2}$ "FT	40	10	St.	16,07
1070640	20-Rp $\frac{1}{2}$ "FT	40	10	St.	19,57
1070641	20-Rp $\frac{3}{4}$ "FT	20	5	St.	21,31
1070642	25-Rp $\frac{3}{4}$ "FT	20	5	St.	26,58

Uponor S-Press PLUS Wandscheibe L

 1070644	16-Rp $\frac{1}{2}$ "FT	40	10	St.	21,99
1070645	20-Rp $\frac{1}{2}$ "FT	40	10	St.	25,35

Uponor S-Press PLUS

Art-Nr.	Dimension	LE	VE	ME	Preis/ME
---------	-----------	----	----	----	----------

Uponor S-Press PLUS Wandscheibe XL

 1070646	16-Rp $\frac{1}{2}$ "FT	40	10	St.	26,84
1070647	20-Rp $\frac{1}{2}$ "FT	40	10	St.	28,26

Uponor Smart Aqua Schallset 2 Wandsch.

 OUT 1057846		384	1	Set	14,52
--	--	-----	---	-----	--------------

Uponor S-Press PLUS U-Wandscheibe

 1070629	16-Rp $\frac{1}{2}$ "FT-16	20	5	St.	39,96
1070630	20-Rp $\frac{1}{2}$ "FT-20	960	5	St.	49,72
1070631	20-Rp $\frac{1}{2}$ "FT-16	960	5	St.	55,85
1070632	16-Rp $\frac{1}{2}$ "FT-20	960	5	St.	55,85
1070633	25-Rp $\frac{1}{2}$ "FT-25	576	3	St.	82,46
1070634	25-Rp $\frac{1}{2}$ "FT-20	576	3	St.	82,46
1070635	20-Rp $\frac{1}{2}$ "FT-25	576	3	St.	82,46

Uponor Smart Aqua Schallset 1 U-Wandsch.

 OUT 1060367		8	1	St.	15,47
---	--	---	---	-----	--------------

Uponor S-Press PLUS U-Armaturenanschluss

 1070636	16-16-R $\frac{1}{2}$ "MT	960	5	St.	52,88
1070637	20-20-R $\frac{3}{4}$ "MT	960	5	St.	56,37

Uponor S-Press PLUS Doppel-Wandscheibe 90° L

 1070648	16-Rp $\frac{1}{2}$ "FT-16	40	10	St.	36,52
1070649	20-Rp $\frac{1}{2}$ "FT-20	40	10	St.	42,71

Uponor S-Press PLUS Anschlusswinkel flach

 1070657	16-Rp $\frac{1}{2}$ "FT	10	1	St.	26,50
--	-------------------------	----	---	-----	--------------

Uponor S-Press PLUS SK-T-Stück Geberit

 1070659	16-G $\frac{1}{2}$ "FT-16	10	1	St.	31,55
--	---------------------------	----	---	-----	--------------

Uponor S-Press PLUS SK-Winkelverschraub. Geberit

 1070658	16- $\frac{1}{2}$ "FT	80	20	St.	16,81
--	-----------------------	----	----	-----	--------------

Art-Nr.	Dimension	LE	VE	ME	Preis/ME
---------	-----------	----	----	----	----------

Uponor Smart Aqua SK-Verschraubung Geberit

 1058097	16- $\frac{1}{2}$ "FT	25	1	St.	10,11
--	-----------------------	----	---	-----	--------------

Uponor S-Press PLUS Endstück

 1070621	16	160	40	St.	8,27
1070622	20	7680	20	St.	14,01
1070623	25	3840	10	St.	16,13
1070624	32	1920	5	St.	20,46

Uponor MLC Abdrückstopfen

 1013754	14	7680	20	St.	18,83
1013756	16	7680	20	St.	18,83
1013760	20	3840	20	St.	20,29
1013762	25	3840	10	St.	22,22
1013764	32	3840	10	St.	34,11
1013765	40	960	5	St.	43,65

Uponor MLC O-Ring für Abdrückstopfen

 1013798	14	10000	10	St.	0,46
1013799	16	1000	10	St.	0,59
1013801	20	1000	10	St.	0,82
1013802	25	500	10	St.	0,93
1013803	32	500	10	St.	0,93
1013804	40	10000	10	St.	1,26

Uponor S-Press PLUS

Installation
Trinkwasser- und Heizungsinstallation

Art-Nr.	Dimension	LE	VE	ME	Preis/ME
---------	-----------	----	----	----	----------

Uponor S-Press PLUS Montageeinheit mit Schallset

 1070666	16-Rp½"FT c/c150mm	5	1	St.	61,26
--	--------------------	---	---	-----	--------------

Uponor S-Press PLUS Montageeinheit

 1070661	16-Rp½"FT c/c80mm	5	1	St.	46,35
1070662	16-Rp½"FT c/c150mm	5	1	St.	46,35

Uponor S-Press PLUS Montageeinheit Gemini

 1070663	16-Rp½"FT c/c120mm	720	5	St.	46,64
1070664	16-Rp½"FT c/c150mm	720	5	St.	46,64

Uponor Smart Aqua Montageplatte

 1057840	75/150mm	5	1	St.	7,92
--	----------	---	---	-----	-------------

Uponor Smart Aqua Montagewinkel

 1057841	80mm	5	1	St.	6,41
1057839	100mm	5	1	St.	7,77
1057842	75/150mm	5	1	St.	8,63

Uponor Smart Aqua Montagewinkel Gemini

 1059824	120mm	5	1	St.	6,62
1059825	150mm	5	1	St.	7,00

Uponor Smart Aqua Einzelmontagewinkel

 1057843		5	1	St.	7,48
--	--	---	---	-----	-------------

Uponor Smart Aqua Montageschiene

 1057844	2m	10	1	St.	37,56
--	----	----	---	-----	--------------

Uponor Smart Aqua 10 Bolzen+20 Schrauben

 1057847		-	1	Set	12,56
--	--	---	---	-----	--------------

Art-Nr.	Dimension	LE	VE	ME	Preis/ME
---------	-----------	----	----	----	----------

Uponor S-Press PLUS Mauerdurchführung

 1070652	16-G½"FT	5	1	St.	29,03
--	----------	---	---	-----	--------------

Uponor S-Press PLUS Wanddurchführung Eck LWC

 1070653	16-Rp½"FT l=25	5	1	St.	51,40
1070654	16-Rp½"FT l=35	5	1	St.	52,49

Uponor S-Press PLUS U-Wanddurchführung Eck LWC

 1070655	16-Rp½"FT-16 l=25	5	1	St.	74,27
1070656	16-Rp½"FT-16 l=35	5	1	St.	75,48

Uponor Smart Aqua Verdrehsicherung LWC

 1083955		80	10	St.	5,45
--	--	----	----	-----	-------------

Uponor Smart Aqua Dichtflansch LWC

 1084151		50	10	St.	3,60
---	--	----	----	-----	-------------

Die Uponor Wanddurchführungen sind auf Anfrage für Projektierungen auch in 20 mm erhältlich. Der Uponor S-Press Anschluss kann auch mit der RTM-Technologie oder als Q&E-Verbindung in 16 und 20 mm geliefert werden. Sonderlängen der Einbautiefe, sind von 35mm bis 65mm, in mm Schritten möglich.

Uponor S-Press PLUS Übergangsnippel

Art-Nr.	Dimension	LE	VE	ME	Preis/ME
---------	-----------	----	----	----	----------

Uponor S-Press Übergangskupplung auf Polyfix

 1015168	16-16	80	20	St.	15,83
1015192	20-20	3840	10	St.	16,56
1015210	25-26	1920	5	St.	23,70
1015224	32-32	1920	5	St.	27,59

Uponor S-Press Übergangskupplung auf Rapex

 1015167	16-16	80	20	St.	15,83
1015190	20-20	3840	10	St.	16,56
1015208	25-26	1920	5	St.	23,25
1015222	32-32	1920	5	St.	26,99

Uponor S-Press Kupplung auf Edelstahl/CU V

 1090678	16-15CU-SST	10	1	St.	20,10
1090679	20-22CU-SST	5	1	St.	29,26
1090680	25-22CU-SST	5	1	St.	31,18
1090681	32-28CU-SST	5	1	St.	44,18

Uponor S-Press Kupplung auf Edelstahl/CU M

 1090682	16-15CU-SST	10	1	St.	20,10
1090683	20-22CU-SST	5	1	St.	29,26
1090684	25-22CU-SST	5	1	St.	31,18
1090685	32-28CU-SST	5	1	St.	44,18

Art-Nr.	Dimension	LE	VE	ME	Preis/ME
---------	-----------	----	----	----	----------

Uponor S-Press PLUS Übergang auf Kupfer

 1070705	16-10CU	80	20	St.	13,29
1070706	16-12CU	80	20	St.	13,35
1070615	16-15CU	160	20	St.	13,47
1070616	20-18CU	40	10	St.	17,74
1070617	20-22CU	60	15	St.	18,23
1070618	25-22CU	20	5	St.	21,96
1070620	32-28CU	20	5	St.	33,25

Uponor S-Press Kupplung reduziert

 1015172	18-16	80	20	St.	12,25
1015185	20-18	80	10	St.	13,82

Installation

Trinkwasser- und Heizungsinstallation

Uponor S-Press PLUS Edelstahl

Art-Nr.	Dimension	LE	VE	ME	Preis/ME
---------	-----------	----	----	----	----------

Uponor S-Press Übergangsnippel Edelstahl

 1090686	16-R½"MT	10	1	St.	35,04
1090687	20-R¾"MT	10	1	St.	38,89
1090688	25-R¾"MT	5	1	St.	54,53

Uponor S-Press Übergangsmuffe Edelstahl

 1090689	25-Rp¾"FT	5	1	St.	58,39
1090690	32-Rp1"FT	5	1	St.	77,78

Uponor S-Press Übergang auf Edelstahl SST

 1089056	16-15SST	10	1	St.	17,40
1089057	20-22SST	10	1	St.	24,63
1089058	25-22SST	5	1	St.	25,23
1089059	32-28SST	5	1	St.	37,92

Art-Nr.	Dimension	LE	VE	ME	Preis/ME
---------	-----------	----	----	----	----------

Uponor Smart Aqua U-Wandscheibe Edelstahl S-Press

 1090691	16-Rp½"FT-16	5	1	St.	110,29
1090692	20-Rp½"FT-20	5	1	St.	116,79

Uponor Smart Aqua Wandscheibe Edelstahl S-Press

 1090693	16-Rp½"FT	10	1	St.	62,25
1090694	20-Rp½"FT	10	1	St.	73,92

OUT Lieferung solange Vorrat reicht.
Artikel läuft im Laufe des Jahres aus.

Uponor Smart ISI Installationsboxen

Installation

Trinkwasser- und Heizungsinstallation

Art-Nr.	Dimension	LE	VE	ME	Preis/ME
---------	-----------	----	----	----	----------

Uponor Smart ISI Waschtisch WT

 1061610*	16-Rp½"FT, c/c=80mm DN50	24	1	Set	Preis auf Anfrage
---	-----------------------------	----	---	-----	------------------------------

Uponor Smart ISI Waschtisch WT-U

 1061615*	16-Rp½"FT, c/c=80mm DN50	24	1	Set	Preis auf Anfrage
---	-----------------------------	----	---	-----	------------------------------

Uponor Smart ISI Spültisch ST

 1061611*	16-Rp½"FT, c/c=160mm DN50	12	1	Set	Preis auf Anfrage
---	------------------------------	----	---	-----	------------------------------

Uponor Smart ISI Spültisch ST-U

 1061616*	16-Rp½"FT, c/c=160mm DN50	12	1	Set	Preis auf Anfrage
--	------------------------------	----	---	-----	------------------------------

Uponor Smart ISI Badarmatur BA

 1061612*	16-Rp½"FT, c/c=150mm DN50	24	1	Set	Preis auf Anfrage
---	------------------------------	----	---	-----	------------------------------

Art-Nr.	Dimension	LE	VE	ME	Preis/ME
---------	-----------	----	----	----	----------

Uponor Smart ISI Badarmatur BA-U

 1061617*	16-Rp½"FT, c/c=150mm DN50	24	1	Set	Preis auf Anfrage
---	------------------------------	----	---	-----	------------------------------

Uponor Smart ISI Waschmaschine WM

 1061613*	16-Rp½"FT, DN50, HL400	12	1	Set	Preis auf Anfrage
---	------------------------	----	---	-----	------------------------------

Uponor Smart ISI Waschmaschine WM-U

 1061618*	16-Rp½"FT, DN50, HL400	12	1	Set	Preis auf Anfrage
---	------------------------	----	---	-----	------------------------------

Uponor Smart ISI Waschtischbefestigung WT



 1061614*		50	1	Set	Preis auf Anfrage
---	--	----	---	-----	------------------------------

Baustellenbezogene Lieferung von Uponor Smart ISI Boxen in Sonderausführungen sind möglich.



Uponor S-Press PLUS Heizung

Art-Nr.	Dimension	LE	VE	ME	Preis/ME
---------	-----------	----	----	----	----------



Uponor S-Press PLUS HK-Kreuzfitting mit Dämmbox

 1070689	16-16-16	192	1	St.	60,29
 1070690	20-16-16	192	1	St.	67,34
 1070691	20-16-20	192	1	St.	67,34
 1070692	20-20-20	192	1	St.	65,57



Uponor Smart Radi Anschlussblock

 1013134	16 h=215mm	240	10	St.	37,51
 1007077	16 h=240mm	240	10	St.	46,95







Uponor S-Press PLUS HK-Anschlusswinkel

 1070678	16-15CU l=350mm	1680	20	St.	19,03
 1070679	16-15CU l=1000mm	400	20	St.	34,83

Uponor S-Press PLUS HK-Anschl. T-Stück

 1070681	16-15CU-16 l=350mm	600	20	St.	33,05
 1070682	20-15CU-20 l=350mm	600	20	St.	42,65



Uponor S-Press PLUS SL-Anschlussgarnitur

 1070693	16-G½"MT-16	192	1	St.	70,52
 1070694	16-G½"MT-20	192	1	St.	77,21
 1070695	16-G½"MT-0	192	1	St.	69,11
 1070696	20-G½"MT-16	192	1	St.	77,21
 1094219	0-G½"MT-16	192	1	St.	69,11
 1070697	20-G½"MT-20	192	1	St.	77,21

Uponor Smart Base SL-Winkel SL

 1014060	15x1	25	1	Set	51,47
--	------	----	---	-----	--------------

Uponor S-Press PLUS HK-Montageplatte radi

 1070683	16-Rp½"FT c/c35mm	720	5	St.	46,29
 1070684	16-Rp½"FT c/c50mm	720	5	St.	46,29

Uponor Smart Radi Anschlussrohr

 1015425	G½"MT-15CU l=350mm	640	20	St.	25,91
--	--------------------	-----	----	-----	--------------

Art-Nr.	Dimension	LE	VE	ME	Preis/ME
---------	-----------	----	----	----	----------

Uponor Smart Radi Klemmverschraubung Cu

 1013830	15CU-¾" Euro	80	10	St.	6,06
--	--------------	----	----	-----	-------------

Uponor Smart Radi Anschlussnippel

 1013906	G¼"MT-G½"MT	80	10	St.	4,40
--	-------------	----	----	-----	-------------

Uponor Smart Radi Anschlussgarnitur Danfoss

 1013970	16-G½"MT	20	1	St.	6,99
--	----------	----	---	-----	-------------

Uponor Smart Radi Anschlussgarnitur Heimeier

 1013978	16-G½"MT	20	1	St.	6,99
--	----------	----	---	-----	-------------

Uponor Smart Radi Anschlussgarnitur Oventrop

 1014016	16-G½"MT	20	1	St.	6,99
--	----------	----	---	-----	-------------

Uponor Smart Radi Anschlussset

 1011364		100	10	St.	12,68
--	--	-----	----	-----	--------------

Uponor Smart Radi Rosette weiß

 1011370	16	20000	50	St.	0,70
--	----	-------	----	-----	-------------

Uponor Smart Radi Stufen-Doppelrosette

 1011373	14-20	500	50	St.	2,61
--	-------	-----	----	-----	-------------

Uponor S-Press Thermostatventil Aquastrom T plus

 1013243	G¼"MT	300	1	St.	210,29
--	-------	-----	---	-----	---------------

Uponor RS

Verteil- und Steigleitungen 63-110 mm

Installation

Verteil- und Steigleitungen 63-110 mm

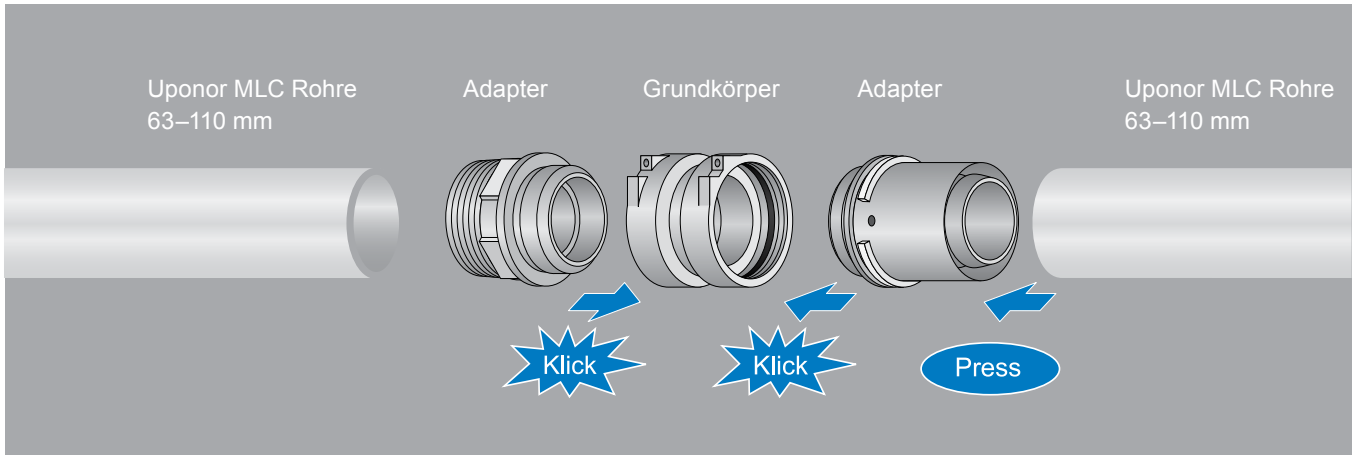

RS 2 Adapter	RS 2 Grundkörper	RS 3 Grundkörper	RS 3 Adapter
<ul style="list-style-type: none"> 40, 50, 63, 75 1½", 2", 2½" ½", 1", 2", 2½" 16, 20, 25, 32 DN 65 (PN 6/PN 16) 130 mm 5 mm 	<ul style="list-style-type: none"> 	<ul style="list-style-type: none"> 	<ul style="list-style-type: none"> 90, 110 3" ½", 3" DN 80 (PN 6/PN 16) DN 100 (PN 6/PN 16) 210 mm 5 mm
<p>RS 2 / RS 3</p>			

Uponor RS

Art-Nr.	Dimension	LE	VE	ME	Preis/ME
---------	-----------	----	----	----	----------

Uponor RS Kupplung

 1029144	RS2-RS2	480	1	St.	30,54
1029145	RS3-RS3	480	1	St.	58,83

Uponor RS Winkel

 1029138	RS2-RS2	336	1	St.	40,86
1029139	RS3-RS3	240	1	St.	77,36

Uponor RS Winkel 45°

 1029140	RS2-RS2	336	1	St.	48,53
1029141	RS3-RS3	175	1	St.	92,66

Uponor RS T-Stück

 1029142	RS2-RS2-RS2	336	1	St.	49,09
1029143	RS3-RS3-RS3	175	1	St.	117,65

Uponor RS Kupplung reduziert

 1029146	RS3-RS2	480	1	St.	43,65
---	---------	-----	---	-----	--------------

Uponor RS Distanzadapter

 1046750	RS2-RS2 l=5mm	480	1	St.	36,10
1046751	RS3-RS3 l=5mm	240	1	St.	57,38

Uponor RS Distanzadapter

 1046477	RS2-RS2 l=130mm	240	1	St.	70,01
1046478	RS3-RS3 l=210mm	96	1	St.	157,58

Uponor RS Adapter S-Press

 1059397	16-RS2	480	1	St.	31,98
--	--------	-----	---	-----	--------------

Uponor RS Adapter S-Press PLUS

 1095818	20-RS2	378	1	St.	32,49
1095819	25-RS2	378	1	St.	32,49
1095820	32-RS2	378	1	St.	32,49

Art-Nr.	Dimension	LE	VE	ME	Preis/ME
---------	-----------	----	----	----	----------

Uponor RS Adapter S-Press

 1046940	40-RS2	480	1	St.	31,98
1046941	50-RS2	480	1	St.	33,58
1029125	63-RS2	400	1	St.	36,45
1029126	75-RS2	400	1	St.	61,34
1029127	90-RS3	240	1	St.	102,82
1029128	110-RS3	240	1	St.	122,20

Uponor RS Gewindeadapter Nippel

 1059402	R1 ½"MT-RS2	480	1	St.	40,09
1029131	R2"MT-RS2	480	1	St.	36,10
1029132	R2 ½"MT-RS2	480	1	St.	61,34
1029133	R3"MT-RS3	240	1	St.	45,49

Uponor RS Gewindeadapter Muffe

 1059403	Rp½"FT-RS2	480	1	St.	29,81
1029134	Rp1"FT-RS2	480	1	St.	27,51
1029135	Rp2"FT-RS2	480	1	St.	31,08
1029136	Rp2 ½"FT-RS2	480	1	St.	70,85
1059404	Rp½"FT-RS3	336	1	St.	45,47
1029137	Rp3"FT-RS3	240	1	St.	42,20

Uponor RS Flansch Adapter

 1059398	RS2-DN65 (PN6)	144	1	St.	211,30
1059399	RS2-DN65 (PN16)	90	1	St.	226,10
1059400	RS3-DN80 (PN6)	90	1	St.	228,42
1029129	RS3-DN80 (PN16)	90	1	St.	235,19
1059401	RS3-DN100 (PN6)	90	1	St.	250,08
1029130	RS3-DN100 (PN16)	90	1	St.	258,06

Uponor RS Verriegelungselement

 1042921	RS2 schwarz	5000	10	St.	19,41
1042922	RS3 grau	-	10	St.	44,53

Preis pro VPE

Flächenheizung/-kühlung









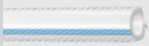

	Installationsart	System-Platten-dicke	Mindest-Aufbau-höhe* mm	Systemname	Beschreibung	Zugehörige Systemrohre	Dimension (mm)	
BODEN	NASSBAU	Noppenplattenverlegung, selbstklebend	—	15	Uponor Minitec	sehr geringe Aufbauhöhe, direkt auf altem Untergrund (Estrich, Fliesen, Holz..)	Comfort Pipe	9,9
		Kletten	DES 25-2, 30-2, 30-3, 35-3 WLS032 25-2, DEO 15	74	Uponor Klett	Mikroverzahnung von Systemplatte und Rohr. Schnellste Verlegeart, keine Beschädigung der Estrichfolie	Klett Comfort Pipe PLUS Klett MLCP RED	14, 16 16
		Kletten auf bauseitiger Dämmung	—	74	Uponor Klett Twinboard	Klettverlegung auf bauseitiger Dämmung mittels Hohlkammer-Verlegeplatten 3 mm	Klett Comfort Pipe PLUS Klett MLCP RED	14, 16 16
		Kletten inkl. Mineralwolle-Dämmung	30	74	Uponor Klett Silent	Klettverlegung auf Mineralwolleplatten, alternative Ausschreibungen, "Blauer Engel" für emissionsarme Produkte	Klett Comfort Pipe PLUS Klett MLCP RED	14, 16 16
		Kletten inkl. Lüftung	30	74	Uponor Comfort AIR	Integration von Lüftung und Fußbodenheizung durch Anbindung an das Pluggit-Lüftungssystem	Klett Comfort Pipe PLUS Klett MLCP RED	14, 16 16
		Klett Vermeidung überheizte Flure	32	74	Vario Heat Protect	Rohrträger zur Führung von FBH-Anschlussleitungen unter der Heizestrichschicht	alle Rohrleitungen zum Verteiler	
		In der Noppenfolie	—	30	Uponor Nubos	Freie Wahl der Dämmschicht	Comfort Pipe MLCP RED	16 14, 16
		In der Noppenplatte	11 oder 30-2	82	Uponor Tecto	Schnelle Rohrmontage, Systemplatten für Geschosstrenndecken, sicherer Halt	Comfort Pipe PLUS MLCP RED	14, 17 14, 16
		In der Noppenplatte	11 oder 30-2	78	Uponor Nubos	Einfach in der Anwendung, normgerechte Verlegeabstände	Comfort Pipe MLCP RED	16 14, 16
		auf Stahlmatten mit Clip	—	83	Uponor Classic	Höchster Schallschutz (bauseitige Mineralwöldämmung). Trennung der Gewerke Estrich/Heizung, große Heizkreise	Comfort Pipe PLUS Magna Pipe PLUS	17 20
		Tacker und U-Schiene	EPS DEO 20, 26, 30 WLS040 50 DES 20-2, 25-2, 30-2, 30-3, 35-3, 40-3 WLS032 25-2	75	Uponor Tacker	Preiswerteste Lösung. Unterschiedliche Wärme-/Trittschalldämmschichten lieferbar	Comfort Pipe MLCP RED	16 14, 16
TROCKEN	In vorgeformte EPS-Platten und Alu-Wärmeleitlamellen	25	50	Uponor Siccus 14	geringes Gewicht, sofort nutzbar, hohe Tragfähigkeit	Comfort Pipe PLUS MLCP RED	14 14	
	Mit vorgefertigten Kabelmatten, elektrische FBH	—	5	Uponor Comfort E Folie AL	Fest vernähte Kabelmatte mit Aluminiumfolie, sehr geringe Aufbauhöhe, Verlegung auf nahezu allen festen Unterböden, inkl. Regler, schnelle Reaktion	—		
	Mit vorgefertigten Kabelmatten, elektrische FBH	—	5	Uponor Comfort E Kabelmatten	Fest vernähte Kabelmatte, sehr geringe Aufbauhöhe, Verlegung auf nahezu allen festen Unterböden, inkl. Regler, schnelle Reaktion	—		

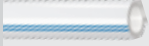
Uponor Systeme zum Heizen und Kühlen

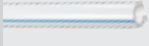
		Installationsart	System-Platten-dicke	Min-dest-Aufbau-höhe* mm	Systemname	Beschreibung	Zugehörige Systemrohre	Dimen-sion (mm)
WAND	NASS	Unter Putz, mit Klemmschiene	—	32	Uponor Fix	Effiziente und drallfreie Rohrverlegung von der Großrolle mit minimalem Verschnitt	Comfort Pipe Comfort Pipe PLUS MLCP RED	9,9 14 14
		In vorgeformten EPS-Platten	25	30	Uponor Siccus Wall	Keine Trocknungszeiten und kein Funktionsheizen erforderlich	Comfort Pipe PLUS MLCP RED	14 14
	TROCKEN	Für Ständerwände, in Modulbauweise	—	32	Uponor Siccus SW	Doppelnutzen durch Nutzung von Ständerwänden als Heiz-/Kühlflächen	Comfort Pipe PLUS	14
		Auf CD-Profile 60/27, Gipspanel mit integrierten Heizrohren	—	15	Uponor Renovis	Faserverstärkte Gipsplatte 15 mm, Montage auf definierte Trockenbau-Unterkonstruktionen	Comfort Pipe (integriert)	9,9
DECKE	NASS	Unter Putz, mit Klemmschiene	—	32	Uponor Fix	Effiziente und drallfreie Rohrverlegung von der Großrolle mit minimalem Verschnitt	Comfort Pipe	9,9
		Auf CD-Profile 60/27, Gipspanel mit integrierten Heizrohren	—	15	Uponor Renovis	Hohe Verlegeleistungen auf CD-Profilen	Comfort Pipe (integriert)	9,9
	TROCKEN	Gipspanel inkl. EPS-Dämmung	27	27	Uponor Teporis	27 mm EPS Wärmedämmplatte	Comfort Pipe (integriert)	9,9
		Standard Unterkonstruktionen	—	15	Uponor Thermatop M	Fugen- und richtungslose Deckenoberflächen	Uni Pipe PLUS	16
WEITERE ANWENDUNGEN	HALLEN	INDUSTRIEFLÄCHENHEIZUNG						
		auf Klemmschiene			Uponor Magna	Optimale Raumnutzung ohne störende Anlagenkomponenten	Magna Pipe PLUS	20, 25
		auf Stahlmatten						
	TABS	BETONKERNAKTIVIERUNG						
		Vorgefertigte Module auf Stahlmatte (Bewehrung)			Uponor Contec	Für die Einbringung in den Betonkern	Magna Pipe PLUS	20
		Oberflächennah			Uponor Contec ON	Diagonal verspannte Wabengitter mit vorbereiteten Rohren zum oberflächennahen Einbau in die Betonschalung	Comfort Pipe PLUS	14
	TROCKEN	SPORTBODEN						
		In Sporthallen	30		Uponor Siccus Sport	für flächenelastische Sportböden in Sandwichbauweise	Comfort Pipe PLUS MLC weiß	14 14
		In Sporthallen			Uponor Sport	Zum Einbau zwischen Unterzügen flächenelastischer Sportböden	Magna Pipe PLUS	25
	FREIFLÄCHE	FREIFLÄCHENHEIZUNG / RASEN						
Schnee- und Eisfreihaltung auf Freiflächen				Uponor Meltaway	Montage mit Klemmschiene, für sichere Gehwege z.B. vor Krankenhauseinfahrten, Hubschrauberlandeplätzen, Tiefgaragen- und Hofeinfahrten, Flugplätzen usw.	Magna Pipe PLUS	20, 25	

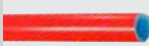
Flächenheizung/-kühlung

Uponor Heizrohre und Verbindungstechniken

Typ	Ab- messung [mm]	Diffusionssperre	Rohrfarbe, Kennzeichnung	Druck [bar]	Tempe- ratur [°C]	Länge [m]	Artikel-Nr.	DIN- Certco Zerti- fikat-Nr.
Comfort Pipe PLUS 	14 x 2,0	PE-Xa + EVOH Sperrschicht	weiß, 2 blaue Streifen	8	70	120 240 960	1062883 1062884 1062885	3V372
	17 x 2,0	PE-Xa + EVOH Sperrschicht	weiß, 2 blaue Streifen	8	70	120 240 480 640	1034535 1009226 1086340 1009227	3V372
	20 x 2,0	PE-Xa + EVOH Sperrschicht	weiß, 2 blaue Streifen	6	70	60	1009229	3V372
	25 x 2,3	PE-Xa + EVOH Sperrschicht	weiß, 2 blaue Streifen	6	70	60	1062887	3V372
Klett Comfort Pipe PLUS 	14 x 2,0	PE-Xa + EVOH Sperrschicht	weiß, 2 blaue Streifen, mit Klettband	8	70	240 640	1088479 1088480	3V372
	16 x 2,0	PE-Xa + EVOH Sperrschicht	weiß, 2 blaue Streifen, mit Klettband	8	70	240 640	1087302 1087303	3V372
Magna Pipe PLUS 	20 x 2,0	PE-Xa + EVOH Sperrschicht	weiß, 2 blaue Streifen	6	70	240 480	1091275 1091276	3V415
	25 x 2,3	PE-Xa + EVOH Sperrschicht	weiß, 2 blaue Streifen	6	70	300 640	1091277 1091278	3V415
Comfort Pipe 	16 x 1,8	PE-Xa + EVOH Sperrschicht	weiß, 1 blauer Streifen	6	70	240 640	1047622 1047623	3V417
Minitec Comfort Pipe 	9,9 x 1,1	PE-Xa + EVOH Sperrschicht	natur, 1 blauer Streifen	6	70	60 120 480	1063287 1063288 1063381	3V279
MLC Rohr weiß 	14 x 2,0	Verbundrohr mit AL	weiß	10	80	200	1013366	
MLCP RED 	 14 x 1,6	Verbundrohr mit AL	rot, innen blau	4	60	240 480	1096010 1096011	3V286
	 16 x 2,0	Verbundrohr mit AL	rot, innen blau	4	60	240 480	1096012 1096013	3V286
MLCP RED Klett 	16 x 2,0	Verbundrohr mit AL	weiß, innen blau, 2 rote Streifen, mit Klettband	4	60	240 480	1096014 1096015	3V286

Verbindungstechnik, Fittings und Werkzeug für Flächenheizsysteme

(Klemmring-) Verschraubungen



Maulschlüssel handelsüblich



Quick und Easy Fittings



Q+E-Aufweitwerkzeuge



zugehörige Q+E-Sicherungsringe



rapex Pressfittings



rapex Pressbacken



Smart Presskupplungen



Pressbacken MLC UPP1 und KSP0



S-Press und S-Press-PLUS Kupplungen



Vario/Fit
14x2,0

M12 & M18

natur eval

14

14

-

Vario/Fit
17x2,0

M12 & M18

natur eval & weiß

17

-

-

Vario/Fit
20x1,9/2,0

M12 & M18

natur eval & weiß

-

20

-

Vario/Fit
25x2,3

M12 & M18

natur eval & weiß

25

-

-

Vario/Fit
14x2,0

M12 & M18

natur eval

14

14

-

Vario/Fit
16x1,8/2,0

M12 & M18

natur eval & weiß

16

16

-

Vario/Fit
20x1,9/2,0

M12 & M18

natur eval & weiß

-

20

-

Vario/Fit
25x2,3

M12 & M18

natur eval & weiß

25

-

-

Vario/Fit 16x1,8/2,0

M12 & M18

natur eval & weiß

16

16

-

Vario & Minitec
9,9 x 1,1

Hand,
M12 & M18

Minitec PEX

-

-

-

Uni-X
14-3/4 Euro

-

-

-

-

14

Vario MLCP RED
14x1,6 Euro

-

-

-

-

14
MLCP RED
Press-Kupplung

Uni-X
16-3/4 Euro

-

-

-

-

16

Uni-X
16-3/4 Euro

-

-

-

-

16

Uponor Minitec

Art-Nr.	Dimension	LE	VE	ME	Preis/ME
---------	-----------	----	----	----	----------

Uponor Minitec Folienelement

 1005261	9,9x1,1 1100x700x12mm	123,2	15,4	m ²	28,88
--	--------------------------	-------	------	----------------	--------------

Uponor Fix Klemmschiene

 1005274	9,9mm c/c20mm 2,5m	25	2,5	m	5,02
--	--------------------	----	-----	---	-------------

Uponor Minitec Randdämmstreifen klebend

 1005267	20m 80x8mm	200	20	m	1,33
--	------------	-----	----	---	-------------

Uponor Minitec Bewegungsfugenprofil

 1085980	0,9m 40x10mm	600	10	St.	8,76
1085981	1,3m 40x10mm	600	10	St.	11,10

Uponor Minitec Rohr Comfort Pipe

 1063287	9,9x1,1 60m	840	60	m	2,88
1063288	9,9x1,1 120m	1680	120	m	2,88
1063381	9,9x1,1 480m	2880	480	m	2,88

Uponor Minitec Schutzhülse

 1005269	9,9mm 300x2mm	3600	30	St.	1,43
--	---------------	------	----	-----	-------------

Uponor Vario Eurokonusverschraubung Minitec

 1005266	9,9x1,1-G $\frac{3}{4}$ "Euro	100	10	St.	9,02
--	-------------------------------	-----	----	-----	-------------

Uponor Minitec Kupplung

 1005264	9,9x1,1	100	10	St.	7,82
--	---------	-----	----	-----	-------------

Uponor Minitec Übergangsnippel

 1005265	9,9-R $\frac{1}{2}$ "MT	100	10	St.	9,60
--	-------------------------	-----	----	-----	-------------

Uponor Minitec Ring

 1005263	9,9x1,1	1600	10	St.	0,35
--	---------	------	----	-----	-------------

Uponor Minitec Klemmringverschraubung

 1013426	9,9- $\frac{3}{4}$ "Euro	120	12	St.	15,12
--	--------------------------	-----	----	-----	--------------

Uponor Minitec Schraubkupplung

 1016690	9,9-9,9	120	12	St.	35,98
--	---------	-----	----	-----	--------------

Art-Nr.	Dimension	LE	VE	ME	Preis/ME
---------	-----------	----	----	----	----------

Uponor Fluvia T Pumpengruppe Push-12 TH-G

 1095127		60	1	St.	589,21
--	--	----	---	-----	---------------

Uponor Fluvia T Pumpengruppe Push-12 CH-G

 1095131		30	1	St.	1387,11
--	--	----	---	-----	----------------

Uponor Fluvia T Pumpengruppe Push-12 AC-G

 1095128		60	1	St.	698,75
--	--	----	---	-----	---------------

Uponor Fluvia T Pumpengruppe Push-12 WL-G

 1095130		60	1	St.	933,33
--	--	----	---	-----	---------------

Uponor Fluvia Hosenstück

 1005675	2xG $\frac{3}{4}$ - $\frac{3}{4}$ "Euro	50	1	Set	34,42
--	---	----	---	-----	--------------

Uponor Vario Füll-Entleerungshahn

 1061802	$\frac{3}{4}$ " - $\frac{3}{4}$ "	10	1	Set	56,21
--	-----------------------------------	----	---	-----	--------------

Uponor Minitec Anschlussbox-UP

 1005270	1X	30	1	St.	281,58
1005271	2X	-	1	St.	394,23
1005272	3X	-	1	St.	416,14

Die Begrenzung der Auslegungstemperatur muss durch eine Vorregelung sichergestellt sein.

Uponor Minitec Abdeckplatte

 1007251		-	1	St.	114,73
--	--	---	---	-----	---------------

Uponor Base Raumfühler T-23

 1058422	230V RAL9010	160	1	St.	42,45
--	--------------	-----	---	-----	--------------

Uponor Minitec Aufweitwerkzeug

 1006247	9,9x1,1	11	1	Set	298,91
--	---------	----	---	-----	---------------











Uponor Q&E Aufweitwerkzeug mit Aufweitk. M12















 1063112	6BAR 9,9/20	-	1	Set	505,48
--	-------------	---	---	-----	---------------

Uponor Q&E Aufweitkopf M12

 1060702	9,9x1,1	-	1	St.	113,13
--	---------	---	---	-----	---------------

Uponor Tecto

Art-Nr.	Dimension	LE	VE	ME	Preis/ME
Uponor Tecto Noppenplatte					
 1005478	EPS DES 30-2mm 14-17mm 1450x850mm	53,76	1,8	m ²	20,55
Uponor Tecto Noppenplatte					
 1005477	EPS 11mm 14-17mm 1450x850mm	94,08	15,68	m ²	18,88
Uponor Tecto Diagonal-Rohrfixierung					
1005482	45° 75mm	1680	10	St.	1,73
Uponor Tecto Zwillingstreifen					
1005484	1,4m 100mm	742,5	33,75	m	3,11
Uponor Tecto Abdeckfolie					
 1005481	1,45m 200mm	504	28	m	3,29
Uponor Tecto Dämmstreifen					
 1005480	EPS DES 30-2mm 150x1400mm	268,8	8,4	m	4,82
Uponor Tecto Dämmstreifen					
 1005479	EPS 11mm 150x1400mm	716,8	22,4	m	4,25
Uponor Multi Randdämmstreifen mit Folie					
 1000079	150x8mm	-	200	m	1,12
<i>Hinweis: Verkauf pro Verpackungseinheit.</i>					
Uponor Multi Randdämmstreifen Klebefolie					
 1000080	150x10mm	-	200	m	2,28
<i>Hinweis: Verkauf pro Verpackungseinheit.</i>					
Uponor Multi Dehnungsfugenprofil					
 1090229	1800x100x10mm	720	18	m	10,48
Uponor Multi Schutzhülse					
 1000082	20mm 300x5mm	1800	30	St.	1,01
Uponor Comfort Pipe PLUS Rohr					
 1062883	14x2,0 120m	1320	120	m	2,37
1062884	14x2,0 240m	1680	240	m	2,37
OUT 1088166	14x2,0 640m	1920	640	m	2,37
1062885	14x2,0 960m	1920	960	m	2,37
1034535	17x2,0 120m	840	120	m	2,49
1009226	17x2,0 240m	1200	240	m	2,49
1086340	17x2,0 480m	960	480	m	2,49
1009227	17x2,0 640m	1280	640	m	2,49

Art-Nr.	Dimension	LE	VE	ME	Preis/ME
Uponor Vario Klemmringverschraubung PEX					
 1065283	14x2,0-G ³ / ₄ "FT Euro	25	1	St.	5,84
1065286	17x2,0-G ³ / ₄ "FT Euro	25	1	St.	5,84
Uponor Fit Schraubkupplung PEX					
 1065299	17x2,0-17x2,0	25	1	St.	18,04
Uponor Fit Übergangverschraubung PEX					
 1065294	14x2,0-R ¹ / ₂ "MT	25	1	St.	14,65
1065300	17x2,0-R ¹ / ₂ "MT	25	1	St.	12,67
Uponor Fit Übergangverschraubung PEX					
 1065295	14x2,0-Rp ¹ / ₂ "FT	25	1	St.	15,28
Uponor Rapex Press-Kupplung					
 1005079	17-17	100	10	St.	11,57
Uponor Q&E Kupplung m. Ringen DR					
 1058659	14-14	100	10	St.	5,68
1058661	17-17	100	10	St.	8,40
Uponor Q&E Ring natural, eval					
 1058428	14	900	20	St.	0,35
Uponor Smart Presskupplung					
 1089646	14x2,0-14x2,0	80	20	St.	8,71
Uponor MLCP RED Rohr					
 1096010	14x1,6 240m	3120	240	m	1,36
1096011	14x1,6 480m	3360	480	m	1,36
1096012	16x2,0 240m	3120	240	m	1,48
1096013	16x2,0 480m	3360	480	m	1,48
Uponor Vario Eurokonusverschraubung MLCP RED					
 1000117	14x1,6- ³ / ₄ "Euro	80	20	St.	5,04
Uponor MLCP RED Press-Kupplung					
 1048272	14x1,6-14x1,6	80	20	St.	9,33
Uponor S-Press PLUS Kupplung					
 1070547	16-16	80	20	St.	8,60
Uponor S-Press PLUS Kupplung PPSU					
 1039933	16-16	80	20	St.	5,25
Uponor Uni-X Verschraubung MLC					
 1058090	16- ³ / ₄ "FT Euro	25	1	St.	6,66
Uponor Multi Rohrführungsbogen Kunststoff					
 1000118	18	250	50	St.	2,77

Uponor Nubos

Art-Nr.	Dimension	LE	VE	ME	Preis/ME
---------	-----------	----	----	----	----------



Uponor Nubos Noppenplatte

 1016699	EPS 30-2 14-16mm 1447x900x48mm	60	10	m ²	19,72
--	-----------------------------------	----	----	----------------	--------------

Uponor Nubos Noppenplatte

 1016700	EPS 11 14-16mm 1447x900x29mm	100	10	m ²	18,42
--	---------------------------------	-----	----	----------------	--------------

Uponor Nubos Noppenfolie

 1016703	14-16mm	140	10	m ²	10,89
1061880	14-16mm	-	200	m ²	10,37
 1084570	14-16mm	200	10	m ²	10,34

Uponor Nubos Noppen-Verteiler-/Tür Set

 1016701	EPS 30-2 14-16mm 1447x900x48mm	50	5	m ²	23,05
--	-----------------------------------	----	---	----------------	--------------

Uponor Nubos Noppen-Verteiler-/Tür Set

 1016702	EPS 11 14-16mm 1447x900x29mm	50	5	m ²	20,70
--	---------------------------------	----	---	----------------	--------------

Uponor Multi Randdämmstreifen mit Folie

 1000079	150x8mm	-	200	m	1,12
--	---------	---	-----	---	-------------

Hinweis:
Verkauf pro Verpackungseinheit.

Uponor Multi Randdämmstreifen Klebefolie

 1000080	150x10mm	-	200	m	2,28
--	----------	---	-----	---	-------------

Hinweis:
Verkauf pro Verpackungseinheit.

Uponor Multi Dehnungsfugenprofil

 1090229	1800x100x10mm	720	18	m	10,48
--	---------------	-----	----	---	--------------

Uponor Multi Schutzhülse



 1000082	20mm 300x5mm	1800	30	St.	1,01
--	--------------	------	----	-----	-------------

Uponor Fix Klemmschiene selbstklebend

 1000018	14-20mm c/c50mm 1m	600	100	m	4,94
--	--------------------	-----	-----	---	-------------

Art-Nr.	Dimension	LE	VE	ME	Preis/ME
---------	-----------	----	----	----	----------

Uponor Comfort Pipe PLUS Rohr

  1088166	14x2,0 640m	1920	640	m	2,37
--	-------------	------	-----	---	-------------

Uponor Comfort Pipe Rohr

 1047622	16x1,8 240m	1440	240	m	1,16
1047623	16x1,8 640m	1280	640	m	1,16

Uponor Vario Klemmringverschraubung PEX

 1065284	16x1,8/2,0-G¾"FT Euro	25	1	St.	5,84
--	-----------------------	----	---	-----	-------------

Uponor Smart Presskupplung

 1089647	16x1,8/2,0-16x1,8/2,0	80	20	St.	9,86
--	-----------------------	----	----	-----	-------------

Uponor MLCP RED Rohr

 1096010	14x1,6 240m	3120	240	m	1,36
1096011	14x1,6 480m	3360	480	m	1,36
1096012	16x2,0 240m	3120	240	m	1,48
1096013	16x2,0 480m	3360	480	m	1,48

Uponor Vario Eurokonusverschraubung MLCP RED

 1000117	14x1,6-¾" Euro	80	20	St.	5,04
--	----------------	----	----	-----	-------------

Uponor MLCP RED Press-Kupplung

 1048272	14x1,6-14x1,6	80	20	St.	9,33
--	---------------	----	----	-----	-------------

Uponor Uni-X Verschraubung MLC

 1058090	16-¾"FT Euro	25	1	St.	6,66
--	--------------	----	---	-----	-------------

Uponor S-Press PLUS Kupplung

 1070547	16-16	80	20	St.	8,60
--	-------	----	----	-----	-------------

Uponor S-Press PLUS Kupplung PPSU

 1039933	16-16	80	20	St.	5,25
--	-------	----	----	-----	-------------

Uponor Multi Rohrführungsbogen Kunststoff

 1000118	18	250	50	St.	2,77
--	----	-----	----	-----	-------------

 Lieferung solange Vorrat reicht.
Artikel läuft im Laufe des Jahres aus.

Uponor Klett

Art-Nr.	Dimension	LE	VE	ME	Preis/ME
 1063402	EPS DES 25-2mm 10x1m 80	10		m ²	10,01
1063322	EPS DES 30-2mm 10x1m 80	10		m ²	12,67
1063323	EPS DES 30-3mm 10x1m 80	10		m ²	11,16
1063324	EPS DES 35-3mm 10x1m 70	10		m ²	11,79

Uponor Klett Rollplatte

 1085788	G EPS DES WLS032 25-2mm 10x1m	80	10	m ²	11,11
--	----------------------------------	----	----	----------------	--------------

Uponor Klett Platte

 1007234	EPS DEO 15mm 2x1m	140	20	m ²	10,59
--	----------------------	-----	----	----------------	--------------

Uponor Klett Twinboard

 1086854	2400x1000x3mm	360	24	m ²	15,85
--	---------------	-----	----	----------------	--------------

Uponor Vario Heat Protect Verteilerplatte

 1090043	27mm	116	29	St.	43,91
--	------	-----	----	-----	--------------

Uponor Vario Heat Protect Rohrführungsplatte

 1090044	27mm	116	29	St.	39,42
--	------	-----	----	-----	--------------

Uponor Vario Heat Protect Verteilerplatte mit Trittschallschutz

 1091816	32mm	100	25	St.	62,37
--	------	-----	----	-----	--------------

Uponor Vario Heat Protect Rohrführungsplatte mit Trittschallschutz

 1091817	32mm	100	25	St.	52,25
--	------	-----	----	-----	--------------

Uponor Multi Randdämmstreifen mit Folie

 1000079	150x8mm	-	200	m	1,12
--	---------	---	-----	---	-------------

Hinweis:
Verkauf pro Verpackungseinheit.

Uponor Multi Randdämmstreifen Klebefolie

 1000080	150x10mm	-	200	m	2,28
--	----------	---	-----	---	-------------

Hinweis:
Verkauf pro Verpackungseinheit.

Uponor Multi Dehnungsfugenprofil

 1090229	1800x100x10mm	720	18	m	10,48
--	---------------	-----	----	---	--------------

Uponor Multi Schutzhülse

 1000082	20mm 300x5mm	1800	30	St.	1,01
--	--------------	------	----	-----	-------------

Art-Nr.	Dimension	LE	VE	ME	Preis/ME
---------	-----------	----	----	----	----------

Uponor Klett Panel Silent

 1088065	1200x1000x30mm	48	4,8	m ²	41,09
--	----------------	----	-----	----------------	--------------

Uponor Klett Randdämmstreifen

 1089919	1200X120X13mm	1536	96	m	4,62
--	---------------	------	----	---	-------------

Uponor Klett Abdichtstreifen

 1089951	50m 280x0,2mm	6000	50	m	5,20
--	---------------	------	----	---	-------------

Uponor Klett Klebeband spezial tape roll, special

 1007178	20m 50mm	30	5	St.	18,25
--	----------	----	---	-----	--------------

Uponor Multi Klebeband

 1000012	66m 50mm	36	1	St.	5,27
--	----------	----	---	-----	-------------

Uponor Multi Klebebandabroller

 1000142		20	1	St.	23,67
--	--	----	---	-----	--------------

Uponor Klett

Art-Nr.	Dimension	LE	VE	ME	Preis/ME
 1088479	14x2,0 240m	1440	240	m	1,79
1088480	14x2,0 640m	1280	640	m	1,79
1087302	16x2,0 240m	1200	240	m	1,87
1087303	16x2,0 640m	1280	640	m	1,87

Uponor Vario Klemmringverschraubung PEX

 1065283	14x2,0-G $\frac{3}{4}$ "FT Euro	25	1	St.	5,84
1065284	16x1,8/2,0-G $\frac{3}{4}$ "FT Euro	25	1	St.	5,84

Uponor Smart Presskupplung

 1089646	14x2,0-14x2,0	80	20	St.	8,71
1089647	16x1,8/2,0-16x1,8/2,0	80	20	St.	9,86

Uponor Fit Schraubkupplung PEX

 1065296	16x1,8/2,0-16x1,8/2,0	25	1	St.	18,98
--	-----------------------	----	---	-----	--------------

Uponor Fit Übergangverschraubung PEX

 1065294	14x2,0-R $\frac{1}{2}$ "MT	25	1	St.	14,65
1065297	16x1,8/2,0-R $\frac{1}{2}$ "MT	25	1	St.	15,44

Uponor Fit Übergangverschraubung PEX

 1065295	14x2,0-Rp $\frac{1}{2}$ "FT	25	1	St.	15,28
1065298	16x1,8/2,0-Rp $\frac{1}{2}$ "FT	25	1	St.	14,71

Uponor Q&E Kupplung m. Ringen DR

 1058659	14-14	100	10	St.	5,68
1058660	16x1,8/2,0-16x1,8/2,0	100	10	St.	7,09

Uponor Q&E Ring natural, eval

 1058428	14	900	20	St.	0,35
--	----	-----	----	-----	-------------

Uponor Q&E Sicherungsring white

 1057453	16	900	20	St.	0,35
--	----	-----	----	-----	-------------

Art-Nr.	Dimension	LE	VE	ME	Preis/ME
 1096014	16X2,0 240M	1920	240	m	1,85
1096015	16X2,0 480M	2400	480	m	1,85

Uponor Uni-X Verschraubung MLC

 1058090	16- $\frac{3}{4}$ "FT Euro	25	1	St.	6,66
--	----------------------------	----	---	-----	-------------

Uponor S-Press PLUS Kupplung

 1070547	16-16	80	20	St.	8,60
--	-------	----	----	-----	-------------

Uponor Multi Rohrführungsbogen Kunststoff

 1000118	18	250	50	St.	2,77
--	----	-----	----	-----	-------------

Uponor Multi Rohrhalterung

 1088066		-	1	St.	189,93
--	--	---	---	-----	---------------

Uponor Tacker

Art-Nr.	Dimension	LE	VE	ME	Preis/ME
---------	-----------	----	----	----	----------

Uponor Tacker Panel EPS DEO

 1090917	20	100	10	m ²	7,51	
1090918	30	80	10	m ²	9,59	
1090919	50mm	OUT	50	10	m ²	11,86

Uponor Tacker Rolle EPS DEO

 1090916	26mm 10x1m	80	10	m ²	8,08
--	------------	----	----	----------------	-------------

Uponor Tacker Rolle EPS DES

 1090921	20-2mm 10x1m	100	10	m ²	6,57	
1090922	25-2mm 10x1m	OUT	80	10	m ²	6,68

Uponor Tacker Rolle EPS DES

 1090924	30-2mm 10x1m	80	10	m ²	8,03
1090925	30-3mm 10x1m	80	10	m ²	7,09
1090926	35-3mm 10x1m	70	10	m ²	7,46
1090927	40-3mm 10x1m	60	10	m ²	9,54

Uponor Tacker Rolle G EPS DES WLS032

 1090923	25-2mm 10x1m	80	10	m ²	8,92
--	--------------	----	----	----------------	-------------

Uponor Tacker Folie

 1086527	0,2mm	2800	100	m ²	3,47
--	-------	------	-----	----------------	-------------

Uponor Multi Randdämmstreifen mit Folie

 1000079	150x8mm	-	200	m	1,12
--	---------	---	-----	---	-------------

*Hinweis:
Verkauf pro Verpackungseinheit.*

Uponor Multi Randdämmstreifen Klebefolie

 1000080	150x10mm	-	200	m	2,28
--	----------	---	-----	---	-------------

*Hinweis:
Verkauf pro Verpackungseinheit.*

Art-Nr.	Dimension	LE	VE	ME	Preis/ME
---------	-----------	----	----	----	----------

Uponor Multi Dehnungsfugenprofil

 1090229	1800x100x10mm	720	18	m	10,48
--	---------------	-----	----	---	--------------

Uponor Multi Schutzhülse

 1000082	20mm 300x5mm	1800	30	St.	1,01
--	--------------	------	----	-----	-------------

Uponor Multi Klebeband

 1000012	66m 50mm	36	1	St.	5,27
--	----------	----	---	-----	-------------

Uponor Multi Klebebandabroller

 1000142		20	1	St.	23,67
--	--	----	---	-----	--------------

Uponor Comfort Pipe Rohr

 1047622	16x1,8 240m	1440	240	m	1,16
1047623	16x1,8 640m	1280	640	m	1,16

Uponor Vario Klemmringverschraubung PEX

 1065284	16x1,8/2,0-G $\frac{3}{4}$ "FT Euro	25	1	St.	5,84
---	-------------------------------------	----	---	-----	-------------

Uponor Fit Schraubkupplung PEX

 1065296	16x1,8/2,0-16x1,8/2,0	25	1	St.	18,98
--	-----------------------	----	---	-----	--------------

Uponor Smart Presskupplung

 1089647	16x1,8/2,0-16x1,8/2,0	80	20	St.	9,86
--	-----------------------	----	----	-----	-------------

Uponor MLCP RED Rohr

 1096010	14x1,6 240m	3120	240	m	1,36
1096011	14x1,6 480m	3360	480	m	1,36
1096012	16x2,0 240m	3120	240	m	1,48
1096013	16x2,0 480m	3360	480	m	1,48

Uponor Tacker

Art-Nr.	Dimension	LE	VE	ME	Preis/ME
---------	-----------	----	----	----	----------

Uponor Vario Eurokonusverschraubung MLCP RED

 1000117	14x1,6-3/4" Euro	80	20	St.	5,04
--	------------------	----	----	-----	-------------

Uponor Uni-X Verschraubung MLC

 1058090	16-3/4" FT Euro	25	1	St.	6,66
--	-----------------	----	---	-----	-------------

Uponor MLCP RED Press-Kupplung

 1048272	14x1,6-14x1,6	80	20	St.	9,33
--	---------------	----	----	-----	-------------

Uponor S-Press PLUS Kupplung

 1070547	16-16	80	20	St.	8,60
--	-------	----	----	-----	-------------

Uponor S-Press PLUS Kupplung PPSU

 1039933	16-16	80	20	St.	5,25
--	-------	----	----	-----	-------------

Uponor Tacker Nadel kurz

 1086528	14-20mm h=35mm	6000	300	St.	0,13
--	----------------	------	-----	-----	-------------

Uponor Tacker Nadel

 1086529	14-20mm h=40mm	75000	1000	St.	0,05
--	----------------	-------	------	-----	-------------

Uponor Tacker Nadel

 1086530	14-20mm h=55mm	4800	300	St.	0,26
--	----------------	------	-----	-----	-------------

Art-Nr.	Dimension	LE	VE	ME	Preis/ME
---------	-----------	----	----	----	----------

Uponor Tacker Tackergerät

 OUT 1002295	14-20mm l=700mm	32	1	St.	285,42
---	-----------------	----	---	-----	---------------

Uponor Tacker-Werkzeug

 NEU 1119039	14-20mm	50	1	St.	210,00
---	---------	----	---	-----	---------------

Uponor Multi Rohrführungsbogen Kunststoff

 1000118	18	250	50	St.	2,77
1001229	20	2300	50	St.	3,41

OUT Lieferung solange Vorrat reicht.
Artikel läuft im Laufe des Jahres aus.

Uponor Classic

Art-Nr.	Dimension	LE	VE	ME	Preis/ME
---------	-----------	----	----	----	----------

Uponor Classic Stahlmatte beschichtet

 1005085	50mm 2150x750x3mm	450	15	m ²	19,82
1005084	100mm 2100x1200x3mm	750	25	m ²	9,02
1005087	150mm 2100x1200x3mm	750	25	m ²	7,51

Uponor Classic Stahlmatte

 1063406	100mm 2100x1200x3mm	750	25	m ²	7,14
1063407	150mm 2100x1200x3mm	750	25	m ²	5,10

Uponor Classic Mattenbinder

 1007393	80mm (100pce/set)	2500	50	Set	3,77
--	-------------------	------	----	-----	-------------

Uponor Classic Rohralter

 1005189	17mm 3mm	500	500	St.	0,30
1005190	20mm 3mm	2800	280	St.	0,44

Hinweis:

Verkauf von pro Verpackungseinheit.

Uponor Classic Rohralter

 OUT 1005047	17mm 3mm	108000	500	St.	0,30
--	----------	--------	-----	-----	-------------

Hinweis:

Verkauf von pro Verpackungseinheit.

Uponor Multi Randdämmstreifen mit Folie

 1000079	150x8mm	-	200	m	1,12
--	---------	---	-----	---	-------------

Hinweis:

Verkauf pro Verpackungseinheit.

Uponor Multi Randdämmstreifen Klebefolie

 1000080	150x10mm	-	200	m	2,28
--	----------	---	-----	---	-------------

Hinweis:

Verkauf pro Verpackungseinheit.

Uponor Multi Dehnungsfugenprofil

 1090229	1800x100x10mm	720	18	m	10,48
--	---------------	-----	----	---	--------------

Uponor Multi Schutzhülse

 1000082	20mm 300x5mm	1800	30	St.	1,01
--	--------------	------	----	-----	-------------

Art-Nr.	Dimension	LE	VE	ME	Preis/ME
---------	-----------	----	----	----	----------

Uponor Comfort Pipe PLUS Rohr

 1034535	17x2,0 120m	840	120	m	2,49
1009226	17x2,0 240m	1200	240	m	2,49
1086340	17x2,0 480m	960	480	m	2,49
1009227	17x2,0 640m	1280	640	m	2,49

Uponor Magna pipe PLUS

 1091275	20x2,0 240m	960	240	m	2,49
1091276	20x2,0 480m	960	480	m	2,49

Uponor Vario Klemmringverschraubung PEX

 1065286	17x2,0-G $\frac{3}{4}$ "FT Euro	25	1	St.	5,84
1065290	20x1,9/2,0-G $\frac{3}{4}$ "FT Euro	25	1	St.	6,10

Uponor Fit Schraubkupplung PEX

 1065299	17x2,0-17x2,0	25	1	St.	18,04
1065302	20x1,9/2,0-20x1,9/2,0	25	1	St.	29,20

Uponor Smart Presskupplung

 1089648	20x2,0-20x2,0	80	20	St.	11,00
--	---------------	----	----	-----	--------------

Uponor Fit Übergangverschraubung PEX

 1065300	17x2,0-R $\frac{1}{2}$ "MT	25	1	St.	12,67
1065305	20x1,9/2,0-R $\frac{3}{4}$ "MT	25	1	St.	19,19

Uponor Fit Übergangverschraubung PEX

 1065306	20x1,9/2,0-Rp $\frac{3}{4}$ "FT	25	1	St.	19,87
--	---------------------------------	----	---	-----	--------------

Uponor Rapex Press-Kupplung

 1005079	17-17	100	10	St.	11,57
--	-------	-----	----	-----	--------------

Uponor Q&E Kupplung m. Ringen DR

 1058661	17-17	100	10	St.	8,40
1058668	20-20	80	10	St.	8,40

Uponor Multi Rohrführungsbogen Kunststoff

 1000118	18	250	50	St.	2,77
1001229	20	2300	50	St.	3,41

Uponor Classic Clipmaster

 1006295	16/17mm l=920mm	100	1	St.	148,42
1006309	20mm l=920mm	-	1	St.	255,34

Uponor Classic Drillgerät f. Mattenbinder

 1006243	l=320mm	50	1	St.	20,03
--	---------	----	---	-----	--------------

OUT Lieferung solange Vorrat reicht.
Artikel läuft im Laufe des Jahres aus.

Uponor Siccus 14

Art-Nr.	Dimension	LE	VE	ME	Preis/ME
---------	-----------	----	----	----	----------

Uponor Siccus 14 Verlegeplatte

 1005485	EPS 150kPa 14mm 1197x1050x25mm	100	12,5 m ²		15,54
--	-----------------------------------	-----	---------------------	--	--------------



Uponor Multi Randdämmstreifen mit Folie

 1000079	150x8mm	-	200 m		1,12
<i>Hinweis: Verkauf pro Verpackungseinheit.</i>					

Uponor Siccus 14 Wärmeleitlamelle

 1005486	14mm 1180x120x0,45mm	768	48 St.		5,47
--	----------------------	-----	--------	--	-------------

Uponor Comfort Pipe PLUS Rohr

 1062883	14x2,0 120m	1320	120 m		2,37
1062884	14x2,0 240m	1680	240 m		2,37
 1088166	14x2,0 640m	1920	640 m		2,37
1062885	14x2,0 960m	1920	960 m		2,37

Uponor Vario Klemmringverschraubung PEX

 1065283	14x2,0-G ³ / ₄ "FT Euro	25	1 St.		5,84
---	---	----	-------	--	-------------

Uponor Fit Übergangverschraubung PEX

 1065294	14x2,0-R ¹ / ₂ "MT	25	1 St.		14,65
--	--	----	-------	--	--------------

Uponor Fit Übergangverschraubung PEX

 1065295	14x2,0-Rp ¹ / ₂ "FT	25	1 St.		15,28
--	---	----	-------	--	--------------

Uponor Q&E Kupplung m. Ringen DR

 1058659	14-14	100	10 St.		5,68
--	-------	-----	--------	--	-------------

Uponor Q&E Ring natural, eval

 1058428	14	900	20 St.		0,35
--	----	-----	--------	--	-------------

Uponor Smart Presskupplung

 1089646	14x2,0-14x2,0	80	20 St.		8,71
--	---------------	----	--------	--	-------------

Art-Nr.	Dimension	LE	VE	ME	Preis/ME
---------	-----------	----	----	----	----------

Uponor MLCP RED Rohr

 1096010	14x1,6 240m	3120	240 m		1,36
1096011	14x1,6 480m	3360	480 m		1,36

Uponor Vario Eurokonusverschraubung MLCP RED

 1000117	14x1,6- ³ / ₄ "Euro	80	20 St.		5,04
--	---	----	--------	--	-------------

Uponor MLCP RED Press-Kupplung

 1048272	14x1,6-14x1,6	80	20 St.		9,33
--	---------------	----	--------	--	-------------

Uponor Multi Rohrführungsbogen Kunststoff

 1000118	18	250	50 St.		2,77
--	----	-----	--------	--	-------------

Uponor Siccus Sport Stahlblechabdeckung

 1085611	26m ² 0,6X1000X2000mm	-	26 m ²		20,29
1085610	204m ² 0,6x1000x2000mm	-	204 m ²		18,30

Uponor Siccus 14 Schneidegerät

 1006290	14mm 230V	20	1 St.		208,63
---	-----------	----	-------	--	---------------

Uponor Siccus 14 Schneideinsatz

 1006291	14	-	1 St.		185,61
--	----	---	-------	--	---------------

Uponor Comfort E

Art-Nr.	Dimension	LE	VE	ME	Preis/ME
---------	-----------	----	----	----	----------

Uponor Comfort E Kabelmatte set T-87IF

 1088668	160-1	50	1	Set	277,43
1088669	160-1,5	50	1	Set	324,34
1088670	160-2	50	1	Set	341,05
1088671	160-2,5	50	1	Set	387,96
1088672	160-3	50	1	Set	399,43
1088673	160-4	35	1	Set	450,57
1088674	160-5	35	1	Set	497,48
1088675	160-6	35	1	Set	552,62
1088676	160-7	20	1	Set	599,53
1088677	160-8	20	1	Set	630,96
1088678	160-10	20	1	Set	683,10
1088679	160-12	20	1	Set	787,39

Uponor Comfort E Kabelmatte

 1088656	160-1	50	1	Set	112,63
1088657	160-1,5	50	1	Set	152,25
1088658	160-2	50	1	Set	174,18
1088659	160-2,5	50	1	Set	230,50
1088660	160-3	50	1	Set	241,96
1088661	160-4	35	1	Set	314,97
1088662	160-5	35	1	Set	370,85
1088663	160-6	35	1	Set	439,07
1088664	160-7	20	1	Set	505,70
1088665	160-8	20	1	Set	561,88
1088666	160-10	20	1	Set	618,07
1088667	160-12	20	1	Set	735,11

Uponor Comfort E AL-Folie Rollmatte set T-87IF

 1088694	140-1	50	1	Set	277,43
1088695	140-2	50	1	Set	335,81
1088696	140-3	50	1	Set	399,43
1088697	140-4	35	1	Set	463,05
1088698	140-5	35	1	Set	526,67
1088699	140-6	50	1	Set	589,29
1088700	140-7	35	1	Set	662,15
1088701	140-8	35	1	Set	730,01
1088702	140-9	35	1	Set	709,05
1088703	140-10	35	1	Set	771,67

Art-Nr.	Dimension	LE	VE	ME	Preis/ME
---------	-----------	----	----	----	----------

Uponor Comfort E AL-Folie Rollmatte

 1088684	140-1	50	1	Set	152,25
1088685	140-2	50	1	Set	213,80
1088686	140-3	50	1	Set	281,58
1088687	140-4	35	1	Set	359,83
1088688	140-5	50	1	Set	427,04
1088689	140-6	50	1	Set	505,85
1088690	140-7	35	1	Set	584,36
1088691	140-8	35	1	Set	667,33
1088692	140-9	35	1	Set	696,74
1088693	140-10	35	1	Set	719,65

Uponor Comfort E AL-Folie Isolierung

 1088707	5mm	200	5	m ²	10,43
--	-----	-----	---	----------------	--------------

Uponor Comfort E Analoges Thermostat set T-85

 1088705	230V	-	1	Set	106,76
--	------	---	---	-----	---------------

Uponor Comfort E Unterputzthermostat - digital programmierbar - flush Set T-87IF

 1088706	230V	-	1	Set	213,82
--	------	---	---	-----	---------------

Uponor Comfort E Kabel R-Set

 1090942	230V	20	1	Set	19,71
--	------	----	---	-----	--------------

Uponor Comfort E Schutzrohr

 1090943		100	1	St.	16,89
--	--	-----	---	-----	--------------

Uponor Comfort E Bodenfühler T-85, T-87

 1090944		100	1	St.	23,62
--	--	-----	---	-----	--------------

Uponor Renovis

Art-Nr.	Dimension	LE	VE	ME	Preis/ME
---------	-----------	----	----	----	----------

Uponor Renovis Panel

 1061173	800x625mm	-	24	St.	81,04
1061172	1200x625mm	-	24	St.	109,49
1061171	2000x625mm	-	24	St.	123,06

Uponor Renovis Panel extra

 1063923	800x625x15mm	24	1	St.	90,32
1063924	1200x625x15mm	24	1	St.	113,68
1063925	2000x625x15mm	24	1	St.	136,63

Uponor Renovis Panel

 1063926	2000x625x15mm	-	24	St.	31,29
--	---------------	---	----	-----	--------------

Uponor Renovis Anschlusset

 1061165	4-6X	10	1	Set	439,08
--	------	----	---	-----	---------------

Uponor Fix Klemmschiene

 1005274	9,9mm c/c20mm 2,5m	25	2,5	m	5,02
---	--------------------	----	-----	---	-------------

Uponor Renovis Klemmschiene

 1061162	20mm l=250mm	-	15	St.	4,46
--	--------------	---	----	-----	-------------

Uponor Minitec Rohr Comfort Pipe

 1063287	9,9x1,1 60m	840	60	m	2,88
1063288	9,9x1,1 120m	1680	120	m	2,88

Uponor Minitec Übergangsnippel

 1005265	9,9-R $\frac{1}{2}$ MT	100	10	St.	9,60
--	------------------------	-----	----	-----	-------------

Uponor Minitec Ring

 1005263	9,9x1,1	1600	10	St.	0,35
--	---------	------	----	-----	-------------

Art-Nr.	Dimension	LE	VE	ME	Preis/ME
---------	-----------	----	----	----	----------

Uponor Minitec Kupplung

 1005264	9,9x1,1	100	10	St.	7,82
--	---------	-----	----	-----	-------------

Uponor Comfort Pipe PLUS Rohr

 1009229	20x2,0	660	60	m	2,52
--	--------	-----	----	---	-------------

Uponor Magna pipe PLUS

 1091275	20x2,0	960	240	m	2,49
1091276	20x2,0	960	480	m	2,49

Uponor Minitec T-Stück reduziert Q&E

 1020524	20xMinitec9,9xQ&E20	75	5	St.	11,99
--	---------------------	----	---	-----	--------------

Uponor Minitec Kupplung red. Q&E

 1020518	20xMinitec9,9	150	5	St.	13,45
--	---------------	-----	---	-----	--------------

Uponor Q&E Kupplung PPSU

 1008932	20-20	80	5	St.	4,53
--	-------	----	---	-----	-------------

Uponor Q&E Kupplung m. Ringen CE PPSU

 1072005	20-20	30	1	St.	5,50
--	-------	----	---	-----	-------------

Uponor Q&E Winkel PPSU

 1008680	20-20	40	5	St.	5,81
--	-------	----	---	-----	-------------

Uponor Q&E Sicherungsring white

 1057454	20	520	20	St.	0,47
--	----	-----	----	-----	-------------

Uponor Renovis

Art-Nr.	Dimension	LE	VE	ME	Preis/ME
---------	-----------	----	----	----	----------

Uponor Uni Pipe PLUS weiß S

 1060784	20x2,25 3m	51	3	m	7,46
--	------------	----	---	---	-------------

Uponor Q&E T-Stück Übergang S-Press

 1063938	20-Q&E9,9-Press20	6	2	St.	11,94
--	-------------------	---	---	-----	--------------

Uponor Q&E Übergang S-Press

 1063939	20-Q&E9,9	12	2	St.	9,55
--	-----------	----	---	-----	-------------

Uponor Vario VL-Feinregulierventil

 1005107	1/2" - G3/4	50	1	St.	25,97
--	-------------	----	---	-----	--------------

Passende Verschraubungen finden Sie im Kapitel Verteiler und Zubehör

Uponor Vario RL-Ventil

 1005108	1/2" - G3/4	50	1	St.	25,29
---	-------------	----	---	-----	--------------

Uponor Vario PLUS Thermoantrieb PRO 230V 1W NC

 OUT 1090263	VA02 MT 30x1,5	100	1	St.	63,62
---	----------------	-----	---	-----	--------------

Uponor Base Raumfühler T-23

 1058422	230V RAL9010	160	1	St.	42,45
--	--------------	-----	---	-----	--------------

Art-Nr.	Dimension	LE	VE	ME	Preis/ME
---------	-----------	----	----	----	----------

Uponor Minitec Aufweitwerkzeug

 1006247	9,9x1,1	11	1	Set	298,91
--	---------	----	---	-----	---------------

Uponor Q&E Aufweitwerkzeug mit Aufweitk. M12

 1063112	6BAR 9,9/20	-	1	Set	505,48
--	-------------	---	---	-----	---------------

Uponor Q&E Aufweitkopf M12/M18

 1057173	20x1,9/2,0	-	1	St.	113,13
--	------------	---	---	-----	---------------

Uponor Q&E Aufweitkopf M12

 1060702	9,9x1,1	-	1	St.	113,13
--	---------	---	---	-----	---------------

Uponor Multi Umlenkbogen, Kunststoff

 1063781	12	500	50	St.	1,04
---	----	-----	----	-----	-------------

OUT Lieferung solange Vorrat reicht.
Artikel läuft im Laufe des Jahres aus.

Uponor Siccus wall

Art-Nr.	Dimension	LE	VE	ME	Preis/ME
---------	-----------	----	----	----	----------

Uponor Siccus 14 Verlegeplatte

	1005485 EPS 150kPa 14mm 1197x1050x25mm	100	12,5 m ²		15,54
---	--	-----	---------------------	--	--------------

Uponor Siccus 14 Wärmeleitlamelle

	1005486 14mm 1180x120x0,45mm	768	48 St.		5,47
---	-------------------------------------	-----	--------	--	-------------

Uponor Comfort Pipe PLUS Rohr

	1062883 14x2,0 120m	1320	120 m		2,37
	1062884 14x2,0 240m	1680	240 m		2,37
	1062885 14x2,0 960m	1920	960 m		2,37

Uponor Vario Klemmringverschraubung PEX

	1065283 14x2,0-G ³ / ₄ "FT Euro	25	1 St.		5,84
---	--	----	-------	--	-------------

Uponor Fit Übergangverschraubung PEX

	1065294 14x2,0-R ¹ / ₂ "MT	25	1 St.		14,65
---	---	----	-------	--	--------------

Uponor Fit Übergangverschraubung PEX

	1065295 14x2,0-Rp ¹ / ₂ "FT	25	1 St.		15,28
--	--	----	-------	--	--------------

Uponor Q&E Kupplung m. Ringen DR

	1058659 14-14	100	10 St.		5,68
---	----------------------	-----	--------	--	-------------

Uponor Q&E Ring natural, eval

	1058428 14	900	20 St.		0,35
---	-------------------	-----	--------	--	-------------

Uponor Smart Presskupplung

	1089646 14x2,0-14x2,0	80	20 St.		8,71
---	------------------------------	----	--------	--	-------------

Uponor MLCP RED Rohr

	1096010 14x1,6 240m	3120	240 m		1,36
	1096011 14x1,6 480m	3360	480 m		1,36

Uponor Vario Eurokonusverschraubung MLCP RED

	1000117 14x1,6- ³ / ₄ "Euro	80	20 St.		5,04
---	--	----	--------	--	-------------

Uponor MLCP RED Press-Kupplung

	1048272 14x1,6-14x1,6	80	20 St.		9,33
---	------------------------------	----	--------	--	-------------

Uponor Siccus 14 Schneidegerät

	1006290 14mm 230V	20	1 St.		208,63
---	--------------------------	----	-------	--	---------------

Uponor Siccus SW

Art-Nr.	Dimension	LE	VE	ME	Preis/ME
---------	-----------	----	----	----	----------

Uponor Siccus SW Ständerwandelement

	1005499 14mm 1150x615mm	56,6	1,2 m ²		115,76
---	--------------------------------	------	--------------------	--	---------------

Uponor Comfort Pipe PLUS Rohr

	1062883 14x2,0 120m	1320	120 m		2,37
	1062884 14x2,0 240m	1680	240 m		2,37

Uponor Vario Klemmringverschraubung PEX

	1065283 14x2,0-G ³ / ₄ "FT Euro	25	1 St.		5,84
---	--	----	-------	--	-------------

Uponor Fit Übergangverschraubung PEX

	1065294 14x2,0-R ¹ / ₂ "MT	25	1 St.		14,65
---	---	----	-------	--	--------------

Uponor Fit Übergangverschraubung PEX

	1065295 14x2,0-Rp ¹ / ₂ "FT	25	1 St.		15,28
---	--	----	-------	--	--------------

Uponor Q&E Kupplung m. Ringen DR

	1058659 14-14	100	10 St.		5,68
--	----------------------	-----	--------	--	-------------

Uponor Q&E Ring natural, eval

	1058428 14	900	20 St.		0,35
---	-------------------	-----	--------	--	-------------

Uponor Fix 14

Art-Nr.	Dimension	LE	VE	ME	Preis/ME
---------	-----------	----	----	----	----------

Uponor Fix Klemmschiene

 1005498	14mm c/c50mm 2,5m	-	25	m	4,25
--	-------------------	---	----	---	-------------

Uponor Comfort Pipe PLUS Rohr

 1062883	14x2,0 120m	1320	120	m	2,37
1062884	14x2,0 240m	1680	240	m	2,37
1062885	14x2,0 960m	1920	960	m	2,37

Uponor Vario Klemmringverschraubung PEX

 1065283	14x2,0-G $\frac{3}{4}$ "FT Euro	25	1	St.	5,84
--	---------------------------------	----	---	-----	-------------

Uponor Fit Übergangverschraubung PEX

 1065294	14x2,0-R $\frac{1}{2}$ "MT	25	1	St.	14,65
--	----------------------------	----	---	-----	--------------

Uponor Fit Übergangverschraubung PEX

 1065295	14x2,0-Rp $\frac{1}{2}$ "FT	25	1	St.	15,28
--	-----------------------------	----	---	-----	--------------

Uponor Q&E Kupplung m. Ringen DR

 1058659	14-14	100	10	St.	5,68
--	-------	-----	----	-----	-------------

Uponor Q&E Ring natural, eval

 1058428	14	900	20	St.	0,35
--	----	-----	----	-----	-------------

Uponor Smart Presskupplung

 1089646	14x2,0-14x2,0	80	20	St.	8,71
--	---------------	----	----	-----	-------------

Art-Nr.	Dimension	LE	VE	ME	Preis/ME
---------	-----------	----	----	----	----------

Uponor MLCP RED Rohr

 1096010	14x1,6 240m	3120	240	m	1,36
1096011	14x1,6 480m	3360	480	m	1,36

Uponor Vario Eurokonusverschraubung MLCP RED

 1000117	14x1,6- $\frac{3}{4}$ "Euro	80	20	St.	5,04
--	-----------------------------	----	----	-----	-------------

Uponor MLCP RED Press-Kupplung

 1048272	14x1,6-14x1,6	80	20	St.	9,33
--	---------------	----	----	-----	-------------

Uponor Fix 9,9

Art-Nr.	Dimension	LE	VE	ME	Preis/ME
---------	-----------	----	----	----	----------

Uponor Fix Klemmschiene

 1005274	9,9mm c/c20mm 2,5m	25	2,5	m	5,02
--	--------------------	----	-----	---	-------------

Uponor Multi Umlenkbogen, Kunststoff

 1063781	12	500	50	St.	1,04
--	----	-----	----	-----	-------------

Uponor Minitec Rohr Comfort Pipe

 1063287	9,9x1,1	840	60	m	2,88
1063288	9,9x1,1	1680	120	m	2,88
1063381	9,9x1,1	2880	480	m	2,88

Uponor Minitec Ring

 1005263	9,9x1,1	1600	10	St.	0,35
--	---------	------	----	-----	-------------

Uponor Vario Eurokonusverschraubung Minitec

 1005266	9,9x1,1-G $\frac{3}{4}$ "Euro	100	10	St.	9,02
--	-------------------------------	-----	----	-----	-------------

Uponor Minitec Kupplung

 1005264	9,9x1,1	100	10	St.	7,82
---	---------	-----	----	-----	-------------

Uponor Minitec T-Stück reduziert Q&E

 1020524	20x9,9x20	75	5	St.	11,99
--	-----------	----	---	-----	--------------

Uponor Minitec Übergangsnippel

 1005265	9,9-R $\frac{1}{2}$ "MT	100	10	St.	9,60
--	-------------------------	-----	----	-----	-------------

Uponor Comfort Pipe PLUS Rohr

 1009229	20x2,0	660	60	m	2,52
1009228	20x2,0	840	120	m	2,52

Art-Nr.	Dimension	LE	VE	ME	Preis/ME
---------	-----------	----	----	----	----------

Uponor Minitec Kupplung red. Q&E

 1020518	20x9,9	150	5	St.	13,45
--	--------	-----	---	-----	--------------

Uponor Q&E Sicherungsring white

 1057454	20	520	20	St.	0,47
--	----	-----	----	-----	-------------

Uponor Vario Klemmringverschraubung PEX

 1065290	20x1,9/2,0-G $\frac{3}{4}$ "FT Euro	25	1	St.	6,10
--	-------------------------------------	----	---	-----	-------------

Uponor Minitec Aufweitwerkzeug

 1006247	9,9x1,1	11	1	Set	298,91
--	---------	----	---	-----	---------------

Uponor Q&E Aufweitwerkzeug mit Aufweitk. M12

 1063112	9,9/20	-	1	Set	505,48
--	--------	---	---	-----	---------------

Uponor Q&E Aufweitkopf M12/M18

 1057173	20x1,9/2,0	-	1	St.	113,13
--	------------	---	---	-----	---------------

Uponor Q&E Aufweitkopf M12

 1060702	9,9x1,1	-	1	St.	113,13
--	---------	---	---	-----	---------------

Uponor Thermanop

Art-Nr.	Dimension	LE	VE	ME	Preis/ME
---------	-----------	----	----	----	----------

Uponor Thermanop M



1090933	950x277mm	200	10	St.	49,64
1090934	1350x277mm	200	10	St.	69,77
1090935	1750x277mm	200	10	St.	89,90
1090936	2150x277mm	200	10	St.	112,60
1090937	2550x277mm	200	10	St.	132,43

Verbindungstechnik: die einzelnen Module können mit der üblichen Uponor-Verbindungstechnologie S-Press oder RTM verbunden werden

Art-Nr.	Dimension	LE	VE	ME	Preis/ME
---------	-----------	----	----	----	----------

Uponor Uni-X Verschraubung MLC



1058090	16-3/4"FT Euro	25	1	St.	
----------------	----------------	----	---	-----	--

Uponor S-Press PLUS Kupplung



1070547	16-16	80	10	St.	
----------------	-------	----	----	-----	--

Uponor S-Press PLUS Kupplung PPSU



1039933	16-16	80	10	St.	
----------------	-------	----	----	-----	--



Uponor Multi Zubehör Fußbodenaufbau

Flächenheizung und -kühlung

Zubehör Fußbodenaufbau

Art-Nr.	Dimension	LE	VE	ME	Preis/ME
---------	-----------	----	----	----	----------

Uponor Multi Rohrbinder PA

 1005372	200mm	5000	100	St.	0,21
<i>Hinweis: Verkauf von pro Verpackungseinheit.</i>					

Uponor Multi Rohrbinder PA

 1086531	200mm	10000	100	St.	0,14
--	-------	-------	-----	-----	-------------

Uponor Multi Klemmschiene

 1005358	20mm c/c50mm 3m	30	3	m	6,99
--	-----------------	----	---	---	-------------

Uponor Multi Dampfsperre PE

 1005069	3/300 3,3mm 40x1,25m	250	50	m ²	8,85
<i>Hinweis: Verkauf von pro Verpackungseinheit.</i>					

Uponor Multi Klebeband

 1005071	15m	8	1	St.	57,47
--	-----	---	---	-----	--------------

Uponor Multi Folie PE

 1005051	0,1mm 75x2m	6900	150	m ²	1,02
<i>Hinweis: Verkauf von pro Verpackungseinheit.</i>					

Uponor Multi Folie PE

 1005049	0,2mm 60x1,25m	3375	75	m ²	1,56
<i>Hinweis: Verkauf von pro Verpackungseinheit.</i>					

Uponor Multi Folie

 1000017	4mm 60x1m	-	60	m ²	7,72
--	-----------	---	----	----------------	-------------

Uponor Multi Rasterfolie

 1000015	0,25mm 100x1,03m	2472	103	m ²	3,01
--	------------------	------	-----	----------------	-------------

Uponor Multi Foliendübel

 1000016	l=25mm	5000	100	St.	0,29
<i>Hinweis: Verkauf von pro Verpackungseinheit.</i>					

Uponor Multi Randdämmstreifen mit Folie

 1000079	150x8mm	-	200	m	1,12
<i>Hinweis: Verkauf pro Verpackungseinheit.</i>					

Uponor Multi Randdämmstreifen Klebefolie

 1000080	150x10mm	-	200	m	2,28
<i>Hinweis: Verkauf pro Verpackungseinheit.</i>					

Art-Nr.	Dimension	LE	VE	ME	Preis/ME
---------	-----------	----	----	----	----------

Uponor Multi Dehnungsfugenprofil

 1090229	1800x100x10mm	720	18	m	10,48
--	---------------	-----	----	---	--------------

Uponor Multi Klebeband

 1000012	66m 50mm	36	1	St.	5,27
--	----------	----	---	-----	-------------

Uponor Multi Schutzhülse

 1000082	20mm 300x5mm	1800	30	St.	1,01
--	--------------	------	----	-----	-------------

Uponor Multi Estrichkomponente VD 450

 1000084	20L	480	20	l	5,10
<i>Hinweis: Vor Frost und UV schützen. Rücknahme ausgeschlossen.</i>					

Uponor Multi Estrichkomponente VD 550

 1000085	25L	600	25	l	10,01
<i>Hinweis: Vor Frost und UV schützen. Rücknahme ausgeschlossen.</i>					

Uponor Multi Messstellenmarkierung

 1000083	100mm	-	10	St.	5,84
--	-------	---	----	-----	-------------

Uponor Multi Gebundene Schüttung

 1000052	100l	2500	100	l	1,15
<i>Hinweis: Verkauf von pro Verpackungseinheit.</i>					

Uponor Multi Frostschutzmittel

 1005066	≥ -30°C 20l	480	20	l	16,90
<i>Hinweis: Vor Frost und UV schützen. Rücknahme ausgeschlossen.</i>					

Verteil und Steigleitungen >20mm

Art-Nr.	Dimension	LE	VE	ME	Preis/ME
---------	-----------	----	----	----	----------

Uponor Uni Pipe PLUS weiß S

 1060785	25x2,5 3m	33	3	m	10,90
1060786	32x3,0 3m	21	3	m	14,51

Uponor MLC Rohr weiß S

 1013448	40x4,0 3m	12	3	m	29,03
1021980	50x4,5 3m	12	3	m	41,17
1021981	63x6,0 3m	9	3	m	52,22
1013453	75x7,5 5m	255	5	m	82,49

Uponor S-Press PLUS Kupplung PPSU

 1039935	25-25	80	10	St.	10,63
1039936	32-32	80	10	St.	15,61

Uponor S-Press Verbund Kupplung PPSU

 1046401	40-40	960	5	St.	28,18
1046402	50-50	576	3	St.	36,72
1032881	63-63	384	1	St.	73,65
1032882	75-75	384	1	St.	121,31

Uponor S-Press PLUS Kupplung reduziert PPSU

 1039940	32-25	80	10	St.	15,97
1039941	40-25	960	5	St.	28,18
1039942	40-32	960	5	St.	28,18
1039943	50-32	1152	3	St.	36,72

Uponor S-Press Verbund Kupplung red. PPSU

 1046406	50-40	576	3	St.	36,72
1032883	63-40	384	1	St.	69,62
1032884	63-50	384	1	St.	71,10
1032885	75-50	384	1	St.	102,30
1032886	75-63	384	1	St.	113,15

Uponor S-Press PLUS Winkel PPSU

 1039931	25-25	80	10	St.	15,31
1039932	32-32	20	5	St.	21,07

Uponor S-Press Verbund Winkel PPSU

 1046386	40-40	960	5	St.	40,28
1046387	50-50	576	3	St.	50,29
1032877	63-63	210	1	St.	98,14
1032878	75-75	210	1	St.	157,99

Uponor S-Press Verbund Winkel 45° PPSU

 1046388	40-40	960	5	St.	40,79
1046389	50-50	576	3	St.	52,84
1032879	63-63	192	1	St.	102,30
1032880	75-75	192	1	St.	147,29

Art-Nr.	Dimension	LE	VE	ME	Preis/ME
---------	-----------	----	----	----	----------

Uponor S-Press PLUS T-Stück PPSU

 1039946	25-25-25	20	5	St.	17,40
1039947	32-32-32	20	5	St.	28,57

Uponor S-Press Verbund T-Stück PPSU

 1046390	40-40-40	720	5	St.	55,50
1046391	50-50-50	288	3	St.	69,50
1032887	63-63-63	150	1	St.	130,82
1032888	75-75-75	150	1	St.	206,18

Uponor S-Press PLUS T-Stück m. Innengew.

 1070598	25-Rp $\frac{1}{2}$ "FT-25	20	5	St.	32,72
1070600	32-Rp $\frac{1}{2}$ "FT-32	20	5	St.	46,88

Uponor S-Press T-Stück mit Innengewinde

 1046922	40-Rp $\frac{1}{2}$ "FT-40	500	5	St.	54,54
1046929	50-Rp1"FT-50	240	3	St.	90,71

Uponor S-Press PLUS Übergangsnippel

 1070507	25-R $\frac{3}{4}$ "MT	80	10	St.	16,88
1070508	25-R1"MT	40	5	St.	19,95
1070509	32-R1"MT	40	5	St.	21,96
1070510	32-R1 $\frac{1}{4}$ "MT	20	5	St.	28,46

Uponor S-Press Übergangsnippel

 1046901	40-R1 $\frac{1}{4}$ "MT	960	5	St.	35,56
1046902	40-R1 $\frac{1}{2}$ "MT	960	5	St.	39,33
1046905	50-R1 $\frac{1}{2}$ "MT	1152	3	St.	59,00
1046906	50-R2"MT	576	3	St.	75,82
1032895	63-R2"MT	336	1	St.	107,65
1032896	75-R2 $\frac{1}{2}$ "MT	336	1	St.	141,91

Uponor S-Press PLUS Übergangsmuffe

 1070519	25-Rp $\frac{3}{4}$ "FT	40	5	St.	19,64
1070520	25-Rp1"FT	40	5	St.	20,67
1070521	32-Rp1"FT	40	5	St.	24,03
1070522	32-Rp1 $\frac{1}{4}$ "FT	20	5	St.	29,66

Uponor S-Press Übergangsmuffe

 1046903	40-Rp1 $\frac{1}{4}$ "FT	960	5	St.	37,00
1046904	40-Rp1 $\frac{1}{2}$ "FT	960	5	St.	37,39
1046907	50-Rp1 $\frac{1}{2}$ "FT	1152	3	St.	90,16

Uponor Vario PLUS

Art-Nr.	Dimension	LE	VE	ME	Preis/ME
---------	-----------	----	----	----	----------

Uponor Vario PLUS Verteiler mit Ventil

 1042420	LS 1X ¾ Euro	10	1	Paar	57,36
1030580	LS 3X ¾ Euro	290	1	Paar	139,72
1030581	LS 4X ¾ Euro	225	1	Paar	175,22
1030582	LS 6X ¾ Euro	155	1	Paar	248,23

Uponor Vario PLUS Verteiler m. Durchflm.

 1042471	FM 1X ¾ Euro	10	1	Paar	70,82
1030583	FM 3X ¾ Euro	174	1	Paar	161,63
1030584	FM 4X ¾ Euro	135	1	Paar	210,67
1030585	FM 6X ¾ Euro	93	1	Paar	305,57

Uponor Vario Klemmringverschraubung PEX

 1065283	14x2,0-G¾"FT Euro	25	1	St.	5,84
1065284	16x1,8/2,0-G¾"FT Euro	25	1	St.	5,84
1065286	17x2,0-G¾"FT Euro	25	1	St.	5,84
1065290	20x1,9/2,0-G¾"FT Euro	25	1	St.	6,10

Uponor Vario PLUS Verteiler Basis Set

 1009209	K1	248	1	St.	110,52
---	----	-----	---	-----	---------------

Uponor Vario PLUS Thermoantrieb NC

 1000138	24V MT30x1,5	10	1	St.	61,00
1005605	230V MT30x1,5	10	1	St.	61,00

Uponor Vario PLUS Dämmset

 1063207		-	1	Set	92,51
--	--	---	---	-----	--------------

Uponor Vario PLUS Winkelset

 1032702	122/42	5	1	Paar	26,60
--	--------	---	---	------	--------------

Uponor Vario PLUS Verteileranschlusset

 1005227		10	1	Set	57,78
--	--	----	---	-----	--------------

Uponor Vario PLUS Distanzringset

 1009215		10	1	St.	9,70
--	--	----	---	-----	-------------

Art-Nr.	Dimension	LE	VE	ME	Preis/ME
---------	-----------	----	----	----	----------

Uponor Vario PLUS Schlauchtülle

 1009214	G¾ x ½	10	1	St.	2,64
--	--------	----	---	-----	-------------

Uponor Vario PLUS Durchflussmesser

 1009217	4 l/min	20	1	St.	15,28
--	---------	----	---	-----	--------------

Uponor Vario PLUS Thermoantrieb PRO 24V 1W NC

 1090262	VA02 MT 30x1,5	100	1	St.	63,62
--	----------------	-----	---	-----	--------------

Uponor Vario PLUS Thermoantrieb PRO 230V 1W NC

 1090263	VA02 MT 30x1,5	100	1	St.	63,62
--	----------------	-----	---	-----	--------------

Uponor Vario PLUS Stellantrieb 100 kOhm

 1005544	24V NC MT30x1,5 0-10V DC	100	1	St.	157,46
--	-----------------------------	-----	---	-----	---------------

Uponor Vario PLUS Endsegmentset

 1005226		10	1	Set	31,18
---	--	----	---	-----	--------------

Uponor Vario PLUS Vorlauf-Ventileinsatz scale 1-5

 1034523		20	20	St.	14,29
--	--	----	----	-----	--------------

Uponor Vario PLUS Rücklaufventileinsatz

 1005250		10	1	St.	12,62
--	--	----	---	-----	--------------

Uponor Vario PLUS Thermometer 0-60°C





 1034524	D=40mm	20	1	Paar	19,23
--	--------	----	---	------	--------------

Uponor Vario PLUS Wandhalterset

 1046883	225-35-50	10	1	Set	15,80
--	-----------	----	---	-----	--------------

Uponor Vario M

Art-Nr.	Dimension	LE	VE	ME	Preis/ME
 1085944	2X G¾ Euro	80	1	St.	169,97
1085945	3X G¾ Euro	80	1	St.	219,02
1085946	4X G¾ Euro	80	1	St.	269,08
1085947	5X G¾ Euro	80	1	St.	319,13
1085948	6X G¾ Euro	80	1	St.	362,93
1085949	7X G¾ Euro	80	1	St.	410,92
1085950	8X G¾ Euro	80	1	St.	460,96
1085951	9X G¾ Euro	80	1	St.	508,96
1085952	10X G¾ Euro	80	1	St.	563,03
1086250	11X G¾ Euro	108	1	St.	625,60
1086251	12X G¾ Euro	108	1	St.	672,72
1087129	13X G¾ Euro	30	1	St.	808,24
1087130	14X G¾ Euro	30	1	St.	849,87
1087131	15X G¾ Euro	30	1	St.	886,49

Art-Nr.	Dimension	LE	VE	ME	Preis/ME
Uponor Vario M Halterung					
 1087531		-	1	Set	19,09
Uponor Vario M Durchflussanzeige					
 1085956	0-5l/min	-	1	St.	11,42
Uponor Vario M Rücklaufventil					
 1085957		-	1	St.	9,60
Uponor Vario M Thermometer					
 1085958		-	1	Set	13,09
Uponor Vario M Sicherheitsbügel Set					
 1085959	3x2	-	1	Set	6,59

 Lieferung solange Vorrat reicht.
Artikel läuft im Laufe des Jahres aus.

Uponor Vario S Edelstahlverteiler

Flächenheizung und -kühlung

Verteiltertechnik

Art-Nr.	Dimension	LE	VE	ME	Preis/ME
---------	-----------	----	----	----	----------

Uponor Vario S-Verteiler FM

 1086538 2X $\frac{3}{4}$ Euro	108	1	St.	128,28
1086539 3x $\frac{3}{4}$ Euro	108	1	St.	165,82
1086540 4x $\frac{3}{4}$ Euro	108	1	St.	204,41
1086541 5x $\frac{3}{4}$ Euro	108	1	St.	240,91
1086542 6x $\frac{3}{4}$ Euro	72	1	St.	278,46
1086543 7X $\frac{3}{4}$ Euro	72	1	St.	314,96
1086544 8x $\frac{3}{4}$ Euro	72	1	St.	353,55
1086545 9x $\frac{3}{4}$ Euro	72	1	St.	392,15
1086546 10x $\frac{3}{4}$ Euro	48	1	St.	430,74
1086547 11x $\frac{3}{4}$ Euro	48	1	St.	469,33
1086548 12x $\frac{3}{4}$ Euro	48	1	St.	507,92
1088864 13x $\frac{3}{4}$ Euro	48	1	St.	557,97
1088865 14X $\frac{3}{4}$ Euro	36	1	St.	599,56
1088866 15x $\frac{3}{4}$ Euro	36	1	St.	641,38
1088867 16x $\frac{3}{4}$ Euro	36	1	St.	677,74

Uponor Vario S Verteiler LS

 1088045 2X $\frac{3}{4}$ Euro	108	1	St.	119,91
1088046 3X $\frac{3}{4}$ Euro	108	1	St.	149,14
1088047 4X $\frac{3}{4}$ Euro	108	1	St.	171,05
1088048 5X $\frac{3}{4}$ Euro	108	1	St.	193,96
1088049 6X $\frac{3}{4}$ Euro	72	1	St.	221,10
1088050 7X $\frac{3}{4}$ Euro	72	1	St.	245,10
1088051 8X $\frac{3}{4}$ Euro	72	1	St.	271,14
1088052 9X $\frac{3}{4}$ Euro	72	1	St.	296,19
1088053 10X $\frac{3}{4}$ Euro	48	1	St.	326,42
1088054 11X $\frac{3}{4}$ Euro	48	1	St.	351,46
1088055 12x $\frac{3}{4}$ Euro	48	1	St.	375,46
1088868 13x $\frac{3}{4}$ Euro	48	1	St.	491,24
1088869 14x $\frac{3}{4}$ Euro	36	1	St.	526,60
1088870 15X $\frac{3}{4}$ Euro	36	1	St.	568,42
1088871 16X $\frac{3}{4}$ Euro	36	1	St.	662,19

Uponor Vario S Thermoantrieb Edelstahl. NC

 NEU 1013008 24V NC FT30x1,5	10	1	St.	32,50
NEU 1013006 230V NC FT30x1,5	10	1	St.	32,50

Uponor Vario S Verteiler Kappenventil LS

 OUT 1088056	-	10	St.	6,62
---	---	----	-----	-------------

Art-Nr.	Dimension	LE	VE	ME	Preis/ME
---------	-----------	----	----	----	----------

Uponor Vario S-Thermometer

 1086537		10	1	Set	25,81
--	--	----	---	-----	--------------

Uponor Vario Kugelhahn

 1086558 $\frac{3}{4}$ -G1		10	1	Set	26,70
--	--	----	---	-----	--------------

Uponor Vario Eck-Kugelhahn

 1086559 Rp $\frac{3}{4}$ " - G1"		-	1	Set	59,45
---	--	---	---	-----	--------------

Uponor Vario S Verteiler Durchflussmesser

 1087608		-	10	St.	15,59
--	--	---	----	-----	--------------

Uponor Vario Thermoantrieb S

 OUT 1087763 230V		100	1	Set	33,69
--	--	-----	---	-----	--------------

Uponor Vario Thermoantrieb S

 OUT 1087778 24V		100	1	Set	33,69
---	--	-----	---	-----	--------------

OUT Lieferung solange Vorrat reicht. Artikel läuft im Laufe des Jahres aus.

Uponor Vario Zubehör Verteilertechnik

Art-Nr.	Dimension	LE	VE	ME	Preis/ME
---------	-----------	----	----	----	----------

Uponor Vario Bezeichnungsschilder

 1005063	47x10mm	-	1	Set	28,78
--	---------	---	---	-----	--------------

Uponor Vario Regulierventil

 1005100	G1 - Rp1	10	1	Set	75,66
--	----------	----	---	-----	--------------

Uponor Vario Vorlaufventileinsatz

 1005098		-	1	St.	27,30
--	--	---	---	-----	--------------

Uponor Vario Rücklauf-Ventileinsatz

 1005099		10	1	St.	27,74
--	--	----	---	-----	--------------

Uponor Vario Vorlaufventil-Handrad, weiß

 OUT 1005101		-	1	St.	2,27
---	--	---	---	-----	-------------

Uponor Vario Rücklaufventil-Handrad, schwarz

 OUT 1005102		-	1	St.	2,27
---	--	---	---	-----	-------------

Uponor Vario Kugelhahn

 1059132	NP G1-G1	10	1	Set	29,79
--	----------	----	---	-----	--------------

Uponor Vario Kugelhahn

 1086558	¾-G1	10	1	Set	26,70
--	------	----	---	-----	--------------

Uponor Vario Eck-Kugelhahn

 1086559	Rp ¾" - G1"	-	1	Set	59,45
--	-------------	---	---	-----	--------------

 1090732	G1-Rp1	260	1	Set	51,59
--	--------	-----	---	-----	--------------

Uponor Vario WMZ-Anschlussset horizontal

 1090730	G¾" 110mm	250	1	Set	114,15
--	-----------	-----	---	-----	---------------

 1090728	G1" 130mm	-	1	Set	178,50
--	-----------	---	---	-----	---------------

Uponor Vario WMZ-Anschlussset vertikal

 1090731	G¾" 110mm	250	1	Set	167,09
--	-----------	-----	---	-----	---------------

 1090729	G1" 130mm	250	1	Set	185,71
--	-----------	-----	---	-----	---------------

OUT Lieferung solange Vorrat reicht.
Artikel läuft im Laufe des Jahres aus.

Art-Nr.	Dimension	LE	VE	ME	Preis/ME
---------	-----------	----	----	----	----------

Uponor Aqua PLUS Verteilerkappe m. Dichtung

 1001337	¾"FT	250	10	St.	4,86
--	------	-----	----	-----	-------------

Uponor Vario VL-Feinregulierventil

 1005107	½" - G¾"	50	1	St.	25,97
--	----------	----	---	-----	--------------

Passende Verschraubungen finden Sie im Kapitel Verteiler und Zubehör

Uponor Vario RL-Ventil

 1005108	½" - G¾"	50	1	St.	25,29
--	----------	----	---	-----	--------------

Uponor Viva Differenzdruckregler

 1085820	Rp1 - G1	120	1	St.	656,90
--	----------	-----	---	-----	---------------

Uponor Vario Verteilerschränke

Flächenheizung und -kühlung

Verteilerertechnik

Art-Nr.	Dimension	LE	VE	ME	Preis/ME
---------	-----------	----	----	----	----------

Uponor Vario Verteilerschrank IW

 1093491	550x730x110mm	27	1	St.	81,25
1093492	700x730x110mm	16	1	St.	90,95
1093493	850x730x110mm	18	1	St.	108,46
1093494	1000x730x110mm	13	1	St.	119,91
1093495	1150x730x110mm	9	1	St.	130,36
1093496	1300x730x110mm	9	1	St.	140,80

Uponor Vario Verteilerschrank IW

 1093497	550x730x80mm	27	1	St.	78,01
1093498	700x730x80mm	25	1	St.	87,72
1093499	850x730x80mm	19	1	St.	105,33
1093500	1000x730x80mm	15	1	St.	116,78
1093501	1150x730x80mm	12	1	St.	125,13
1093502	1300x730x80mm	9	1	St.	135,58

Uponor Vario Schrank Rahmen/Tür IW S

 1093528	550x730mm	75	1	St.	92,09
1093541	700x730mm	55	1	St.	113,69
1093542	850x730mm	50	1	St.	128,27
1093543	1000x730mm	40	1	St.	151,20
1093544	1150x730mm	25	1	St.	174,14
1093546	1300x730mm	22	1	St.	201,26

Uponor Vario Schrank Rahmen/Tür IW P

 1093547	550x730mm	75	1	St.	119,91
1093548	700x730mm	55	1	St.	140,80
1093549	850x730mm	50	1	St.	155,38
1093550	1000x730mm	40	1	St.	178,32
1093551	1150x730mm	25	1	St.	201,26
1093552	1300x730mm	22	1	St.	227,37

Uponor Vario Halterungsset

 1093522	(5pcs)	200	1	St.	9,23
---	--------	-----	---	-----	------

Uponor Vario Zylinderschloss 2 Schlüssel

 1093554		200	1	St.	42,24
---	--	-----	---	-----	-------

Uponor Vario Schiene

 1093555		200	1	St.	9,75
---	--	-----	---	-----	------

Uponor Vario Schrank-Zylinderschloss UP

 1030101		-	100	St.	47,46
---	--	---	-----	-----	-------

Hinweis: Für die Verteilerschränke UP / AP 3+4 sind jeweils 2 Schlösser vorzusehen.

Art-Nr.	Dimension	LE	VE	ME	Preis/ME
---------	-----------	----	----	----	----------

Uponor Vario Tür für Verteilerschrank UP1

 1046556	OUT	-	1	St.	97,41
1046557	OUT	10	1	St.	110,53
1046558	OUT	-	1	St.	147,02

Uponor Vario Rahmen für Verteilerschrank UP1

 1046560	OUT	-	1	St.	118,63
1046561	OUT	-	1	St.	125,92
1046562	OUT	-	1	St.	143,92

Uponor Vario Verteilerschrank Aufputz AP

 1045478	600x156mm	11	1	St.	180,41
1045479	800x156mm	10	1	St.	202,34
1045480	1000x156mm	9	1	St.	242,99
1045481	1350x156mm	8	1	St.	293,04

Uponor Vario Schrankrückwand AP

 1045482	580mm	15	1	St.	102,94
1045483	780mm	30	1	St.	123,07
1045484	980mm	20	1	St.	135,59
1045485	1330mm	-	1	St.	179,37

Uponor Magna Verteilerschrank Aufputz

 1060553	1010x835x200mm	-	1	St.	283,68
1060554	1910x835x200mm	-	1	St.	378,59
1060555	2310x835x200mm	-	1	St.	431,80

Uponor Vario Handrad m.Einstellungsanz.Ring COMP

 1005104		100	10	St.	3,14
---	--	-----	----	-----	------

Uponor Vario Durchflussmesser mit Schauglas rot A

 1013004		20	1	St.	18,77
---	--	----	---	-----	-------

Uponor Vario Ventileinsatz

 1013021		50	1	St.	12,25
---	--	----	---	-----	-------

Uponor Vario Rücklaufventileinsatz für KPV COMP

 1046632		10	1	Set	107,35
---	--	----	---	-----	--------

Uponor Vario Anschlussstück

 1058573	G1-G1A	30	1	St.	20,34
---	--------	----	---	-----	-------

Verteilerschränke Einbaumaße

Bestückungsoptionen und Einbaumaße für Uponor Verteiler Vario PLUS, Vario M und Vario S

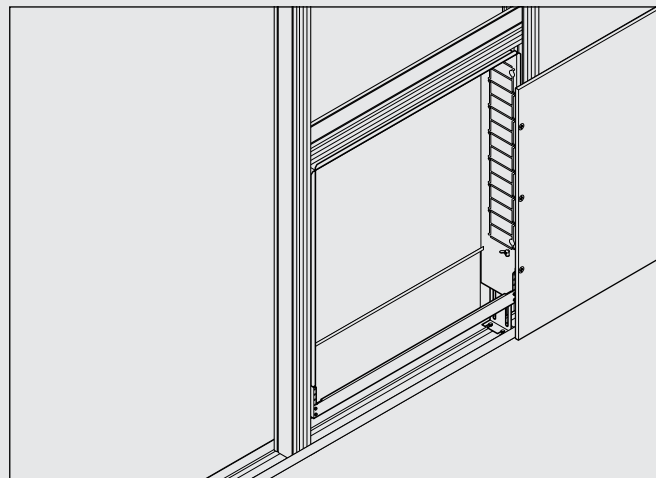
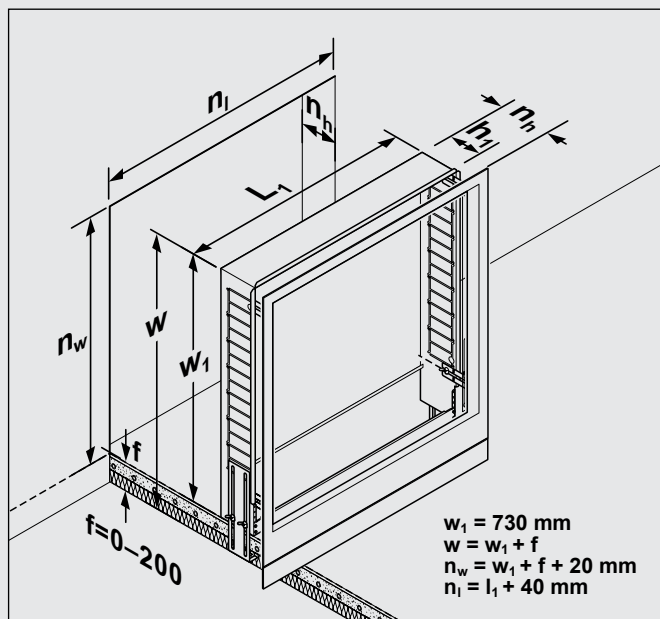

mit Uponor Vario PLUS Verteiler	Variante	Anschlusssituation	Verteilerschrank Breite l_1 (mm)						h_1 (mm)	n_h min. (mm)
			550	700	850	1000	1150	1300		
geeignet für Anzahl Heizkreise										
	1	Vertikal (ohne Vario WMZ-Anschlusset)	2-4	5-7	8-10	11-13	14-15	-	80	80*
	2	Vertikal (mit Vario WMZ-Anschlusset)	2-4	5-7	8-10	11-13	14-15	-	80	95
	3	Seitlich (ohne Vario WMZ-Anschlusset)	2-5	6-8	9-11	12-14	15	-	80	80*
	4	Seitlich (mit Vario WMZ-Anschlusset)	-	2-3	4-6	7-9	10-12	13-15	80	95
	5	Mit Pumpengruppe Push 23 B	2-3	4-6	7-9	10-12	13-15	-	110	110*
	6	Mit Pumpengruppe MPG 10 / Push 23 A	-	2-4	5-7	8-10	11-13	14-15	110	110*
	7	Seitlich mit Viva Diff.-druckregler und WMZ	-	2	3-5	6-8	9-11	12-14	80	80*
	8	Vertikal mit Viva Diff.-druckregler und WMZ	-	2-3	4-6	7-9	10-12	13-15	80	95

mit Uponor Vario M Verteiler	Variante	Anschlusssituation	Verteilerschrank Breite l_1 (mm)						h_1 (mm)	n_h min. (mm)
			550	700	850	1000	1150	1300		
geeignet für Anzahl Heizkreise										
	1	Vertikal (ohne Vario WMZ-Anschlusset)	2-5	6-8	9-10	11-13	14-15	-	80	80*
	2	Vertikal (mit Vario WMZ-Anschlusset)	2-5	6-8	9-10	11-13	14-15	-	80	95
	3	Seitlich (ohne Vario WMZ-Anschlusset)	2-6	7-9	10-11	12-14	15	-	80	80*
	4	Seitlich (mit Vario WMZ-Anschlusset)	-	2-4	5-7	8-10	11-12	13-15	80	95
	5	Mit Pumpengruppe Push 23 B	2-4	5-7	8-10	11-12	13-15	-	110	110*
	6	Mit Pumpengruppe MPG 10 / Push 23 A	-	2-4	5-7	8-10	11-13	14-15	110	110*
	7	Seitlich mit Viva Diff.-druckregler und WMZ	-	2-3	4-6	7-9	10-11	12-14	80	80*
	8	Vertikal mit Viva Diff.-druckregler und WMZ	-	2-4	5-7	8-10	11-12	13-15	80	95

mit Uponor Vario S Verteiler	Variante	Anschlusssituation	Verteilerschrank Breite l_1 (mm)						h_1 (mm)	n_h min. (mm)
			550	700	850	1000	1150	1300		
geeignet für Anzahl Heizkreise										
	1	Vertikal (ohne Vario WMZ-Anschlusset)	2-5	6-8	9-11	12-14	15-16	-	80	80*
	2	Vertikal (mit Vario WMZ-Anschlusset)	2-5	6-8	9-11	12-14	15-16	-	80	95
	3	Seitlich (ohne Vario WMZ-Anschlusset)	2-6	7-9	10-12	13-15	16	-	80	80*
	4	Seitlich (mit Vario WMZ-Anschlusset)	-	2-4	5-7	8-10	11-13	14-16	80	95
	5	Mit Pumpengruppe Push 23 B	2-4	5-7	8-10	11-13	14-16	-	110	110*
	6	Mit Pumpengruppe MPG 10 / Push 23 A	-	2-4	5-7	8-10	11-13	14-16	110	110*
	7	Seitlich mit Viva Diff.-druckregler und WMZ	-	2-3	4-6	7-9	10-12	13-15	80	80*
	8	Vertikal mit Viva Diff.-druckregler und WMZ	-	2-4	5-7	8-10	11-13	14-16	80	95

* plus 10 mm bei Einsatz der Kunststofftür

Uponor Smatrix

Systemfinder Uponor Einzelraumregelungen für Flächenheizung/-kühlung im Wohnungsbau





Heizen und Kühlen		Nur Heizen		
mit Auto-Abgleich		mit Auto-Abgleich	ohne Auto-Abgleich	
Funk	verdrahtet	Funk	verdrahtet	verdrahtet
Uponor Smatrix Wave PULSE	Uponor Smatrix Base PULSE	Uponor Smatrix Wave PULSE	Uponor Smatrix Base PULSE	Uponor Base mit Flexiboard

Einzelraumregelungen Wohnungsbau

Die Uponor Regelung	... ist eine:
Uponor Smatrix Wave PULSE	per App gesteuerte Funk-Einzelraumregelung zum Heizen und Kühlen mit vielen Features, z.B. Anbindung an Smart Home (Alexa) und Cloud
Uponor Smatrix Wave	Funk-Raumtemperaturregelung für die Flächenheizung und -kühlung
Uponor Smatrix Base PULSE	per App gesteuerte kabelgebundene Einzelraumregelung zum Heizen und Kühlen mit vielen Features, z.B. Anbindung an Smart Home (Alexa) und Cloud
Uponor Smatrix Base	Kabelgebundene 24 V-Raumtemperaturregelung für Flächenheizungen
Uponor Smatrix Base PRO	Kabelgebundene Einzelraumregelung zum Heizen und Kühlen mit bis zu 16 Regelmodulen für den Gewerbebau und für große Objekte
Uponor Base	konventionelle verdrahtete 230 V Einzelraumregelung zur einfachen Raumtemperaturregelung
Uponor Space	einfach zu bedienende Raumtemperaturregelung für Kühldecken mit Taupunktüberwachung
Uponor Smatrix Style	Design-Raumfühler mit Feuchteüberwachung für Smatrix Wave/Base PULSE und Smatrix Base PRO Einzelraumregelung
Smatrix Move	witterungsgeführter Vorlauftemperaturregler zum Heizen und Kühlen
Smatrix Move PRO	witterungsgeführter Mehrzonen-Vorlauftemperaturregler für den Gewerbebau zum Heizen oder Heizen/Kühlen und zusätzlich mit Schnee- und Eisfreihaltung

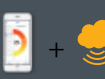
Uponor Smatrix

Funktionsumfang Smatrix Wave/Base

Uponor Smatrix Regelungstechnik	Komplettversion		ohne Cloud		nur Regelmodul	
	 Smatrix Wave PULSE	 Smatrix Base PULSE	 Smatrix Wave PULSE	 Smatrix Base PULSE	 Smatrix Wave PULSE	 Smatrix Base PULSE
Fernzugriff	■	■				
Komforteinstellung	■	■				
Absenprogramme	■	■				
Updates per App	■	■				
Einbindung Alexa	■	■				
Fernschaltung weiterer Anlagenkomponenten per Relaismodul	■					
Lokaler Zugriff über WLAN	■	■	■	■		
Max./Min.-Begrenzung der Sollwerttemperatur	■	■	■	■		
Einrichten einer Regelungsgruppe aus 4 Regelmodulen	■	■	■	■		
Erweiterte Heizen/ Kühlen-Umschalt- möglichkeiten	■	■	■	■		
Zentraler Absenkmodus	■	■	■	■		
Auto-Abgleich	■	■	■	■	■	■
Heizen und Kühlen	■	■	■	■	■	■
RF Schalterleiste		■		■		■
Regelung von Heizkörpern	■	■	■	■	■	■

Uponor Smatrix Wave Pulse

Flächenheizung und -kühlung

Regelungstechnik

Art-Nr.	Dimension	LE	VE	ME	Preis/ME
---------	-----------	----	----	----	----------

Uponor Smatrix Wave Starter-Set Pulse S

 1093284		3	1	Set	1303,56
--	--	---	---	-----	----------------

Uponor Smatrix Wave Starter-Set Pulse L

 1093287		2	1	Set	2012,57
--	--	---	---	-----	----------------

Uponor Smatrix Schnittstelle Pulse com R-208

 1093030		16	1	St.	508,98
--	--	----	---	-----	---------------

Uponor Smatrix Wave Regelmodul Pulse X-265

 1093021		4	1	St.	401,51
--	--	---	---	-----	---------------

Uponor Smatrix Wave Slave-Modul Pulse M-262

 1093133		16	1	St.	102,94
--	--	----	---	-----	---------------

Uponor Smatrix Wave Raumtemperatur-Feuchtfühler Style T-169

 1087816 weiß		180	1	St.	179,37
 1087817 schwarz		180	1	St.	179,37

Uponor Smatrix Wave Raumtemperatur-Feuchtfühler Style T-161

 1087815		180	1	St.	166,87
--	--	-----	---	-----	---------------

Uponor Smatrix Wave Raumfühler prog.+RH T-168

 1086984 RAL9016		75	1	St.	160,59
--	--	----	---	-----	---------------

Uponor Smatrix Wave Raumfühler digit. T-166

 1086982 RAL9016		75	1	St.	141,82
--	--	----	---	-----	---------------

Art-Nr.	Dimension	LE	VE	ME	Preis/ME
---------	-----------	----	----	----	----------

Uponor Smatrix Wave PLUS Raumfühler D+RH T-167 grey

 1071674		75	1	St.	141,82
--	--	----	---	-----	---------------

Uponor Smatrix Wave Raumfühler T-165 POD

 1086981 RAL9016		75	1	St.	116,81
--	--	----	---	-----	---------------

Uponor Smatrix Wave Raumfühler BM T-163

 1086979 RAL9016		75	1	St.	154,33
--	--	----	---	-----	---------------

Uponor Smatrix Wave Thermostatkopf T-162

 1071660		24	1	St.	98,35
--	--	----	---	-----	--------------

Uponor Smatrix Wandrahmen T-X A-1XX

 1086986 RAL9016		250	1	St.	6,78
--	--	-----	---	-----	-------------

Uponor Smatrix Boden- oder Fernfühler S-1XX

 1071684		63	1	St.	35,67
--	--	----	---	-----	--------------

Uponor Smatrix Schaltmodul H/K M-1XX

 1083576 24V		84	1	St.	135,57
--	--	----	---	-----	---------------

Uponor Smatrix Schaltmodul H/K M-1XX

 1083577 230V		16	1	St.	147,03
---	--	----	---	-----	---------------

Uponor Smatrix Wave Antenne Pulse A-265

 1093028		16	1	St.	216,93
--	--	----	---	-----	---------------

Uponor Smatrix Wave

Art-Nr.	Dimension	LE	VE	ME	Preis/ME
---------	-----------	----	----	----	----------

Uponor Smatrix Wave Bedienmodul I-167



 1071646		7	1	St.	379,65
--	--	---	---	-----	---------------

Uponor Smatrix Wave Regelmodul X-165



 1071685 6X		4	1	St.	478,70
---	--	---	---	-----	---------------

Uponor Smatrix Wave Erweiterungsmodul M-160



 1071659 6X		16	1	St.	72,59
---	--	----	---	-----	--------------

Uponor Smatrix Wave Funk Schaltmodul M-161



1071673 2X		16	1	St.	122,01
-------------------	--	----	---	-----	---------------

Uponor Smatrix Wave Antenne A-165



1071667		50	1	St.	165,84
----------------	--	----	---	-----	---------------

Art-Nr.	Dimension	LE	VE	ME	Preis/ME
---------	-----------	----	----	----	----------

Uponor Smatrix Thermoantrieb Retrofit A-XXX



1083575 24V, NC, 1W		100	1	Set	51,63
----------------------------	--	-----	---	-----	--------------

Uponor Vario PLUS Thermoantrieb PRO 24V 1W NC



 1090262 VA02 MT 30x1,5		100	1	St.	63,62
---	--	-----	---	-----	--------------

Uponor Vario B Thermoantrieb PRO 24V 1W NC



 1090264 VA32 FT 28x1,5		100	1	St.	63,62
---	--	-----	---	-----	--------------

 Lieferung solange Vorrat reicht.
Artikel läuft im Laufe des Jahres aus.

Uponor Smatrix Base Pulse

Flächenheizung und -kühlung

Regelungstechnik

Art-Nr.	Dimension	LE	VE	ME	Preis/ME
---------	-----------	----	----	----	----------

Uponor Smatrix Base Starter-Set Pulse S

 1093280		3	1	Set	1136,87
--	--	---	---	-----	----------------

Uponor Smatrix Base Starter-Set Pulse L

 1093282		2	1	Set	1679,18
--	--	---	---	-----	----------------

Uponor Smatrix Schnittstelle Pulse com R-208

 1093030		16	1	St.	508,98
--	--	----	---	-----	---------------

Uponor Smatrix Base Regelmodul Pulse X-245 BUS

 1093017		4	1	St.	271,16
--	--	---	---	-----	---------------

Uponor Smatrix Base Slave-Modul Pulse M-242 BUS

 1093134		16	1	St.	92,09
--	--	----	---	-----	--------------

Uponor Smatrix Base Stern-Modul Pulse M-243 BUS

 1093135		16	1	St.	70,40
--	--	----	---	-----	--------------

Uponor Smatrix Base Raumtemperatur-Feuchtefühler Style T-149 Bus

 1087813 weiß		180	1	St.	166,87
 1087814 schwarz		180	1	St.	166,87

Uponor Smatrix Base Schaltuhr I-143 Bus

 1086978 RAL9016		75	1	St.	134,52
--	--	----	---	-----	---------------

Uponor Smatrix Base Raumfühler prog.+RH T-148 Bus

 1086977 RAL9016		75	1	St.	105,31
--	--	----	---	-----	---------------

Art-Nr.	Dimension	LE	VE	ME	Preis/ME
---------	-----------	----	----	----	----------

Uponor Smatrix Base Raumfühler digit. T-146 Bus

 1086976 RAL9016		75	1	St.	97,10
--	--	----	---	-----	--------------

Uponor Smatrix Base Raumthermostat T-145 Bus POD

 1086975 RAL9016		75	1	St.	47,97
--	--	----	---	-----	--------------

Uponor Smatrix Base Raumfühler UP T-144 Bus

 1086973 RAL9016		60	1	St.	76,24
--	--	----	---	-----	--------------

Uponor Smatrix Base Raumfühler BM T-143 Bus

 1086972 RAL9016		75	1	St.	66,33
--	--	----	---	-----	--------------

Uponor Smatrix Base Aufputz-Wandrahmen Style T-149 A-14X

 1087821		90	1	St.	7,14
--	--	----	---	-----	-------------

Uponor Smatrix Base Aufputz-Wandrahmen Style T-149 A-14X

 1087822 BLACK		90	1	St.	7,14
--	--	----	---	-----	-------------

Uponor Smatrix Wandrahmen T-X A-1XX

 1086986 RAL9016		250	1	St.	6,78
--	--	-----	---	-----	-------------

Uponor Smatrix Base Bus-Kabel A-145

 1071670 50m		2	1	St.	127,22
--	--	---	---	-----	---------------

Uponor Smatrix Boden- oder Fernfühler S-1XX

 1071684		63	1	St.	35,67
--	--	----	---	-----	--------------

Uponor Smatrix Schaltmodul H/K M-1XX

 1083576 24V		84	1	St.	135,57
--	--	----	---	-----	---------------

Uponor Smatrix Base

Art-Nr.	Dimension	LE	VE	ME	Preis/ME
---------	-----------	----	----	----	----------

Uponor Smatrix Base Regelmodul X-145 Bus

 OUT 1071690	6X	4	1	St.	208,56
--	----	---	---	-----	--------

Uponor Smatrix Base Erweiterungsmodul M-140 Bus

 1071686	6X	16	1	St.	72,59
---	----	----	---	-----	-------

Uponor Smatrix Base Stern Modul M-141 Bus

 1071651	8X	16	1	St.	84,80
---	----	----	---	-----	-------

Art-Nr.	Dimension	LE	VE	ME	Preis/ME
---------	-----------	----	----	----	----------

Uponor Vario Thermoantrieb S

 OUT 1087778	24V	100	1	Set	33,69
--	-----	-----	---	-----	-------

Uponor Smatrix Thermoantrieb Retrofit A-XXX

 1083575	24V, NC, 1W	100	1	Set	51,63
---	-------------	-----	---	-----	-------

Uponor Vario PLUS Thermoantrieb PRO 24V 1W NC

 OUT 1090262	VA02 MT 30x1,5	100	1	St.	63,62
--	----------------	-----	---	-----	-------

Uponor Vario B Thermoantrieb PRO 24V 1W NC

 OUT 1090264	VA32 FT 28x1,5	100	1	St.	63,62
--	----------------	-----	---	-----	-------

Uponor Smatrix Schaltmodul H/K M-1XX

 1083577	230V	16	1	St.	147,03
---	------	----	---	-----	--------

Uponor Smatrix Base PRO

Art-Nr.	Dimension	LE	VE	ME	Preis/ME
---------	-----------	----	----	----	----------

Uponor Smatrix Base PRO Regelset X-147 + I-147 Bus

 1087163		3	1	Set	1230,43
---	--	---	---	-----	---------

Uponor Smatrix Base PRO Regler X-147 Bus

 1087162		4	1	St.	599,62
---	--	---	---	-----	--------

Uponor Smatrix Base PRO Bedienmodul I-147 Bus

 1087161		7	1	St.	578,81
---	--	---	---	-----	--------

Art-Nr.	Dimension	LE	VE	ME	Preis/ME
---------	-----------	----	----	----	----------

Uponor Smatrix Base PRO Raumtemperatur-Feuchtfühler Style T-141 Bus









 1087812	FLUSH	180	1	St.	94,81
---	-------	-----	---	-----	-------







Uponor Smatrix Base PRO KNX Schnittstelle R-147 KNX

 1087164		-	1	St.	771,64
---	--	---	---	-----	--------



OUT Lieferung solange Vorrat reicht.
Artikel läuft im Laufe des Jahres aus.



Uponor Base

Art-Nr.	Dimension	LE	VE	ME	Preis/ME
 1058426	6X 230V	200	1	St.	135,57
 1058427	230V	-	1	St.	36,40
 1088331	6X 230V	-	1	St.	160,61
 1089086	6X 230V	-	1	St.	168,93
 1089087	8X 230V	-	1	St.	178,34
 1089088	8X 230V	-	1	St.	196,08
 1058422	230V RAL9010	160	1	St.	42,45
 1058423	230V	-	1	St.	79,58

Art-Nr.	Dimension	LE	VE	ME	Preis/ME
 1058424	230V	-	1	St.	59,34
 1058425	230V RAL9010	-	1	St.	114,69
 1047459	230V	-	1	St.	20,23
 1087763	230V	100	1	Set	33,69
 1090263	VA02 MT 30x1,5	100	1	St.	63,62
 1090265	VA32 FT 28x1,5	100	1	St.	63,62

Uponor Space

Art-Nr.	Dimension	LE	VE	ME	Preis/ME
 1000314	24V	-	1	St.	191,91
 1000312	24V	10	1	St.	153,31
 1000313	24V	25	1	St.	153,31

Art-Nr.	Dimension	LE	VE	ME	Preis/ME
 1005107	1/2" - G3/4	50	1	St.	25,97
<i>Passende Verschraubungen finden Sie im Kapitel Verteiler und Zubehör</i>					
 1005108	1/2" - G3/4	50	1	St.	25,29
 1005100	G1 - Rp1	10	1	Set	75,66

OUT Lieferung solange Vorrat reicht. Artikel läuft im Laufe des Jahres aus.



Übersicht Uponor Stellantriebe

<p>Uponor Vario PLUS Thermoantrieb PRO 24 V 1000138 MT 30x1,5</p>  <p>Uponor Vario PLUS Thermoantrieb PRO 230 V 1005605</p>	<p>Uponor Vario Thermoantrieb S 24 V 1013008 FT 30x1,5</p>  <p>Uponor Vario Thermoantrieb S 230 V 1013006 FT 30x1,5</p>	<p>Uponor Vario B Thermoantrieb PRO 24 V 1007249 FT 28x1,5</p>  <p>Uponor Vario B Thermoantrieb PRO 230 V 102244 FT 28x1,5</p>
<p>Uponor Vario PLUS</p> 	<p>Vario S Edelstahlverteiler ST FM und DFC</p> <p>ab 2019 (vorm. „Smart S“ bis 2018)</p> 	<p>Ersatzteil Uponor Fluvia T</p> 
<p>Uponor Magna Industrie- heizungs- verteiler</p> 	<p>Vario S Edelstahl- verteiler ST LS</p> <p>ab 2019 (vorm. „Smart S“ bis 2018)</p> 	<p>Ersatzteil Polytherm ohne DF</p> 
<p>Uponor Vario Regulier- ventil</p> 	<p>Vario M mit Durch- flussmesser FM</p> 	<p>Ersatzteil Polytherm DF</p> 
<p>Uponor Vario RL-Ventil</p> 	<p>Comfort Port vormontierte Verteiler- stationen</p> 	<p>Ersatzteil Unipipe</p>
<p>Ersatzteile Velta Kompakt und Velta Euro-Verteiler</p> 	<p>Vario S Edelstahl- verteiler ST LS (bis 2018)</p> 	<p>Ersatzteil 28x1.5</p>
	<p>Vario S Edelstahl- verteiler ST FM (bis 2018)</p> 	
	<p>Ersatzteil Chronatherm</p>	
<p>Bis 2021</p>		
<p>Uponor Vario PLUS 24 V 1090262</p> <p>Uponor Vario PLUS 230 V 1090263</p>  <p>Adapter VA 02 30 x 1,5 AG</p>	<p>Uponor Vario Thermoantrieb S 24 V 1087778</p> <p>Uponor Vario Thermoantrieb S 230 V 1087763</p>  <p>Adapter VA 50 30 x 1,5 IG</p>	<p>Uponor Vario B 24 V 1090264</p> <p>Uponor Vario B 230 V 1090265</p>  <p>Adapter VA 32 28 x 1,5 IG</p>



Uponor Vario

Art-Nr.	Dimension	LE	VE	ME	Preis/ME
---------	-----------	----	----	----	----------

Uponor Vario PLUS Thermoantrieb PRO 24V 1W NC

 	1090262	VA02 MT 30x1,5	100	1	St.	63,62
---	----------------	----------------	-----	---	-----	--------------



Uponor Vario B Thermoantrieb PRO 24V 1W NC

 	1090264	VA32 FT 28x1,5	100	1	St.	63,62
---	----------------	----------------	-----	---	-----	--------------

Uponor Vario PLUS Thermoantrieb PRO 230V 1W NC

 	1090263	VA02 MT 30x1,5	100	1	St.	63,62
---	----------------	----------------	-----	---	-----	--------------

Uponor Vario B Thermoantrieb PRO 230V 1W NC

 	1090265	VA32 FT 28x1,5	100	1	St.	63,62
---	----------------	----------------	-----	---	-----	--------------

Uponor Vario PLUS Stellantrieb 100kOhm

	1005544	24V NC MT30x1,5 0-10V DC	100	1	St.	157,46
---	----------------	--------------------------	-----	---	-----	---------------

Art-Nr.	Dimension	LE	VE	ME	Preis/ME
---------	-----------	----	----	----	----------

Uponor Vario VL-Feinregulierventil

	1005107	1/2" - G3/4	50	1	St.	25,97
---	----------------	-------------	----	---	-----	--------------

Passende Verschraubungen finden Sie im Kapitel Verteiler und Zubehör

Uponor Vario RL-Ventil

	1005108	1/2" - G3/4	50	1	St.	25,29
---	----------------	-------------	----	---	-----	--------------

Uponor Vario Regulierventil

	1005100	G1 - Rp1	10	1	Set	75,66
---	----------------	----------	----	---	-----	--------------

Uponor Smatrix

Art-Nr.	Dimension	LE	VE	ME	Preis/ME
---------	-----------	----	----	----	----------

Uponor Smatrix Transformator A-1XX

	1071677		12	1	St.	165,84
---	----------------	--	----	---	-----	---------------

Uponor Smatrix Thermoantrieb Retrofit A-XXX

	1083575	24V, NC, 1W	100	1	Set	51,63
---	----------------	-------------	-----	---	-----	--------------

Uponor Vario Thermoantrieb S

 	1087778	24V	100	1	Set	33,69
---	----------------	-----	-----	---	-----	--------------

Art-Nr.	Dimension	LE	VE	ME	Preis/ME
---------	-----------	----	----	----	----------

Uponor Smatrix Schaltmodul H/K M-1XX

	1083576	24V	84	1	St.	135,57
---	----------------	-----	----	---	-----	---------------

Uponor Smatrix Schaltmodul H/K M-1XX

	1083577	230V	16	1	St.	147,03
---	----------------	------	----	---	-----	---------------

Uponor Smatrix Boden- oder Fernfühler S-1XX

	1071684		63	1	St.	35,67
---	----------------	--	----	---	-----	--------------

Uponor Smatrix Wandrahmen T-X A-1XX

	1086986	RAL9016	250	1	St.	6,78
---	----------------	---------	-----	---	-----	-------------

Uponor Smatrix Move PRO

Art-Nr.	Dimension	LE	VE	ME	Preis/ME
---------	-----------	----	----	----	----------

Uponor Smatrix Move PRO Regler X-159

 1087155		10	1	St.	2200,72
--	--	----	---	-----	----------------

Uponor Smatrix Move PRO Regelung Schnee-Eisfreiheit Set S-152 + S-158

 1087158		-	1	Set	2346,40
1087156		5	1	St.	1147,15

Art-Nr.	Dimension	LE	VE	ME	Preis/ME
---------	-----------	----	----	----	----------

Uponor Smatrix Move PRO Raumfühler S-155

 1087159		10	1	St.	134,54
--	--	----	---	-----	---------------

Uponor Smatrix Move PRO Feuchtfühler S-157

 1087160		75	1	St.	547,49
--	--	----	---	-----	---------------

Uponor Smatrix Move PRO Kondensationsschutz Set S-159

 1087165		10	1	Set	531,75
--	--	----	---	-----	---------------

Uponor Smatrix Move

Art-Nr.	Dimension	LE	VE	ME	Preis/ME
---------	-----------	----	----	----	----------

Uponor Smatrix Move Heizen Regler X-157 Wired

 1071693		4	1	Set	886,40
--	--	---	---	-----	---------------

Uponor Smatrix Move PLUS Antenne A-155 Radio

 1071676		21	1	St.	165,84
--	--	----	---	-----	---------------

Uponor Smatrix Move Vorl./Rücklauffühler S-152

 1071661	3m	63	1	St.	84,80
--	----	----	---	-----	--------------

Uponor Smatrix Move Mischermotor 230V

 1002357		-	1	St.	196,06
--	--	---	---	-----	---------------

Art-Nr.	Dimension	LE	VE	ME	Preis/ME
---------	-----------	----	----	----	----------

Uponor Fluvia Move PLUS Mischermotor 230V

 1119812	CPG+MPG ab 03/21	10	1	St.	275,00
1084560	CPG+MPG bis 03/21	10	1	St.	226,32

Uponor Smatrix Außenfühler S-1XX

 1071671		45	1	St.	109,51
--	--	----	---	-----	---------------

Uponor Smatrix Schaltmodul H/K M-1XX

 1083577	230V	16	1	St.	147,03
--	------	----	---	-----	---------------

Uponor Fluvia Move

Flächenheizung und -kühlung

Regelungstechnik

Art-Nr.	Dimension	LE	VE	ME	Preis/ME
---------	-----------	----	----	----	----------

Uponor Fluvia Move Pumpengruppe MPG-10-A-W

	1078306		30	1	St.	2836,94
---	----------------	--	----	---	-----	----------------

Uponor Fluvia Pumpengruppe MPG-10-B-W

	1078307		30	1	St.	1188,97
---	----------------	--	----	---	-----	----------------

Uponor Fluvia Move Pumpengruppe Push-23-A-AC

	1085008		30	1	St.	1428,83
---	----------------	--	----	---	-----	----------------

Uponor Fluvia Move 2-Wege-Stellantrieb Push-23-A-AC

	OUT 1086665	230V	16	1	St.	258,63
---	---------------------------	------	----	---	-----	---------------

Uponor Fluvia Move Pumpengruppe CPG-15-C-W

	NEU 1119445		18	1	St.	1950,00
---	---------------------------	--	----	---	-----	----------------

Uponor Fluvia Move Pumpengruppe CPG-15-A-W

	OUT 1078308		18	1	St.	3253,88
---	---------------------------	--	----	---	-----	----------------

Uponor Fluvia Pumpengruppe CPG-15-D-W

	NEU 1119448		18	1	St.	990,00
---	---------------------------	--	----	---	-----	---------------

Uponor Fluvia Pumpengruppe CPG-15-B-W

	1078309		18	1	St.	1480,99
---	----------------	--	----	---	-----	----------------

Art-Nr.	Dimension	LE	VE	ME	Preis/ME
---------	-----------	----	----	----	----------

Uponor Fluvia Move Pumpengruppe PPG-30-A-W

	1084143		22	1	St.	3243,65
---	----------------	--	----	---	-----	----------------

Uponor Smatrix Move Mischermotor pro

	1002356	A-15X 24V 0-10 V	-	1	St.	268,03
---	----------------	------------------	---	---	-----	---------------

Uponor Smatrix Move Mischermotor 230V

	1002357		-	1	St.	196,06
---	----------------	--	---	---	-----	---------------

Uponor Fluvia Move PLUS Mischermotor 230V

	NEU 1119812	CPG+MPG ab 03/21	10	1	St.	275,00
	OUT 1084560	CPG+MPG bis 03/21	10	1	St.	226,32

Uponor Fluvia Max.-Begrenzungstherm.

	1005504	5-60°	10	1	St.	60,70
--	----------------	-------	----	---	-----	--------------

Uponor Fluvia Move PLUS Pumpengruppe EPG-6-A-W

	1078310		8	1	St.	3848,47
---	----------------	--	---	---	-----	----------------

Uponor Fluvia E Mischventil für 1048780 MPG















	1071964		-	1	St.	199,18
---	----------------	--	---	---	-----	---------------







Uponor Fluvia Dreiwegemischer CPG

	NEU 1119813		10	1	St.	165,00
---	---------------------------	--	----	---	-----	---------------

OUT Lieferung solange Vorrat reicht. Artikel läuft im Laufe des Jahres aus.

Uponor Fluvia T

Art-Nr.	Dimension	LE	VE	ME	Preis/ME
Uponor Fluvia T Pumpengruppe Push-12 TH-G					
 1095127		60	1	St.	589,21
Uponor Fluvia T Pumpengruppe Push-12 CH-G					
 1095131		30	1	St.	1387,11
Uponor Fluvia T Regeleinheit Push-12-CH-X					
 1085982		50	1	St.	782,08
Uponor Fluvia T Pumpengruppe Push-12 AC-G					
 1095128		60	1	St.	698,75
Uponor Fluvia T Pumpengruppe Push-12 WL-G					
 1095130		60	1	St.	933,33
Uponor Fluvia T control KIT Push-12 WL-REC-AC					
 1071999	WL-REC-AC	10	1	St.	310,77
Uponor Fluvia T Dämmschale Push-12					
  1067394		10	1	St.	27,85
Uponor Fluvia Hosenstück					
 1005675	2xG $\frac{3}{4}$ - $\frac{3}{4}$ "Euro	50	1	Set	34,42
Uponor Vario Füll-Entleerungshahn					
 1061802	$\frac{3}{4}$ " - $\frac{3}{4}$ "	10	1	Set	56,21
Uponor Aqua PLUS Verteilerkappe m. Dichtung					
 1001337	$\frac{3}{4}$ "FT	250	10	St.	4,86
Uponor Vario B Stellantrieb NC					
  1007249	24V FT28x1,5	10	1	St.	61,00
  1022244	230V FT28x1,5	10	1	St.	61,00

Art-Nr.	Dimension	LE	VE	ME	Preis/ME
Uponor Fluvia T Pumpengruppe Push-23-B-W					
 1078304		55	1	St.	922,86
Uponor Vario Anschlussstück					
 1058573	G1-G1A	30	1	St.	20,34
Uponor Fluvia Pumpe Wilo Para SC					
  1095309	6m, 180mm*	-	1	St.	550,00
*BL 180 mm ist passend für Pumpengruppe CPG					
Uponor Fluvia T Grundfos Pumpenkopf Push-12					
 1095132		20	1	St.	257,60
Uponor Fluvia Pumpe Wilo Yonos Para					
 1059854	RS15/6 G1 130mm*	-	1	St.	677,93
*BL 130 mm ist passend für Pumpengruppe MPG					
Uponor Fluvia T Thermostat mit Fernfühler Push-23					
 1063461		-	1	St.	100,44
Uponor Fluvia Rücklauf-Regulierventil PUSH-23 u. MPG Push-23					
 1059282		10	1	St.	38,78
Uponor Fluvia Vorlauf-Thermostatventil PUSH-23 Push-23					
 1059283		10	1	St.	38,78
Uponor Fluvia Ventil für Push 12 Push-12					
 1059851		-	1	St.	116,80
Uponor Fluvia Thermostat für 1059834 PUSH 12 TH Push-12 TH					
 1059852		-	1	St.	103,88
Uponor Fluvia Mischventil für PUSH-23 Push-23					
 1061525	$\frac{3}{4}$ x G1 x G1	-	1	St.	99,08













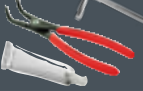





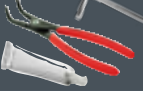



 Lieferung solange Vorrat reicht. Artikel läuft im Laufe des Jahres aus.

Verbindungstechnik, Fittings und Werkzeuge für Uponor Ecoflex Rohre





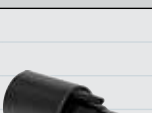

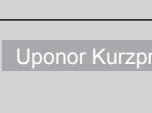









HEIZEN UND KÜHLEN

Systemrohr	Abmessung [mm]	Medium- rohr	Dämmung	Mantel- rohr	Temperatur- und Druckbelastung	Länge [m]	Artikel-Nr.	Zertifizierung
Thermo VIP Single 	40 x 3,7/140	PE-Xa + EVOH	VIP + PEX-Schaum	PE-HD	max. 95 °C / 6 bar	200	1095714	CSTB System-zertifizierung
	50 x 4,6/140					200	1095715	
	63 x 5,8/140					200	1095716	
	75 x 6,8/140					200	1095717	
	90 x 8,2/175					100	1095718	
	110 x 10,0/175					100	1095719	
	125 x 11,4/200					120	1095720	
Thermo VIP Twin 	2x25 x 2,3/140	PE-Xa + EVOH	VIP + PEX-Schaum	PE-HD	max. 95 °C / 6 bar	200	1118580	CSTB System-zertifizierung
	2x32 x 2,9/140					200	1118581	
	2x40 x 3,7/175					200	1118582	
	2x50 x 4,6/175					200	1118583	
	2x63 x 5,8/200					100	1118584	
	2x75 x 6,8/250					100	1118585	
	Thermo Single <small>optional mit Heizkabel</small> 					25 x 2,3/140	PE-Xa + EVOH	
32 x 2,9/140		200	1018110					
40 x 3,7/175		200	1018111					
50 x 4,6/175		200	1018112					
63 x 5,8/175		200	1018113					
75 x 6,8/200		100	1018114					
90 x 8,2/200		100	1018115					
110 x 10,0/200		100	1018116					
125 x 11,4/250		120	1083868					
Thermo Twin 		2x25 x 2,3/175	PE-Xa + EVOH	PEX-Schaum	PE-HD	max. 95 °C / 6 bar		200
	2x32 x 2,9/175	200					1018135	
	2x40 x 3,7/175	200					1018136	
	2x50 x 4,6/200	100					1018137	
	2x63 x 5,8/200	100					1018138	
	2x75 x 6,8/250	100					1088276	
Thermo Mini 	25 x 2,3/68	PE-Xa + EVOH	PEX-Schaum	PE-HD	max. 95 °C / 6 bar	200	1018132	CSTB System-zertifizierung
	32 x 2,9/68					200	1018133	
Thermo Twin HP* 	2x32 x 2,9-2x32 x 3,5/140	PE-Xa + EVOH	PEX-Schaum	PE-HD	max. 95 °C / 6 bar	200	1093894	
	2x40 x 3,7-2x32 x 3,5/175					200	1093895	
* Integrierte Leerrohre für Kabel								
Thermo PRO Single 	40 x 3,7/175	PE-Xa + EVOH	PUR-Schaum	PE-HD	max. 95 °C / 6 bar	150	1087379	CSTB System-zertifizierung
	50 x 4,6/175					150	1087384	
	63 x 5,8/175					150	1087385	
	75 x 6,8/200					100	1087388	
	90 x 8,2/200					100	1087389	
	110 x 10,0/200					100	1087390	
Thermo PRO Twin 	2x25 x 2,3/175	PE-Xa + EVOH	PUR-Schaum	PE-HD	max. 95 °C / 6 bar	150	1087393	CSTB System-zertifizierung
	2x32 x 2,9/175					150	1087395	
	2x40 x 3,7/175					150	1087396	
	2x50 x 4,6/200					100	1087398	
	2x63 x 5,8/200					100	1087399	

Verbindungstechnik und Werkzeuge

	Wipex Übergangs-nippel 		Ecoflex Übergangs-nippel 	Quick & Easy 			
Zubehör	PN6 + Grafitpaste + Aufspreizzange + Inbus 	PN6 + Grafitpaste + Inbus 	PN6 + Grafitpaste + Inbus 	Aufweitwerkzeuge M18 6 bar 	M18 VLD 	Ringe natural 	weiß 
Gummi-Endkappe							
	•						
	•	•					
	•		•				•
	•						•
	•	•					
	•	•					
	•	•					
	•	•					

Verbindungstechnik, Fittings und Werkzeuge für Uponor Ecoflex Rohre

	Systemrohr	Abmessung [mm]	Medium- rohr	Däm- mung	Mantel- rohr	Temperatur- und Druckbelastung	Länge [m]	Artikel-Nr.	Zertifizierung	Zubehör Gummi- Endkappe
HEIZEN UND KÜHLEN		25 x 2,3/90	PE-Xa + EVOH	PEX- Schaum	PE-HD	max. 95 °C / 6 bar	200	1018230	CSTB System- zertifizierung	
		32 x 2,9/90					200	1018231		
		40 x 3,7/140					200	1018232		
		50 x 4,6/140					200	1018233		
		63 x 5,8/140					200	1018234		
		75 x 6,8/175					200	1018235		
		90 x 8,2/175					100	1018236		
		110 x 10,0/175					100	1018237		
		125 x 11,4/200					120	1062886		
		HEIZEN UND KÜHLEN						2x25 x 2,3/140		
2x32 x 2,9/140	200		1018239							
2x40 x 3,7/140	200		1018240							
2x50 x 4,6/175	200		1018241							
TRINKWASSER WARM		40 x 5,5/140	PE-Xa	VIP + PEX- Schaum	PE-HD	max. 95 °C / 10 bar	200	1119047	DVGW, ÖVGW	
		50 x 6,9/140					200	1119048		
		63 x 8,6/140					200	1119049		
TRINKWASSER WARM		25 x 3,5-20 x 2,8/140	PE-Xa	VIP + PEX- Schaum	PE-HD	max. 95 °C / 10 bar	200	1119053	DVGW, ÖVGW	
		32 x 4,4-20 x 2,8/140					200	1119054		
		40 x 5,5-25 x 3,5/140					200	1119055		
		50 x 6,9-32 x 4,4/175					200	1119056		
TRINKWASSER WARM		25 x 3,5/140	PE-Xa	PEX- Schaum	PE-HD	max. 95 °C / 10 bar	200	1018117	DVGW, ÖVGW	
		32 x 4,4/140					200	1018118		
		40 x 5,5/175					200	1018119		
		50 x 6,9/175					200	1018120		
		63 x 8,6/175					200	1018121		
TRINKWASSER WARM		25 x 3,5-25 x 3,5/175	PE-Xa	PEX- Schaum	PE-HD	max. 95 °C / 10 bar	200	1018139	DVGW, ÖVGW	
		32 x 4,4-25 x 3,5/175					200	1018140		
		40 x 5,5-25 x 3,5/175					200	1018141		
		50 x 6,9-25 x 3,5/175					200	1018142		
HEIZEN + TRINKWASSER WARM		2x25 x 2,3-2x25 x 3,5/175	PE-Xa + EVOH + PE-Xa	PEX- Schaum	PE-HD	max. 95 °C / 6 / 10 bar	200	1018147	DVGW, ÖVGW	
		2x32 x 2,9-2x25 x 3,5/175					200	1018148		
		2x32 x 2,9-32 x 4,4-25 x 3,5/175					200	1018149		
		2x40 x 3,7-32 x 4,4-20 x 2,8/200					100	1084891		
		2x40 x 3,7-40 x 5,5-25 x 3,5/200					100	1084890		
TRINKWASSER KALT/KÜHLEN		25 x 2,3/68	PE 100-RC schwarz mit blauen Streifen	PEX- Schaum	PE-HD	20 °C / 16 bar	200	1095722	DVGW	
		32 x 2,9/68					200	1095723		
		40 x 3,7/140					200	1095724		
		50 x 4,6/140					200	1095725		
		63 x 5,8/140					200	1095726		
		75 x 6,8/175					100	1095727		
		90 x 8,2/175					100	1095728		
		110 x 10,0/200					100	1095729		
TRINKWASSER KALT		25 x 2,3/68	PE 100-RC schwarz mit blauen Streifen	PEX- Schaum	PE-HD	20 °C / 16 bar	150	1095730	DVGW	
		32 x 2,9/68					150	1095731		
		40 x 3,7/140					150	1095734		
		50 x 4,6/140					150	1095736		
		63 x 5,8/140					150	1095737		
		75 x 6,8/175					150	1095738		
		90 x 8,2/200					100	1095739		
		110 x 10,0/200					100	1095740		

Uponor Ecoflex Nahwärmeversorgung

Art-Nr.	Dimension	LE	VE	ME	Preis/ME
---------	-----------	----	----	----	----------

NEU Uponor Ecoflex Thermo VIP

NEU Uponor Ecoflex Thermo VIP Single

 1095714	40X3,7/140	-	200 m	53,00
1095715	50X4,6/140	-	200 m	65,80
1095716	63X5,8/140	-	200 m	83,80
1095717	75X6,8/140	-	200 m	105,70
1095718	90X8,2/175	-	100 m	110,40
1095719	110X10,0/175	-	100 m	122,90
1095720	125X11,4/200	-	120 m	169,50

NEU Uponor Ecoflex Thermo VIP Twin

 1118580	2x25x2,3/140	-	200 m	56,00
1118581	2x32x2,9/140	-	200 m	65,40
1118582	2x40x3,7 /175	-	200 m	80,20
1118583	2x50x4,6/175	-	200 m	102,90
1118584	2x63x5,8/200	-	100 m	120,80
1118585	2x75x6,8/250	-	100 m	166,20

do1 x s1 = Vorlauf, do2 x s2 = Rücklauf

Art-Nr.	Dimension	LE	VE	ME	Preis/ME
---------	-----------	----	----	----	----------

Uponor Ecoflex Thermo PRO

Uponor Ecoflex Thermo PRO Single

 1087379	40X3,7/175	-	150 m	55,39
1087384	50X4,6/175	-	150 m	68,84
1087385	63X5,8/175	-	150 m	87,56
1087388	75X6,8/200	-	100 m	102,91
1087389	90X8,2/200	-	100 m	112,34
1087390	110X10,0/200	-	100 m	125,07

Uponor Ecoflex Thermo PRO Twin

 1087393	2X25X2,3 /175	-	150 m	58,50
1087395	2X32X2,9 /175	-	150 m	68,38
1087396	2X40X3,7 /175	-	150 m	83,87
1087398	2X50X4,6 /200	-	100 m	107,58
1087399	2X63X5,8 /200	-	100 m	126,26

do1 x s1 = Vorlauf, do2 x s2 = Rücklauf

Uponor Ecoflex Nahwärmeversorgung

Art-Nr.	Dimension	LE	VE	ME	Preis/ME
---------	-----------	----	----	----	----------

Uponor Ecoflex Thermo

Uponor Ecoflex Thermo Single

 1018109	25x2,3/140	-	200 m	31,78
1018110	32x2,9/140	-	200 m	39,03
1018111	40x3,7/175	-	200 m	48,14
1018112	50x4,6/175	-	200 m	59,84
1018113	63x5,8/175	-	200 m	76,14
1018114	75x6,8/200	-	100 m	93,55
1018115	90x8,2/200	-	100 m	97,69
1018116	110x10,0/200	-	100 m	108,76
1083868	125x11,4/250	-	120 m	164,58

Auf Wunsch mit Heizkabel (Raychem, HWAT-R) lieferbar. Lieferzeit auf Anfrage.

Uponor Ecoflex Thermo Twin

 1018134	2x25x2,3/175	-	200 m	50,87
1018135	2x32x2,9/175	-	200 m	59,46
1018136	2x40x3,7 /175	-	200 m	72,93
1018137	2x50x4,6/200	-	100 m	93,55
1018138	2x63x5,8/200	-	100 m	109,79
1088276	2x75x6,8/250	-	100 m	147,11

do1 x s1 = Vorlauf, do2 x s2 = Rücklauf

Uponor Ecoflex Thermo Mini

 1018132	25x2,3/68	-	200 m	23,29
1018133	32x2,9/68	-	200 m	28,88

Uponor Ecoflex Thermo Twin HP

 1093894	2x32x2,9-2x32x3,5/140	-	200 m	53,51
1093895	2x40x3,7-2x32x3,5/175	-	200 m	69,28

do1 x s1 = Vorlauf, Rücklauf
do2 x s2 = Leerrohr für Kabel

Art-Nr.	Dimension	LE	VE	ME	Preis/ME
---------	-----------	----	----	----	----------

Uponor Ecoflex Varia

Uponor Ecoflex Varia Single

 1018230	25x2,3 /90	-	200 m	28,67
1018231	32x2,9 /90	-	200 m	35,10
1018232	40x3,7 /140	-	200 m	43,38
1018233	50x4,6 /140	-	200 m	53,83
1018234	63x5,8 /140	-	200 m	68,53
1018235	75x6,8 /175	-	200 m	84,20
1018236	90x8,2 /175	-	100 m	87,92
1018237	110x10,0 /175	-	100 m	97,88
1062886	125x11,4/200	-	120 m	148,02

Uponor Ecoflex Varia Twin

 1018238	2x25x2,3/140	-	200 m	45,78
1018239	2x32x2,9/140	-	200 m	52,32
1018240	2x40x3,7/140	-	200 m	65,64
1018241	2x50x4,6/175	-	200 m	84,20

do1 x s1 = Vorlauf, do2 x s2 = Rücklauf

Uponor Ecoflex Nahwärmeversorgung

Art-Nr.	Dimension	LE	VE	ME	Preis/ME
---------	-----------	----	----	----	----------

NEU Uponor Ecoflex Aqua VIP

NEU Uponor Ecoflex Aqua VIP Single

 1119047	40x5,5/140	-	200 m	77,20
1119048	50x6,9/140	-	200 m	90,90
1119049	63x8,6/140	-	200 m	115,00

NEU Uponor Ecoflex Aqua VIP Twin

 1119053	25x3,5-20x2,8/140	-	200 m	58,80
1119054	32x4,4-20x2,8/140	-	200 m	72,10
1119055	40x5,5-25x3,5/140	-	200 m	85,80
1119056	50x6,9-32x4,4/175	-	200 m	117,60

do1 x s1 = Trinkwasser warm, do2 x s2 = Zirkulation

NEU Voraussichtlich ab 2. Quartal 2021 lieferbar.

Art-Nr.	Dimension	LE	VE	ME	Preis/ME
---------	-----------	----	----	----	----------

Uponor Ecoflex Aqua

Uponor Ecoflex Aqua Single

 1018117	25x3,5/140	-	200 m	40,80
1018118	32x4,4/140	-	200 m	44,58
1018119	40x5,5/175	-	200 m	70,19
1018120	50x6,9/175	-	200 m	82,61
1018121	63x8,6/175	-	200 m	104,54

Auf Wunsch mit Heizkabel (Raychem, HWAT-R) lieferbar. Lieferzeit auf Anfrage.

Uponor Ecoflex Aqua Twin

 1018139	25x3,5-25x3,5/175	-	200 m	53,46
1018140	32x4,4-25x3,5/175	-	200 m	65,56
1018141	40x5,5-25x3,5/175	-	200 m	78,00
1018142	50x6,9-25x3,5/175	-	200 m	106,91

Uponor Ecoflex Nahwärmerversorgung

Art-Nr.	Dimension	LE	VE	ME	Preis/ME
---------	-----------	----	----	----	----------

Art-Nr.	Dimension	LE	VE	ME	Preis/ME
---------	-----------	----	----	----	----------

Uponor Ecoflex Quattro

Uponor Ecoflex Supra

Uponor Ecoflex Quattro

	1018147	2x25x2,3-2x25x3,5/175	-	200 m	98,11
	1018148	2x32x2,9-2x25x3,5/175	-	200 m	109,62
	1018149	2x32x2,9-32x4,4-25x3,5/175	-	200 m	117,23
	1084891	2x40x3,7-32x4,4-20x2,8/200	-	100 m	123,07
	1084890	2x40x3,7-40x5,5-25x3,5/200	-	100 m	126,81

Uponor Ecoflex Supra

	1095722	25x2,3/68	-	200 m	20,65
	1095723	32x2,9/68	-	200 m	24,09
	1095724	40x3,7/140	-	200 m	31,78
	1095725	50x4,6/140	-	200 m	35,24
	1095726	63x5,8/140	-	200 m	36,50
	1095727	75x6,8/175	-	150 m	43,96
	1095728	90x8,2/175	-	100 m	46,32
	1095729	110x10,0/200	-	100 m	62,20

Uponor Ecoflex Nahwärmeversorgung

Art-Nr.	Dimension	LE	VE	ME	Preis/ME
---------	-----------	----	----	----	----------

Art-Nr.	Dimension	LE	VE	ME	Preis/ME
---------	-----------	----	----	----	----------

Uponor Ecoflex Supra PLUS

Uponor Ecoflex Supra PLUS cable

	1095730	25x2,3/68	1x10W/m	-	150 m	41,38
	1095731	32x2,9/68	1x10W/m	-	150 m	46,02
	1095734	40x3,7/140	1x10W/m	-	150 m	54,28
	1095736	50x4,6/140	1x10W/m	-	150 m	58,16
	1095737	63x5,8/140	1x10W/m	-	150 m	60,44
	1095738	75x6,8/175	1x10W/m	-	150 m	75,50
	1095739	90x8,2/200	1x10W/m	-	100 m	100,58
	1095740	110x10,0/200	1x10W/m	-	100 m	109,54

Uponor Ecoflex Supra PLUS Set

	1048697	25+32/68		-	1 St.	338,77
	1048699	40+50+63/140		-	1 St.	376,05
	1048700	75/175		-	1 St.	435,11
	1048702	90+110/200		-	1 St.	476,52

Uponor Ecoflex Supra PLUS Regler 150

	1048703			-	1 St.	300,43
---	----------------	--	--	---	-------	---------------

Uponor Ecoflex Supra PLUS Kabel-Set S1

	1042310	S1		-	1 St.	60,09
---	----------------	----	--	---	-------	--------------

Uponor Ecoflex Supra PLUS Kabel-Set S2

	1042311	S2		-	1 St.	134,68
--	----------------	----	--	---	-------	---------------

Uponor Ecoflex Supra PLUS T-Set

	1061641	140/90/68		5	1 St.	486,90
	1061642	200/175/140		3	1 St.	559,29

Uponor Ecoflex Reduzierring

	1060991	200/68		8	1 St.	9,32
---	----------------	--------	--	---	-------	-------------

Uponor Wipex

Art-Nr.	Dimension	LE	VE	ME	Preis/ME
 1018328	25x2,3-G1	40	1	St.	46,10
1018329	32x2,9-G1	20	1	St.	50,45
1018330	40x3,7-G1 ¼	10	1	St.	62,16
1018331	50x4,6-G1 ¼	10	1	St.	71,90
1018332	63x5,8-G2	8	1	St.	90,44
1018333	75x6,8-G2	6	1	St.	123,21
1018334	90x8,2-G3	4	1	St.	170,86
1018335	110x10,0-G3	3	1	St.	205,03

Uponor Ecoflex Übergangsnippel PN6

 1078368	125x11,4-R4	-	1	St.	332,42
--	-------------	---	---	-----	---------------

Uponor Ecoflex Übergangsnippel PN10

 1091505	20x2,8-¾"	10	1	St.	43,60
--	-----------	----	---	-----	--------------

Uponor Wipex Übergangsnippel PN10

 1018336	25x3,5-G1	40	1	St.	47,64
1018338	32x4,4-G1	20	1	St.	52,92
1018339	40x5,5-G1 ¼	10	1	St.	65,66
1018340	50x6,9-G1 ¼	10	1	St.	71,98
1018341	63x8,6-G2	8	1	St.	90,10

Uponor Wipex Kupplung PN6

 1042972	25x2,3-25x2,3	30	1	St.	91,76
1042973	32x2,9-32x2,9	25	1	St.	100,04
1042980	40x3,7-40x3,7	15	1	St.	118,04
1042984	50x4,6-50x4,6	10	1	St.	135,64
1042981	63x5,8-63x5,8	5	1	St.	170,88
1042985	75x6,8-75x6,8	3	1	St.	243,35
1042986	90x8,2-90x8,2	4	1	St.	333,46
1042987	110x10-110x10	2	1	St.	402,84

Uponor Ecoflex Kupplung PN6

 1078365	125x11,4-125x11,4	-	1	St.	466,02
--	-------------------	---	---	-----	---------------

Uponor Wipex Kupplung PN10

 1042970	25x3,5-25x3,5	40	1	St.	93,00
1042974	32x4,4-32x4,4	25	1	St.	102,01
1042979	40x5,5-40x5,5	15	1	St.	120,12
1042983	50x6,9-50x6,9	10	1	St.	137,73
1042982	63x8,6-63x8,6	4	1	St.	195,72

Art-Nr.	Dimension	LE	VE	ME	Preis/ME
 1018345	G1-G1-G1	20	1	St.	27,55
1018346	G1 ¼-G1 ¼-G1 ¼	10	1	St.	36,66
1018347	G2-G2-G2	4	1	St.	54,47
1018348	G3-G3-G3	3	1	St.	126,35

Uponor Ecoflex T-Stück

 1078367	Rp4-Rp4-Rp4	-	1	St.	147,05
--	-------------	---	---	-----	---------------

Uponor Wipex Winkel

 1018350	G1-G1	20	1	St.	28,37
1018351	G1 ¼-G1 ¼	15	1	St.	29,93
1018352	G2-G2	5	1	St.	49,50
1018353	G3-G3	2	1	St.	107,69

Uponor Ecoflex Winkel

 1078366	Rp4-Rp4	-	1	St.	146,00
---	---------	---	---	-----	---------------

Uponor Wipex Gewindemuffe

 1018355	G1-G1	40	1	St.	21,85
1018356	G1 ¼-G1 ¼	25	1	St.	26,61
1018357	G2-G2	15	1	St.	41,01
1018358	G3-G3	10	1	St.	67,52

Uponor Wipex Reduzierung

 1018368	G1 ¼-G1	25	1	St.	19,88
1018369	G1 ½-G1 ¼	25	1	St.	45,26
1018371	G2-G1	15	1	St.	63,90
1018372	G2-G1 ¼	15	1	St.	59,65
1018373	G2 ½-G2	6	1	St.	104,57
1018374	G3-G1	6	1	St.	104,60
1018375	G3-G1 ¼	10	1	St.	108,71
1018376	G3-G2	10	1	St.	109,74
1009052	G4-G3	6	1	St.	145,99

Uponor Ecoflex Reduzierung

 1078369	R4-G3	6	1	St.	110,81
--	-------	---	---	-----	---------------

Uponor Wipex

Art-Nr.	Dimension	LE	VE	ME	Preis/ME
---------	-----------	----	----	----	----------

Uponor Wipex Gewindeflansch

 1018359	F25/4-85/G1	10	1	St.	126,32
1018360	F32/4-100/G1 ¼	5	1	St.	156,35
1018361	F40/4-110/G1 ½	5	1	St.	160,49
1018362	F50/4-125/G2	4	1	St.	236,10
1018363	F65/8-145/2 ½	3	1	St.	302,39
1018364	F80/8-160/G3	3	1	St.	321,04
1018365	F100/8-180/G4	3	1	St.	427,70

Uponor Ecoflex Gewindeflansch

 1078370	F100/8-180/Rp4	-	1	St.	214,36
--	----------------	---	---	-----	---------------

Uponor Wipex Drehnippel

 1045455	G1	20	1	St.	57,48
1045456	G1 ¼-G1	20	1	St.	59,65
1045457	G1 ¼	15	1	St.	63,38
1065442	G1¼ 120mm	8	1	St.	84,30
1045458	G2-G1 ¼	10	1	St.	94,66
1045459	G2	10	1	St.	97,45
1065444	G2 120mm	3	1	St.	126,33
1045460	G3-G2	3	1	St.	192,59
1045461	G3	2	1	St.	326,22

Uponor Wipex Fixpunktmuffe

 1018302	G1	30	1	St.	54,06
1018303	G1 ¼	10	1	St.	68,66
1018304	G2	5	1	St.	110,79
1018305	G3	5	1	St.	209,20

Uponor Ecoflex Anschweißkupplung ST PN6 EU+GOST

 NEU 1094013	25x2,3-26,9	-	1	St.	84,40
NEU 1094014	32x2,9-33,7	-	1	St.	92,00
NEU 1094015	40x3,7-42,4	-	1	St.	108,60
NEU 1094016	50x4,6-48,3	-	1	St.	124,80
NEU 1094017	63x5,8-60,3	-	1	St.	157,20
NEU 1094018	75x6,8-76,1	-	1	St.	223,90
NEU 1094019	90x8,2-88,9	-	1	St.	306,80
NEU 1094020	110x10,0-114,3	-	1	St.	370,60
NEU 1094021	125x11,4-114,3	-	1	St.	565,00

Art-Nr.	Dimension	LE	VE	ME	Preis/ME
---------	-----------	----	----	----	----------

Uponor Wipex - MLC Presskupplung S-Press PN6

 1060058	32x2,9-32x3,0	25	1	St.	76,53
--	---------------	----	---	-----	--------------

Uponor Wipex - MLC Presskupplung S-Press PN6

 1060059	40x3,7-40x4,0	15	1	St.	91,34
1060060	50x4,6-50x4,5	10	1	St.	131,52

Uponor Wipex RS Adapter PN6

 1047013	DR 63x5,8 RS2	240	1	St.	90,00
--	---------------	-----	---	-----	--------------

Uponor Wipex Aufspreizzange

 1046407	1 - 1 ½	25	1	St.	30,41
--	---------	----	---	-----	--------------

Uponor Q&E

Art-Nr.	Dimension	LE	VE	ME	Preis/ME
---------	-----------	----	----	----	----------

Uponor Q&E Sicherungsring white

 1057455	25	300	20	St.	0,92
1057456	32	150	10	St.	1,74

Uponor Q&E Ring natural

 1045464	40	80	5	St.	2,97
1045489	50	70	5	St.	4,15
1045490	63	35	5	St.	6,53
1085087	75	18	2	St.	14,30

Uponor Q&E Winkel PPSU

 1008681	25-25	25	5	St.	9,53
1001245	32-32	15	1	St.	17,82
1008683	40-40	10	1	St.	29,73
1042859	50-50	5	1	St.	47,55
1042858	63-63	3	1	St.	71,28
1085080	75-75	2	1	St.	119,13

Uponor Q&E Kupplung PPSU

 1008671	25-25	50	5	St.	7,72
1001235	32-32	20	1	St.	11,91
1008673	40-40	10	1	St.	23,78
1042866	50-50	10	1	St.	35,64
1042865	63-63	5	1	St.	59,46
1085084	75-75	10	1	St.	119,13

Uponor Q&E Reduzierkupplung PPSU

 1001240	32-25	20	1	St.	17,82
1008678	40-32	10	1	St.	23,78
1042879	50-32	10	1	St.	35,64
1042867	50-40	10	1	St.	35,64
1042878	63-40	5	1	St.	59,46
1042877	63-50	5	1	St.	59,46
1085086	75-50	10	1	St.	118,77
1085085	75-63	10	1	St.	119,13

Uponor Q&E T-Stück PPSU

 1008686	25-25-25	25	5	St.	11,91
1001250	32-32-32	10	1	St.	23,78
1008688	40-40-40	5	1	St.	41,64
1042861	50-50-50	3	1	St.	71,28
1042860	63-63-63	2	1	St.	95,10
1085081	75-75-75	2	1	St.	142,95

Art-Nr.	Dimension	LE	VE	ME	Preis/ME
---------	-----------	----	----	----	----------

Uponor Q&E Reduzier-T-Stück PPSU

 1008712	25-32-25	15	1	St.	23,78
1001426	32-25-25	15	1	St.	23,78
1001428	32-25-32	15	1	St.	23,78
1008713	32-40-32	10	1	St.	41,64
1008708	40-25-32	5	1	St.	41,64
1008695	40-25-40	5	1	St.	41,64
1008709	40-32-32	5	1	St.	41,64
1008696	40-32-40	5	1	St.	41,64
1042876	50-25-40	4	1	St.	71,28
1042864	50-25-50	4	1	St.	71,28
1042863	50-32-50	4	1	St.	71,28
1042862	50-40-40	4	1	St.	71,28
1042875	50-40-50	4	1	St.	71,28
1042871	63-25-50	2	1	St.	95,10
1042873	63-25-63	2	1	St.	95,10
1042870	63-32-63	2	1	St.	95,10
1042869	63-40-40	2	1	St.	95,10
1042872	63-40-63	2	1	St.	95,10
1042868	63-50-50	2	1	St.	95,10
1042874	63-50-63	2	1	St.	95,10
1085083	75-25-75	4	1	St.	142,52
1085082	75-40-75	4	1	St.	142,52

Uponor Q&E Übergangsnippel PL

 1023007	25-R $\frac{3}{4}$ "MT	70	5	St.	17,82
1047191	32-R1"MT	10	1	St.	29,73

Uponor Q&E Übergangsnippel PL/DR

 1085077	40-R1 $\frac{1}{4}$ "MT	16	1	St.	47,55
1085076	50-R1 $\frac{1}{2}$ "MT	8	1	St.	59,46
1085075	63-R2"MT	6	1	St.	89,10
1085074	75-R2 $\frac{1}{2}$ "MT	6	1	St.	172,98

Uponor Q&E Winkel mit Innengewinde PL

 1023026	25-G $\frac{1}{4}$ "FT	35	5	St.	17,82
--	------------------------	----	---	-----	--------------

Uponor Q&E Übergangsmuffe PL

 1023012	25-Rp $\frac{3}{4}$ "FT	40	5	St.	17,82
--	-------------------------	----	---	-----	--------------

Uponor Ecoflex Systemzubehör

Art-Nr.	Dimension	LE	VE	ME	Preis/ME
---------	-----------	----	----	----	----------

Uponor Ecoflex Gummi-Endkappe, Single

 1018316	25+32+40/68	-	1	St.	23,46
1018246	25+32+40/90	-	1	St.	28,38
1018315	25+28+32/140+145	-	1	St.	30,25
1018313	32+40+50/175	-	1	St.	41,03
1018314	40+50+63/140+145	-	1	St.	34,08
NEU 1095801	63+75+90/140	-	1	St.	39,50
1018312	63+75/175	-	1	St.	44,44
1018310	75+90+110/200	-	1	St.	58,53
1018311	90+110/175	-	1	St.	56,67
1067757	125/200	-	1	St.	70,14
1083869	90+110+125/250	-	1	St.	83,19

Anz. = Anzahl Auslassstutzen

Uponor Ecoflex Gummi-Endkappe, Twin

NEU 1119374	18-22+25-28+32/140	-	1	St.	42,00
1018245	25+32+40/140+145	-	1	St.	48,17
1018309	25+32+40/175	-	1	St.	59,26
1018308	25+32+50/175	-	1	St.	61,33
1018307	40+50+63/200	-	1	St.	63,30
1088979	75+90/250	-	1	St.	78,42

Anz. = Anzahl Auslassstutzen

Uponor Ecoflex Gummi-Endkappe, Quattro

 1086838	20+25+32/140	-	1	St.	71,28
1018306	18-32+25-32/175	-	1	St.	71,28
1094252	25+32+40/175	-	1	St.	76,87
1034308	18-28+32+40/200	-	1	St.	108,77

Anz. = Anzahl Auslassstutzen

Uponor Ecoflex T-Isoliersatz

 1060986	140/90/68	5	1	St.	321,13
1060982	200/175/145/140	4	1	St.	387,44

Uponor Ecoflex Eckisoliersatz

 1060985	200/175/145/140	3	1	St.	283,86
--	-----------------	---	---	-----	---------------

Uponor Ecoflex Längsisoliersatz

 1060984	200/175/145/140	6	1	St.	300,42
--	-----------------	---	---	-----	---------------

Art-Nr.	Dimension	LE	VE	ME	Preis/ME
---------	-----------	----	----	----	----------

Uponor Ecoflex Reduzierring

 1060991	200/68	8	1	St.	9,32
1060990	200/90	8	1	St.	13,42
1085107	200/160	12	1	St.	12,95
1085106	200/205	12	1	St.	10,93

Uponor Ecoflex Mantelrohr-Verbindungsset

 1084574	175+200	10	1	St.	118,10
1083872	250	9	1	St.	120,16

Uponor Ecoflex H-Isoliersatz

 1007355	200/175/145/140	-	1	St.	652,58
--	-----------------	---	---	-----	---------------

Uponor Ecoflex Schacht

 1018326	6x140/145/175/200	-	3	St.	984,14
1018327	8x140/145/175/200	-	3	St.	1046,12
1084576	2x250-6x140/145/175/200	-	1	St.	1419,31
1084577	4x250-4x140/145/175/200	-	1	St.	1968,38
1084578	6x250-2x140/145/175/200	-	1	St.	2517,41

Uponor Ecoflex Dichtband

 1018382	50mm x 10m	-	1	St.	92,51
--	------------	---	---	-----	--------------

Uponor Ecoflex Schrumpfschlauch

 1018379	140/145	-	1	St.	30,35
1018380	175/200	-	1	St.	33,98
1084575	250	15	1	St.	64,02

di1 = Durchmesser ungeschumpft
di2 = minimaler Durchmesser geschumpft

NEU Uponor Ecoflex Hauseinführungsbogen Single

 1118765	50x4,6/140	-	1	St.	415,00
1118766	63x5,8/140	-	1	St.	435,00
1118767	75x6,8/140	-	1	St.	730,00

Lieferzeit auf Anfrage.

Uponor Ecoflex Hauseinführungsbogen Single

 1085108	75x6,8/205	-	1	St.	745,79
--	------------	---	---	-----	---------------

Lieferzeit auf Anfrage.

Uponor Ecoflex Systemzubehör

Art-Nr.	Dimension	LE	VE	ME	Preis/ME
---------	-----------	----	----	----	----------

NEU Uponor Ecoflex Hauseinführungsbogen Twin

 1118771	2x25x2,3/140	-	1	St.	380,00
1118772	2x32x2,9/140	-	1	St.	400,00
1118773	2x40x3,7/160	-	1	St.	470,00
1118774	2x50x4,6/200	-	1	St.	576,40
1118775	2x63x5,8/200	-	1	St.	730,00
1118776	2x75x6,8/250	-	1	St.	980,00

Lieferzeit auf Anfrage.

Uponor Ecoflex Hauseinführungsbogen Twin

 1096432	2x40x3,7/160	10	1	St.	490,00
1085104	2X50X4,6/205	-	1	St.	585,22
1085105	2X63X5,8/205	-	1	St.	766,62
1088822	2x75x6,8/250	-	1	St.	984,06

Lieferzeit auf Anfrage.

Uponor Ecoflex Mauerdurchführung DWD

 1007358	68	-	1	St.	208,21
1007359	90	-	1	St.	241,36
1007360	140/145	-	1	St.	274,52
1007361	175	-	1	St.	356,36
1007362	200	-	1	St.	458,95
1091429	250	-	1	St.	515,90

do = Kernlochbohrung

Uponor Ecoflex Ergänzungssatz NDW

 1007365	140/145	-	1	St.	161,60
1007366	175	-	1	St.	195,77
1007367	200	-	1	St.	290,07
1091430	250	-	1	St.	350,14

do = Kernlochbohrung

Uponor Ecoflex Faserzementrohr DWD

 1007368	68	-	1	St.	148,14
1007370	140/145	-	1	St.	152,29
1007371	175	-	1	St.	174,04
1007372	200	-	1	St.	239,30
1091431	250	-	1	St.	288,00

di = Innendurchmesser Faserzementrohr, do = Außendurchmesser Faserzementrohr

Uponor Ecoflex Epoxidharz Set für DWD

 1007373	1,1 kg/3,5m ²	-	1	Set	107,73
--	--------------------------	---	---	-----	---------------

Art-Nr.	Dimension	LE	VE	ME	Preis/ME
---------	-----------	----	----	----	----------

Uponor Ecoflex Mauerdurchführung NDW

 1018267	68+90	-	1	St.	40,61
1018269	140+145	-	1	St.	44,75
1018268	175+200	-	1	St.	49,52
1083871	250	16	1	St.	86,82

di = Innendurchmesser Mauerhülse, do = Außendurchmesser Mauerhülse

Uponor Ecoflex Labyrinthdichtung NDW

 1034202	140+145	40	1	St.	49,52
1034203	175	30	1	St.	52,01
1034204	200	20	1	St.	56,98
1090415	250	-	1	St.	79,56

di = Innendurchmesser Labyrinthdichtung, do = Außendurchmesser Labyrinthdichtung

Uponor Ecoflex Schrumpfmanschette

 1036014	140+145+175+200-700mm	-	1	St.	265,19
--	-----------------------	---	---	-----	---------------

di1 = Durchmesser ungeschrumpft
di2 = minimaler Durchmesser geschrumpft

Uponor Ecoflex Schrumpfband

 1093120	160mm x 10m	30	1	St.	110,83
--	-------------	----	---	-----	---------------

Uponor Ecoflex Trassenwarnband, rot

 1018385	40mm x 250m	-	1	St.	47,76
NEU 1105785	40mm x 30m	-	1	St.	17,00

Uponor Ecoflex Systemzubehör

Art-Nr.	Dimension	LE	VE	ME	Preis/ME
---------	-----------	----	----	----	----------

Uponor Q&E Grafitpaste

 1005017	100g	-	1	St.	22,63
--	------	---	---	-----	--------------

Uponor Ecoflex Dichtpaste

 1060996	750ml	-	1	St.	13,99
--	-------	---	---	-----	--------------

Uponor Ecoflex Spreiznieten

 1021997		-	1	St.	0,25
--	--	---	---	-----	-------------

Art-Nr.	Dimension	LE	VE	ME	Preis/ME
---------	-----------	----	----	----	----------

Uponor Ecoflex Schrauben-Set

 1021999		-	1	St.	0,83
--	--	---	---	-----	-------------

Uponor Ecoflex Schrauben-Set

 1060995	M6x30 (34pcs)	-	1	St.	13,57
--	---------------	---	---	-----	--------------

Uponor Ecoflex Supra PLUS Frostschutzkabel

 1044136	10W/m	-	1	m	17,66
--	-------	---	---	---	--------------

Uponor Ecoflex Mietwerkzeuge

Art-Nr.	Dimension	LE	VE	ME	Preis/ME
---------	-----------	----	----	----	----------

Uponor RNT Ecoflex Aufweitwerkzeug rent DACH Q&E

 1087649	M18 6BAR 25/32/40	-	1	St.	Preis auf Anfrage
--	-------------------	---	---	-----	--------------------------

Uponor RNT Ecoflex Aufweitwerkzeug rent DACH Q&E

 1087650	M18 10BAR 25/32	-	1	St.	Preis auf Anfrage
--	-----------------	---	---	-----	--------------------------

Uponor RNT Ecoflex Aufweitwerkzeug rent DACH Q&E

 1087651	M18 VLD 40-75	-	1	St.	Preis auf Anfrage
--	---------------	---	---	-----	--------------------------

Art-Nr.	Dimension	LE	VE	ME	Preis/ME
---------	-----------	----	----	----	----------

Uponor RNT Ecoflex Abroller rent DACH

 1087652	type 1	-	1	St.	Preis auf Anfrage
--	--------	---	---	-----	--------------------------

Uponor Ecoflex Rundungswerkz. rent DACH

 1085661	125	-	1	St.	Preis auf Anfrage
--	-----	---	---	-----	--------------------------

Werkzeuge

Art-Nr.	Dimension	LE	VE	ME	Preis/ME
---------	-----------	----	----	----	----------

Abrollen

Uponor MLC Rohrrichter



1010512	14-25	60	1	St.	430,74
---------	-------	----	---	-----	--------

Uponor Multi Teleskop-Abrollvorrichtung



1058662		-	1	St.	378,86
---------	--	---	---	-----	--------

Uponor Multi Abrollvorrichtung



1006255	120-960M	-	1	St.	470,19
---------	----------	---	---	-----	--------

Uponor Magna Abrollvorrichtung



1006256	25-640m	-	1	St.	923,66
---------	---------	---	---	-----	--------

Uponor Ecoflex Abroller



1036645	type1	-	1	St.	1722,95
---------	-------	---	---	-----	---------

Uponor Ecoflex Stationäre Abrollvorrichtung



NEU 1119057	< 600kg	-	1	St.	2850,00
--------------------	---------	---	---	-----	---------

Lieferzeit auf Anfrage.

Uponor Wipex Aufsprezzange



1046407	1 - 1 ½	25	1	St.	30,41
---------	---------	----	---	-----	-------

1046408	1 ½ - 3 ½	25	1	St.	33,84
---------	-----------	----	---	-----	-------

Art-Nr.	Dimension	LE	VE	ME	Preis/ME
---------	-----------	----	----	----	----------

Vorbereitung, Schneiden, Biegen

Uponor Multi Rohrschneider



1089674	12-25	36	1	St.	81,48
---------	-------	----	---	-----	-------

1089776	Ersatzklinge	150	1	St.	17,75
---------	--------------	-----	---	-----	-------

Uponor Multi Rohrschneider



1089677	32-40	12	1	St.	74,01
---------	-------	----	---	-----	-------

1089779	Ersatzklinge	50	1	St.	35,71
---------	--------------	----	---	-----	-------

Uponor Flex Rohrschneider PEX



NEU 1095265	50-63	12	1	St.	90,00
--------------------	-------	----	---	-----	-------

NEU 1095266	Ersatzklinge	50	1	St.	43,00
--------------------	--------------	----	---	-----	-------

Uponor Multi Rohrschneider



1089675	25-63	12	1	St.	70,58
---------	-------	----	---	-----	-------

1089777	Ersatzschneidrad	50	1	St.	8,15
---------	------------------	----	---	-----	------

Uponor Multi Rohrschneider



1089676	50-125	8	1	St.	131,81
---------	--------	---	---	-----	--------

1089778	Ersatzschneidrad	50	1	St.	9,81
---------	------------------	----	---	-----	------

Uponor Flex Rohrschneider PEX



1089673	12-25	36	1	St.	26,15
---------	-------	----	---	-----	-------

1089780	Ersatzklinge	150	1	St.	17,75
---------	--------------	-----	---	-----	-------

Uponor MLC Ersatzschneidrad



1006635	Ersatzschneidrad 25-63	1000	1	St.	8,15
---------	------------------------	------	---	-----	------

1014173	Ersatzschneidrad 50-110	20	1	St.	9,81
---------	-------------------------	----	---	-----	------

Werkzeuge

Art-Nr.	Dimension	LE	VE	ME	Preis/ME
---------	-----------	----	----	----	----------

Uponor MLC Rohrabschneider und Entgrater

 1014334	63-110	32	1	St.	581,24
1014320	63-110	100	1	St.	65,81

Uponor MLC Entgrater

 1006952	14	50	1	St.	26,98
1006830	16	50	1	St.	28,34
1015749	20	1200	1	St.	31,04
1015756	25	960	1	St.	32,80
1015762	32	900	1	St.	35,71

Uponor MLC Entgrater

 1006638	40	600	1	St.	36,74
1015808	50	600	1	St.	43,07
1014339	63	600	1	St.	51,90
1014344	75	600	1	St.	79,20

Uponor MLC Kombientgrater

 1015739	16/20/25	60	1	St.	49,41
---	----------	----	---	-----	--------------

Uponor MLC Universalentgrater

 1060167		50	1	St.	15,05
--	--	----	---	-----	--------------

Art-Nr.	Dimension	LE	VE	ME	Preis/ME
---------	-----------	----	----	----	----------

Uponor MLC Biegefeder innen

 1013727	14	1000	1	St.	10,74
1013729	16	100	1	St.	11,42
1013734	20	75	1	St.	14,53
1013737	25	50	1	St.	14,79
1013739	32	40	1	St.	22,32

Uponor MLC Biegefeder außen

 1006639	14	550	1	St.	13,23
1006640	16	55	1	St.	14,32
1013792	20	45	1	St.	18,22
1013794	25	45	1	St.	18,63

Uponor Uni Pipe PLUS Biegezange

 1071925	16-32	100	1	St.	429,70
--	-------	-----	---	-----	---------------

Uponor MLC Biegezange

 1013773	16-32	48	1	St.	398,55
---	-------	----	---	-----	---------------

Uponor RTM Kombikalibrierer

 1048606	16/20/25	20	1	St.	5,60
--	----------	----	---	-----	-------------

Pressen

Uponor S-Press Handzange o. Wechseleins.

 1015764	14-20	100	1	St.	320,71
--	-------	-----	---	-----	---------------

Uponor S-Press Wechseleinsätze

 1015776	14	400	1	St.	53,35
1015777	16	50	1	St.	53,35
1015780	20	50	1	St.	53,35

Uponor S-Press Akkumaschine UP 110 ohne Pressbacken

 1083612		20	1	Set	1712,47
--	--	----	---	-----	----------------

Uponor S-Press Ersatzakku UP 110

 1083608		12	1	St.	299,97
--	--	----	---	-----	---------------

Uponor S-Press Ersatzladegerät

 1083610	Mini2, UP110	72	1	St.	263,63
--	--------------	----	---	-----	---------------

Uponor S-Press Werkzeugkoffer UP110

 1083602		20	1	St.	166,05
--	--	----	---	-----	---------------

Werkzeuge

Art-Nr.	Dimension	LE	VE	ME	Preis/ME
---------	-----------	----	----	----	----------

Uponor S-Press Maschine EL o Pressbacken UP75



1007082		20	1	St.	1120,97
---------	--	----	---	-----	---------

Uponor S-Press Ersatzakku UP75



1006949		12	1	St.	184,75
---------	--	----	---	-----	--------

Uponor S-Press Ersatzladegerät Mini UP75



1006950		10	1	St.	174,35
---------	--	----	---	-----	--------

Uponor S-Press Werkzeugkoffer blau UP75



1084676		20	1	St.	194,10
---------	--	----	---	-----	--------

Uponor S-Press Pressbacken UPP1



1007083	14	280	1	St.	138,02
1007084	16	216	1	St.	138,02
1007086	20	-	1	St.	138,02
1007087	25	-	1	St.	138,02
1007088	32	-	1	St.	138,02

Uponor S-Press Pressbacken UPP1



1015768	40	108	1	St.	177,46
1015792	50	108	1	St.	184,75

Uponor S-Press Basispressbacke



1046545	63-110	-	1	St.	351,86
---------	--------	---	---	-----	--------

Uponor S-Press Pressschlinge



1046541	63	72	1	St.	586,43
1046542	75	72	1	St.	809,47
1046543	90	72	1	St.	1100,17
1046544	110	54	1	St.	1172,84

Art-Nr.	Dimension	LE	VE	ME	Preis/ME
---------	-----------	----	----	----	----------

Uponor S-Press Akkumaschine Mini² mit KSP0 Pressbacken



1083586	16/20/25/32	30	1	Set	1691,58
---------	-------------	----	---	-----	---------

Uponor S-Press Akkumaschine Mini² mit KSP0 Pressbacken



1083594	16/20/25	25	1	Set	1536,20
---------	----------	----	---	-----	---------

Uponor S-Press Akkumaschine Mini²



1087260		-	1	St.	819,84
---------	--	---	---	-----	--------

Uponor S-Press Ersatzakku Mini²



1083605		48	1	St.	251,18
---------	--	----	---	-----	--------

Uponor S-Press Ersatzladegerät



1083610	Mini2, UP110	72	1	St.	263,63
---------	--------------	----	---	-----	--------

Uponor S-Press Ersatzakku Mini



1015703		120	1	St.	185,80
---------	--	-----	---	-----	--------

Uponor S-Press Werkzeugkoffer Mini²



1083599		25	1	St.	88,23
---------	--	----	---	-----	-------

Uponor S-Press Pressbacken Mini KSP0



1007090	14	5	1	St.	160,87
1007091	16	5	1	St.	160,87
1007093	20	5	1	St.	160,87
1007094	25	5	1	St.	160,87
1007095	32	5	1	St.	160,87

Aufweiten

Art-Nr.	Dimension	LE	VE	ME	Preis/ME
---------	-----------	----	----	----	----------

Uponor Minitec Aufweitwerkzeug

 1006247	9,9x1,1	11	1	Set	298,91
--	---------	----	---	-----	---------------

Uponor Q&E Aufweitwerkzeug mit Aufweitk. M12

 1063112	6BAR 9,9/20	-	1	Set	505,48
1057166	16/20/25 6bar	-	1	Set	633,11

Uponor Q&E Aufweitkopf M12

 1060702	9,9x1,1	-	1	St.	113,13
--	---------	---	---	-----	---------------

Uponor Q&E Aufweitkopf M12/M18

 1057184	14/15x2,5	-	1	St.	117,26
1057172	16x1,8/2,0/2,2	-	1	St.	113,13
1057185	17/18x2,5	-	1	St.	113,13
1057173	20x1,9/2,0	-	1	St.	113,13
1057174	20x2,8	-	1	St.	113,13
1057175	25x2,3	-	1	St.	113,13
1057176	25x3,5	-	1	St.	113,13
1057177	32x2,9	-	1	St.	113,13

Uponor Q&E Ersatzakku für Aufweitwerkz. M12

 1061185	4Ah	12	1	St.	113,13
--	-----	----	---	-----	---------------

Art-Nr.	Dimension	LE	VE	ME	Preis/ME
---------	-----------	----	----	----	----------

Uponor Q&E Aufweitwerkzeug mit Aufweitk. M18 6bar

 1063908	16/20/25/32	-	1	Set	1032,62
--	-------------	---	---	-----	----------------

Uponor Q&E Aufweitwerkzeug mit Aufweitk. M18 10bar

 1063909	16/20/25/H32	-	1	Set	1079,32
--	--------------	---	---	-----	----------------

Uponor Q&E Aufweitkopf M18 H

 1057182	32x2,9/4,4	-	1	St.	125,59
1057183	40x3,7	-	1	St.	125,59

Uponor Q&E Aufweitwerkzeug M18 VLD PEX

 1085099	40-75	-	1	St.	2324,95
--	-------	---	---	-----	----------------

Uponor Q&E Aufweitkopf VLD

 1085095	40x3,7/5,5	-	1	St.	482,64
1085096	50x4,6/6,9	-	1	St.	506,51
1085097	63x5,8/8,6	-	1	St.	534,39
1085098	75x6,8/10,3	-	1	St.	555,26

Uponor Q&E Akku für Aufweitwerkzeug M18 PEX

 1085100	5,0Ah	-	1	St.	267,80
--	-------	---	---	-----	---------------

Uponor Q&E Ladegerät Aufweitwerkzeug M12/M18 PEX

 1085101	220-240V/50-60Hz	-	1	St.	124,94
--	------------------	---	---	-----	---------------

Uponor Q&E Grafitpaste

 1005017	100g	-	1	St.	22,63
--	------	---	---	-----	--------------

Befestigen

Art-Nr.	Dimension	LE	VE	ME	Preis/ME
---------	-----------	----	----	----	----------

Uponor Multi Rohrhalterung



1088066		-	1	St.	189,93
----------------	--	---	---	-----	---------------

Uponor Siccus 14 Schneidegerät



1006290	14mm 230V	20	1	St.	208,63
----------------	-----------	----	---	-----	---------------

Uponor Tacker-Werkzeug



NEU 1119039	14-20mm	50	1	St.	210,00
---------------------------	---------	----	---	-----	---------------

Uponor Tacker Tackergerät



OUT 1002295	14-20mm l=700mm	32	1	St.	285,42
---------------------------	-----------------	----	---	-----	---------------

OUT Lieferung solange Vorrat reicht.
Artikel läuft im Laufe des Jahres aus.

Art-Nr.	Dimension	LE	VE	ME	Preis/ME
---------	-----------	----	----	----	----------

Uponor Classic Clipmaster



1006295	16/17mm l=920mm	100	1	St.	148,42
1006309	20mm l=920mm	-	1	St.	255,34

Uponor Classic Ersatzteilerfeder



1007349		-	1	St.	7,51
----------------	--	---	---	-----	-------------

Uponor Classic Drillgerät f.Mattenbinder



1006243	l=320mm	50	1	St.	20,03
----------------	---------	----	---	-----	--------------

Uponor Multi Klebebandabroller



1000142		20	1	St.	23,67
----------------	--	----	---	-----	--------------

Uponor Rapex Press

Uponor Rapex Press-Backe



1006330	14x2	-	1	St.	173,32
1006332	16x2	8	1	St.	173,32
1006343	17x2	-	1	St.	173,32
1006334	20x2,3	-	1	St.	173,32
1006344	25x2,3	-	1	St.	173,32

Neu in der Preisliste 2021

Art.-Nr.	Artikel		Seite
----------	---------	--	-------

Installationssysteme

1118706	Uponor S-Press PLUS Schiebekupplung	16-16	9
1118707	Uponor S-Press PLUS Schiebekupplung	20-20	9
1118708	Uponor S-Press PLUS Schiebekupplung	25-25	9
1118709	Uponor S-Press PLUS Schiebekupplung	32-32	9
1118710	Uponor S-Press Schiebekupplung	40-40	9
1070705	Uponor S-Press PLUS Übergang auf Kupfer	16-10CU	13
1070706	Uponor S-Press PLUS Übergang auf Kupfer	16-12CU	13
1095818	Uponor RS Adapter	S-Press PLUS 20-RS2	17
1095820	Uponor RS Adapter	S-Press PLUS 32-RS2	17

Heizen Kühlen

1088166	Uponor Comfort Pipe PLUS Rohr	14x2,0 640m	23, 24, 30
1096010	Uponor MLCP RED Rohr	14x1,6 240m	23, 24, 27, 30, 34, 35
1096011	Uponor MLCP RED Rohr	14x1,6 480m	23, 24, 27, 30, 34, 35
1096014	Uponor Klett Rohr MLCP RED	16X2,0 240M	26
1096015	Uponor Klett Rohr MLCP RED	16X2,0 480M	26

Regelungstechnik

1000138	Uponor Vario PLUS Thermoantrieb	NC 24V MT30x1,5	40
1005605	Uponor Vario PLUS Thermoantrieb	NC 230V MT30x1,5	40
1007249	Uponor Vario B Stellantrieb	NC 24V FT28x1,5	57
1013006	Uponor Vario S Thermoantrieb Edelstahl.	NC 230V NC FT30x1,5	42
1013008	Uponor Vario S Thermoantrieb Edelstahl.	NC 24V NC FT30x1,5	42
1022244	Uponor Vario B Stellantrieb	NC 230V FT28x1,5	57
1095309	Uponor Fluvia Pumpe	Wilo Para SC 6m, 180mm	57
1119445	Uponor Fluvia Move Pumpengruppe	CPG-15-C-W	56
1119448	Uponor Fluvia Move Pumpengruppe	CPG-15-D-W	56
1119812	Uponor Fluvia Move PLUS Mischermotor	230V	55, 56
1119813	Uponor Fluvia Dreiwegemischer	CPG	56

Werkzeuge

1095265	Uponor Flex Rohrschneider	PEX 50-63	73
1095266	Uponor Flex Ersatzklinge für Rohrschneider	PEX 50+63	73
1119039	Uponor Tacker - Werkzeug	14-20mm	28, 77

Art.-Nr.	Artikel		Seite
----------	---------	--	-------

Nahwärmeversorgung

1095714	Uponor Ecoflex Thermo VIP	Single 40X3,7/140	62
1095715	Uponor Ecoflex Thermo VIP	Single 50X4,6/140	62
1095716	Uponor Ecoflex Thermo VIP	Single 63X5,8/140	62
1095717	Uponor Ecoflex Thermo VIP	Single 75X6,8/140	62
1095718	Uponor Ecoflex Thermo VIP	Single 90X8,2/175	62
1095719	Uponor Ecoflex Thermo VIP	Single 110X10,0/175	62
1095720	Uponor Ecoflex Thermo VIP	Single 125X11,4/200	62
1118580	Uponor Ecoflex Thermo VIP	Twin 2x25x2,3/140	62
1118581	Uponor Ecoflex Thermo VIP	Twin 2x32x2,9/140	62
1118582	Uponor Ecoflex Thermo VIP	Twin 2x40x3,7 /175	62
1118583	Uponor Ecoflex Thermo VIP	Twin 2x50x4,6/175	62
1118584	Uponor Ecoflex Thermo VIP	Twin 2x63x5,8/200	62
1118585	Uponor Ecoflex Thermo VIP	Twin 2x75x6,8/250	62
1119047	Uponor Ecoflex Aqua VIP	Single 40x5,5/140	64
1119048	Uponor Ecoflex Aqua VIP	Single 50x6,9/140	64
1119049	Uponor Ecoflex Aqua VIP	Single 63x8,6/140	64
1119053	Uponor Ecoflex Aqua VIP	Twin 25x3,5- 20x2,8/140	64
1119054	Uponor Ecoflex Aqua VIP	Twin 32x4,4- 20x2,8/140	64
1119055	Uponor Ecoflex Aqua VIP	Twin 40x5,5- 25x3,5/140	64
1119056	Uponor Ecoflex Aqua VIP	Twin 50x6,9- 32x4,4/175	64
1094013	Uponor Ecoflex Anschweißkupplung	ST PN6 EU+GOST 25x2,3-26,9	68
1094014	Uponor Ecoflex Anschweißkupplung	ST PN6 EU 32x2,9-33,7	68
1094015	Uponor Ecoflex Anschweißkupplung	ST PN6 EU 40x3,7-42,4	68
1094016	Uponor Ecoflex Anschweißkupplung	ST PN6 EU 50x4,6-48,3	68
1094017	Uponor Ecoflex Anschweißkupplung	ST PN6 EU 63x5,8-60,3	68
1094018	Uponor Ecoflex Anschweißkupplung	ST PN6 EU+GOST 75x6,8-76,1	68
1094019	Uponor Ecoflex Anschweißkupplung	ST PN6 EU+GOST 90x8,2-88,9	68
1094020	Uponor Ecoflex Anschweißkupplung	ST PN6 EU 110x10,0-114,3	68
1094021	Uponor Ecoflex Anschweißkupplung	ST PN6 EU+GOST 125x11,4-114,3	68
1119374	Uponor Ecoflex Gummi-Endkappe	Twin 18-22+25- 28+32/140	70
1095801	Uponor Ecoflex Gummi-Endkappe	Single 63+75+90/140	70
1105785	Uponor Ecoflex Trassenwarnband, rot	40mm x 30m	71
1118765	Uponor Ecoflex Hauseinführungsbogen	Single 50x4,6/140	70
1118766	Uponor Ecoflex Hauseinführungsbogen	Single 63x5,8/140	70
1118767	Uponor Ecoflex Hauseinführungsbogen	Single 75x6,8/140	70
1118771	Uponor Ecoflex Hauseinführungsbogen	Twin 2x25x2,3/140	71
1118772	Uponor Ecoflex Hauseinführungsbogen	Twin 2x32x2,9/140	71
1118773	Uponor Ecoflex Hauseinführungsbogen	Twin 2x40x3,7/160	71
1118774	Uponor Ecoflex Hauseinführungsbogen	Twin 2x50x4,6/200	71
1118775	Uponor Ecoflex Hauseinführungsbogen	Twin 2x63x5,8/200	71
1118776	Uponor Ecoflex Hauseinführungsbogen	Twin 2x75x6,8/250	71
1119057	Uponor Ecoflex Stationäre Abrollvorrichtung	< 600kg	73

Ersetzungen

Auslaufartikel → → Neue Artikel

Art.-Nr.: Solange Vorrat reicht, Artikel laufen aus:

Art.-Nr.: Neue Artikel

Seite

ALT			NEU		
1029121	Uponor RS Adapter	S-Press 25-RS2	1095819	Uponor RS Adapter	S-Press PLUS 25-RS2
1029122	Uponor RS Adapter	S-Press 32-RS2	1095820	Uponor RS Adapter	S-Press PLUS 32-RS2
1059396	Uponor RS Adapter	S-Press 20-RS2	1095818	Uponor RS Adapter	S-Press PLUS 20-RS2
1072009	Uponor Q&E T-Stück	CE PPSU 20-20-20	1008685	Uponor Q&E T-Stück	PPSU 20-20-20
1072030	Uponor Q&E T-Stück red. Übergang	CE PPSU 40-32-32	1008709	Uponor Q&E Reduzier-T-Stück	PPSU 40-32-32
1071659	Uponor Smatrix Wave Erweiterungsmodul	M-160 6X	1093133	Uponor Smatrix Wave Slave-Modul	Pulse M-262 6X 49
1071685	Uponor Smatrix Wave Regelmodul	X-165 6X	1093021	Uponor Smatrix Wave Regelmodul	Pulse X-265 6X 49
1071690	Uponor Smatrix Base Regelmodul	X-145 Bus 6X	1093017	Uponor Smatrix Base Regelmodul	Pulse X-245 BUS 6X 51
1078308	Uponor Fluvia Move Pumpengruppe	CPG-15-A-W	1119445	Uponor Fluvia Move Pumpengruppe	CPG-15-C-W 56
1087763	Uponor Vario Thermoantrieb	S 230V	1013006	Uponor Vario S Thermoantrieb Edelstahlv.	NC 230V NC FT30x1,5 42, 52
1087778	Uponor Vario Thermoantrieb	S 24V	1013008	Uponor Vario S Thermoantrieb Edelstahlv.	NC 24V NC FT30x1,5 42, 51, 54
1090262	Uponor Vario PLUS Thermoantrieb PRO	24V 1W NC VA02 MT 30x1,5	1000138	Uponor Vario PLUS Thermoantrieb	NC 24V MT30x1,5 40, 49, 51, 54
1090263	Uponor Vario PLUS Thermoantrieb PRO	230V 1W NC VA02 MT 30x1,5	1005605	Uponor Vario PLUS Thermoantrieb	NC 230V MT30x1,5 33, 40, 52, 54
1090264	Uponor Vario B Thermoantrieb PRO	24V 1W NC VA32 FT 28x1,5	1007249	Uponor Vario B Stellantrieb	NC 24V FT28x1,5 49, 51, 54
1090265	Uponor Vario B Thermoantrieb PRO	230V 1W NC VA32 FT 28x1,5	1022244	Uponor Vario B Stellantrieb	NC 230V FT28x1,5 52, 54
1000536	Uponor Wired 24V Raumfühler	T-37	1000535	Uponor Wired 24 V Raumfühler	T-35
1002295	Uponor Tackergerät	14-20mm l=700mm	1119039	Uponor Tacker-Werkzeug	14-20mm 28, 77
1005047	Uponor Classic Rohrhalter	17mm 3mm	1005189	Uponor Classic Rohrhalter	17mm 3mm 29
1001369	Uponor Flex Rohrschneider	PEX 14-25	1089673	Uponor Flex Rohrschneider	PEX 12-25
1036012	Uponor Ecoflex Schrumpfmanschette	68+90-650mm	1093120	Uponor Ecoflex Schrumpfband	160mm x 10m

Artikel laufen aus

Lieferung solange Vorrat reicht, Artikel laufen im Lauf des Jahres aus

Art.-Nr.: Artikel	Seite
<i>Artikelnummern aufsteigend</i>	
1000053 Uponor Multi Wärme-/Schalldämmung PRO 20-1mm 1000x500mm	
1000054 Uponor Multi Wärme-/Schalldämmung PRO 30-1mm 1000x500mm	
1000055 Uponor Multi Wärme-/Schalldämmung PRO 38-1mm 1000x500mm	
1000057 Uponor Multi Wärme-/Schalldämmung PRO 50-1mm 1000x625mm	
1000064 Uponor Multi Dämmplatte PUR 30mm	
1000065 Uponor Multi Dämmplatte PUR 40mm	
1000069 Uponor Multi Dämmplatte PUR 70mm	
1000128 Uponor Funk-Raumfühler weiß	
1000312 Uponor Space Taupunktfühler TF 3 PR 24V	52
1000313 Uponor Space Taupunktfühler TF 3 GM 24V	52
1000314 Uponor Space Schnittstellenkonverter TK 1PF 24V	52
1005091 Uponor SPI Vario Übergangsreduktion KPV COMP G1-1/2"	
1005096 Uponor SPI Vario Tauchhülse für Thermometer COMP	
1005097 Uponor SPI Vario Thermometer COMP 0-60Gr	
1005101 Uponor Vario Vorlaufventil-Handrad, weiß	43
1005102 Uponor Vario Rücklaufventil-Handrad, schwarz	43
1005106 Uponor SPI Vario Schutzkappe, weiß für Velta KPV COMP	
1005119 Uponor SPI Vario O-Ring COMP 30x3	
1005121 Uponor SPI Vario Flachdichtung COMP 30x24x4	
1005122 Uponor SPI Vario O-Ring COMP 18x2	
1005123 Uponor SPI Vario O-Ring COMP 16x2,5	
1005135 Uponor SPI Vario Kunststoff-Luftschraube weiss f. Kompaktverteiler COMP	
1005147 Uponor SPI Vario Kunststoffriegelverschluss	
1005148 Uponor SPI Vario Zylinderschloss m. 2 Schlüssel Combi	
1005226 Uponor Vario PLUS Endsegmentset	40
1005237 Uponor SPI Vario PLUS Handrad	
1005533 Uponor ETA Ventilintervallkarte VI-D 12 12V, Anschluss in Grundeinheit	
1005536 Uponor ETA Pumpenkarte PK-D 12 12V, Anschluss in Grundeinheit	
1005549 Uponor SPI Viva Dreiwegeventil VMV 25	
1005558 Uponor Veltamat 2d/3d abv-no 230V	
1005568 UPONOR Kühlkarte 3D-K	
1005625 Uponor ETA Velta Genius Regelmodul für Velta Genius Basiseinheit	
1006284 Uponor SPI Vario Kompaktverteiler Werkzeug COMP	
1006631 Uponor SPI Vario Ventil Einsatz Vorlauf A	
1007039 Uponor SPI Vario KR-Rücklaufventileinsatz f. KPV COMP	
1007050 Uponor SPI Tacker Ersatzfeder für Profi-Tacker	
1007234 Uponor Klett Platte EPS DEO 15mm 2x1m	25
1007369 Uponor Ecoflex Faserzementrohr DWD 90	
1012993 Uponor SPI Vario Thermostatventil	
1013003 Uponor SPI Vario Ventileinsatz für Profi-Edelstahlverteiler	
1013244 Uponor S-Press Fühlerelement Aquastrom T plus PT 100	
1034433 Uponor Fluvia Ventil, Push 12 M30 Push-12 M30	
1042389 Uponor Q&E Ring mit Fixieranschlag natural, eval 16	
1042837 Uponor Q&E Ring mit Fixieranschlag natural, eval 20	
1042841 Uponor Q&E Ring mit Fixieranschlag natural, eval 25	
1042923 Uponor SPI S-Press Anschlagringsegment 40	
1042924 Uponor SPI S-Press Anschlagringsegment 50	
1042925 Uponor SPI S-Press Anschlagringsegment 63	
1045562 Uponor Radio 24V Basiseinheit mit DEM C-56+I-76 CE/EEI	
1046556 Uponor Vario Tür für Verteilerschrank UP1	44
1046557 Uponor Vario Tür für Verteilerschrank UP2	44
1046558 Uponor Vario Tür für Verteilerschrank UP3	44
1046559 Uponor Vario Tür für Verteilerschrank UP4	
1046560 Uponor Vario Rahmen für Verteilerschrank UP1	44
1046561 Uponor Vario Rahmen für Verteilerschrank UP2	44
1046562 Uponor Vario Rahmen für Verteilerschrank UP3	44
1046563 Uponor Vario Rahmen für Verteilerschrank UP4	
1046883 Uponor Vario PLUS Wandhalterset 225-35-50	40

Art.-Nr.: Artikel	Seite
1047196 Uponor Q&E Kupplung PL 32-32	
1047200 Uponor Q&E Winkel PL 32-32	
1047210 Uponor Q&E Kupplung reduziert PL 20-16	
1047611 Uponor Radi Pipe natur PN6 16x2,0 240m	
1047613 Uponor Comfort Pipe Rohr 20x2,0 303m	
1047845 Uponor Radio 24V Heizen/Kühlen Regler C-46	
1047870 Uponor Q&E Kupplung reduziert PL 25-20	
1048762 Uponor Smatrix Move PRO Netzteil A-15X 230V/24V	
1057359 Uponor Rapex Abdrückstopfen PREFAB 14x2,0	
1058342 Uponor Magna Verteiler Bajonett Verschraubung 40mm	
1058427 Uponor Base Pumpenrelais X-23 230V	52
1058429 Uponor Q&E Ring natural, eval 17	
1059841 Uponor Fluvia Exenter-Fitting G11/2xG1	
1060344 Uponor Smart Aqua U-Armaturenanschluss Q&E R1/2"MT-16-16	
1060367 Uponor Smart Aqua Schallset 1 U-Wandsch.	11
1061526 Uponor SPI Fluvia Winkelverschraubung PUSH-23-2, Push-23	
1062221 Uponor Smart Aqua U-Armaturenanschluss RTM mixer 16-16-R1/2"MT	
1063930 Uponor Q&E T-Stück Übergang S-Press 40-Q&E20-Press40	
1063931 Uponor Q&E Übergang S-Press 40-Q&E20	
1067394 Uponor Fluvia T Dämmschale Push-12	57
1071646 Uponor Smatrix Wave Bedienmodul I-167	49
1071652 Uponor Smatrix Wave Regelmodul Set X-165+I-167 6X	
1072021 Uponor Q&E Kupplung reduziert CE PPSU 32-25	
1072029 Uponor Q&E T-Stück red. Übergang CE PPSU 40-25-40	
1084142 Uponor Ecoflex Rohr-Rundungswerkzeug 125	
1084570 Uponor Nubos Noppenfolie 14-16mm	24
1084690 Uponor Smatrix Wave Smart Home Modul gateway R-167	
1085957 Uponor Vario M Rücklaufventil	41
1085958 Uponor Vario M Thermometer	41
1085959 Uponor Vario M Sicherheitsbügel Set 3x2	41
1086273 Uponor Smatrix Aqua PLUS Spülstation S-Press 16-16	
1086274 Uponor Smatrix Aqua PLUS Spülstation S-Press 16-20	
1086275 Uponor Smatrix Aqua PLUS Spülstation S-Press 20-20	
1086276 Uponor Smatrix Aqua PLUS Spülstation S-Press 16	
1086277 Uponor Smatrix Aqua PLUS Spülstation S-Press 20	
1086285 Uponor Smatrix Aqua PLUS Fliesenrahmen	
1086286 Uponor Smatrix Aqua PLUS Wandabdeckung M	
1086665 Uponor Fluvia Move 2-Wege-Stellantrieb Push-23-A-AC 230V	56
1087424 Uponor Smatrix Aqua PLUS Inbetriebnahme1	
1087426 Uponor Smatrix Aqua PLUS Inbetriebnahme3	
1087427 Uponor Smatrix Aqua PLUS Wartung 1	
1087470 Uponor Smatrix Aqua PLUS Wandabdeckung S	
1088056 Uponor Vario S Verteiler Kappenventil LS	42
1089056 Uponor S-Press Übergang auf Edelstahl SST 16-15SST	13
1089057 Uponor S-Press Übergang auf Edelstahl SST 20-22SST	13
1089058 Uponor S-Press Übergang auf Edelstahl SST 25-22SST	13
1089059 Uponor S-Press Übergang auf Edelstahl SST 32-28SST	13
1090919 Uponor Tacker Panel EPS DEO 50mm	27
1090922 Uponor Tacker Rolle EPS DES 25-2mm 10x1m	27
1093554 Uponor Vario Zylinderschloss 2 Schlüssel	44
1094025 Uponor Comfort Port vertikal links IG Vario S FM X-24 6X 230V 740x610x110	
1094026 Uponor Comfort Port vertikal links IG Vario S FM X-24 7X 230V 740x760x110	
1094027 Uponor Comfort Port vertikal links IG Vario S FM X-24 8X 230V 740x760x110	
1094028 Uponor Comfort Port vertikal links IG Vario S FM X-24 9X 230V 740x760x110	
1094029 Uponor Comfort Port vertikal links IG Vario S FM X-24 10X 230V 740x910x110	

Allgemeine Liefer- und Zahlungsbedingungen der Uponor GmbH

1. Allgemeines

- 1.1 Unsere Lieferungen und Leistungen erfolgen ausschließlich aufgrund der nachstehenden Bedingungen. Abweichungen haben nur dann Gültigkeit, wenn sie schriftlich von uns bestätigt werden.
- 1.2 Mit der Erteilung des Auftrages, spätestens mit der Entgegennahme der Ware erkennt der Käufer unsere Allgemeinen Liefer- und Zahlungsbedingungen an. Abweichende Bedingungen des Käufers, die wir nicht ausdrücklich schriftlich anerkennen, sind für uns unverbindlich, auch wenn wir ihnen nicht ausdrücklich widersprechen.
- 1.3 Diese Bedingungen gelten auch für zukünftige Lieferungen aufgrund schriftlicher oder fernmündlicher Bestellungen des Käufers.
- 1.4 Alle Bestellungen, Aufträge und Vereinbarungen werden für uns erst mit Zugang unserer schriftlichen Auftragsbestätigung beim Käufer oder, falls eine Auftragsbestätigung nicht erteilt wird, mit Lieferung der Ware verbindlich. Mündliche oder telefonische Zusagen oder sonstige Abreden einschließlich etwaiger Ergänzungen, Abänderungen und Nebenabreden zu bereits angenommenen Bestellungen sowie durch unsere Vertreter getätigte Verkäufe sind für uns erst verbindlich, sobald und soweit sie von uns nachträglich schriftlich bestätigt sind.
- 1.5 Für Maschinen und Werkzeugverkäufe gelten ergänzend unsere diesbezüglichen Zusatzbedingungen.

2. Preise und Lieferung

- 2.1 Unsere Listen- und Angebotspreise sind freibleibend und unverbindlich, sofern nicht eine bestimmte Geltungsdauer schriftlich vereinbart ist. Alle Preise verstehen sich in EURO ab Werk ohne Verpackung, Verladung, Fracht und Montage zuzüglich der jeweils geltenden Mehrwertsteuer. Bei einer Direkt-/ Streckenlieferung mit einem Warenbestellwert unter 500 € netto wird ein Mindermengenzuschlag von 20 € zzgl. gesetzlicher Mehrwertsteuer pro Lieferung berechnet. Bei Lieferungen an das Lager des Käufers erfolgt die Lieferung grundsätzlich in vollständigen Verpackungseinheiten gemäß der aktuellen Preisliste. Müssen wir für die Bearbeitung einer Bestellung eine oder mehrere Verpackungseinheiten anbrechen, weil der Käufer lediglich eine anteilige Verpackungseinheit eines oder mehrerer Artikel bestellt hat, werden dem Käufer für diesen Mehraufwand pro Bestellung pauschal 20 € zzgl. gesetzlicher Mehrwertsteuer zusätzlich berechnet.
- 2.2 Unabhängig davon, ob eine Versendung ab Werk erfolgt und wer die Frachtkosten trägt, hat der Käufer alle Gefahren des Verlustes oder der Beschädigung der Ware von dem Zeitpunkt an zu tragen, zu dem ihm die Ware – ohne Verladung auf das abholende Beförderungsmittel – ab Werk zur Verfügung gestellt wurde.
- 2.3 Etwa notwendige Verpackung wird zum Selbstkostenpreis berechnet und nicht zurückgenommen.
- 2.4 Alle Liefertermine und Fristen gelten nur als annähernd, sofern sie nicht schriftlich ausdrücklich als verbindlich zugesagt werden. Wünscht der Käufer Lieferung zu einem späteren als dem ursprünglich vereinbarten Termin, können wir die Vertragsleistung zum vereinbarten Liefertermin in Rechnung stellen und die Ware auf Kosten des Käufers einlagern. Erfolgt eine Lagerung in unserem Werk, sind wir berechtigt, ein Lagergeld in Höhe von 2,5‰ des Auftragsnettowerts für jeden angefangenen Monat der Lagerung zu verlangen.
- 2.5 Teillieferungen sind zulässig.
- 2.6 Bestellt der Käufer Ware auf Abruf, so gilt der Abruf spätestens sechs Monate nach der Bestellung als erfolgt, es sei denn, es ist schriftlich eine andere Vereinbarung getroffen worden.
- 2.7 Betriebsstörungen, Kriegszustand, Arbeitskämpfe oder sonstige Ereignisse höherer Gewalt bei uns oder unseren Lieferanten berechtigen uns, die Lieferung um die betreffende Zeitdauer hinauszuschieben. Wir werden dem Käufer solche Hindernisse unverzüglich mitteilen. Erhöhen sich infolge derartiger unvorhergesehener Umstände unsere Kosten, so sind wir zu entsprechenden Preiskorrekturen berechtigt, insbesondere zur Berechnung der Tagespreise am Versandtag.

- 2.8 Begründete Zweifel an der Kreditwürdigkeit des Käufers berechtigen uns, vom Käufer für unsere Lieferungen Sicherheit oder Vorkasse zu verlangen oder vom Vertrag zurückzutreten. Schadensersatzansprüche des Käufers sind in diesen Fällen ausgeschlossen.

3. Zahlungsbedingungen

- 3.1 Zahlungstermine und Zahlungsfristen werden gesondert vereinbart. Bei Zielüberschreitungen werden bankübliche Zinsen, mindestens aber die gesetzlichen Verzugszinsen berechnet.
- 3.2 Die Annahme von Wechseln und Schecks erfolgt stets zahlungshalber; erst die Einlösung gilt als Zahlung. Die Annahme von Wechseln bedarf der gesonderten Vereinbarung. Diskontspesen und Kosten gehen zu Lasten des Kunden.
- 3.3 Unsere Angestellten, Vertreter oder Vertriebspartner sind nicht zur Entgegennahme von Zahlungen für uns berechtigt. Ausnahmen bedürfen unserer ausdrücklichen schriftlichen Einwilligung.
- 3.4 Mit von uns nicht anerkannten oder nicht rechtskräftig festgestellten Gegenansprüchen kann der Käufer weder aufrechnen noch wegen dieser Ansprüche ein Zurückbehaltungsrecht geltend machen.
- 3.5 Hält der Käufer die Zahlungsbedingungen nicht ein oder treten berechtigte Zweifel an der Kreditwürdigkeit des Käufers auf, so werden alle unsere Forderungen aus der gesamten Lieferbeziehung zum Käufer sofort fällig.

4. Eigentumsvorbehalt

- 4.1 Die gelieferten Waren bleiben bis zur vollständigen Bezahlung sämtlicher Lieferungen nebst allen Nebenforderungen aus der gesamten Geschäftsbeziehung einschließlich der Einlösung etwa von uns in Zahlung genommener Schecks oder Wechsel unser Eigentum. Unsere Forderungen gehen nicht durch Aufnahme in einen kontokorrentmäßigen Saldo und dessen Anerkennung unter.
- 4.2 Der Käufer hat die Vorbehaltsware ausreichend zu kennzeichnen und sie angemessen gegen Feuer und Einbruch-Diebstahl zu versichern.
- 4.3 Eine etwaige Be- oder Verarbeitung der Vorbehaltsware nimmt der Käufer für uns vor, ohne dass uns daraus Verpflichtungen entstehen. Bei Verarbeitung oder Verbindung der Vorbehaltsware mit anderen, nicht uns gehörenden Waren steht uns das dabei entstehende Miteigentum an der neuen Sache zu, und zwar im Verhältnis des Wertes der Vorbehaltsware zu der übrigen verarbeiteten Ware im Zeitpunkt der Verarbeitung oder Verbindung. Erwirbt der Käufer das Alleineigentum an der neuen Sache, so räumt er uns im Verhältnis des Wertes der verarbeiteten bzw. verbundenen Vorbehaltsware zum Gesamtwert der neuen Sache Miteigentum an der neuen Sache ein und verwahrt sie unentgeltlich für uns.
- 4.4 Der Käufer ist zur Weiterveräußerung der Vorbehaltsware im normalen Geschäftsverkehr berechtigt. Eine Verpfändung, Sicherungsübereignung oder ein Verleih ist ihm jedoch nicht gestattet. Veräußert der Käufer Vorbehaltsware weiter, so tritt er uns bereits jetzt seine künftigen Forderungen aus der Weiterveräußerung gegen seine Kunden mit allen Nebenrechten – einschließlich etwaiger Saldoforderungen – sicherungshalber ab, ohne dass es noch späterer besonderer Erklärungen bedarf. Wir nehmen die Abtretung an.
- 4.5 Wird die Vorbehaltsware von dem Käufer mit Grundstücken verbunden, so tritt der Käufer schon jetzt die daraus entstehende Forderung auf Vergütung in Höhe des Wertes der Vorbehaltsware mit allen Nebenrechten einschließlich des Rechts auf Einräumung einer Sicherungshypothek ab. Die Abtretung hat Vorrang vor sonstigen dem Käufer gegenüber seinem Kunden etwa zustehenden Ansprüchen. Wir nehmen die Abtretung an.
- 4.6 Wird die Vorbehaltsware zusammen mit anderen Waren – gleich ob ohne oder nach Verarbeitung oder Verbindung – weiterveräußert, so tritt der Käufer seine Forderungen aus der Weiterveräußerung der Vorbehaltsware ebenfalls an uns ab, jedoch nur in Höhe des Wertes der Vorbehaltsware, die zusammen mit den anderen Waren Gegenstand des Verkaufs ist. Entsprechendes gilt für etwaige Saldoforderungen. Wir nehmen die Abtretung an.

- 4.7 Bis auf Widerruf ist der Käufer zur Einziehung der abgetretenen Forderungen befugt. Wir sind zum Widerruf dieser Einziehungsbefugnis berechtigt, wenn der Käufer seinen Verpflichtungen uns gegenüber nicht nachkommt oder sonstige wichtige Gründe vorliegen, insbesondere Zahlungseinstellung, Eröffnung eines Insolvenzverfahrens, Wechselprotest oder vergleichbare Anhaltspunkte, die eine Zahlungsunfähigkeit des Käufers nahelegen. Im Falle des Widerrufs hat der Käufer uns die zur Einziehung unserer Forderungen erforderlichen Angaben über die abgetretenen Forderungen zu machen und den Schuldnern die Abtretung mitzuteilen.
- 4.8 Übersteigt der realisierbare Wert der uns nach Maßgabe der vorstehenden Ziffern zur Verfügung gestellten Sicherheiten die zu sichernden Forderungen aus der gesamten Geschäftsbeziehung um mehr als 20 %, sind wir auf Verlangen des Käufers insoweit zur Freigabe von Sicherheiten nach eigener Wahl verpflichtet.
- 4.9 Über das etwaige Abhandenkommen sowie die Beschädigung oder Zerstörung von Vorbehaltsware hat uns der Käufer unverzüglich zu unterrichten. Dasselbe gilt für Zwangsvollstreckungsmaßnahmen Dritter in die Vorbehaltsware oder in die abgetretenen Forderungen. Der Käufer hat uns alle Informationen zur Verfügung zu stellen, die wir benötigen, um unsere Rechte Dritten gegenüber geltend zu machen.
- 4.10 Die Geltendmachung von Eigentumsvorbehaltsrechten durch uns gilt nicht als Rücktritt vom Vertrag.
5. Haftung für Mängel
- 5.1 Die in dieser Produktinformation oder sonstigen Prospekten, Werbematerialien, Beschreibungen usw. enthaltenen Angaben beruhen auf dem aktuellen Stand unserer Erkenntnisse und Erfahrungen. Anwendung, Verwendung und Verarbeitung erfolgen außerhalb unserer Kontrollmöglichkeiten. Alle Angaben sind deswegen nur als ungefähre Angaben und nicht als Beschaffenheitsangaben anzusehen. Sie begründen keine Beschaffenheits- oder Haltbarkeitsgarantie. Die Eignung unserer Produkte für den vorgesehenen Anwendungszweck ist durch den Käufer zu prüfen.
- 5.2 Der Käufer hat gelieferte Ware unverzüglich zu untersuchen. Offenkundige Mängel sind uns spätestens innerhalb von acht Tagen nach Empfang der Ware schriftlich mitzuteilen, andere Mängel unverzüglich nach ihrem Auftreten. Unsere Haftung für Mängel, die nicht rechtzeitig angezeigt worden sind, ist ausgeschlossen.
- 5.3 Nimmt der Käufer mangelhafte Ware an, obwohl er den Mangel kennt oder infolge grober Fahrlässigkeit nicht kennt, so stehen ihm Ansprüche und Rechte wegen dieser Mängel nur zu, wenn er sich diese bei der Annahme vorbehalten hat. Bei begründeten Beanstandungen bessern wir nach unserer Wahl die mangelhaften Liefergegenstände nach oder liefern Ersatz. Aus- und Einbaukosten sowie sonstige mit der Nacherfüllung verbundenen Kosten, insbesondere Transport-, Wege-, Arbeits- und Materialkosten, übernehmen wir nicht, wenn und soweit solche Kosten dadurch entstanden sind oder sich erhöht haben, daß der Besteller den Liefergegenstand eingebaut oder sonst verarbeitet hat, obwohl Mängel erkennbar waren.
- 5.4 Ansprüche wegen Mängel der Sache bestehen nicht bei nur unerheblicher Abweichung des Liefergegenstandes von der vereinbarten Beschaffenheit, einer unerheblichen Beeinträchtigung der Brauchbarkeit, im Falle natürlicher Abnutzung, Beschädigung durch Gewalt, durch unsachgemäße Behandlung oder Verwendung, übermäßige Beanspruchung, elementare Einflüsse oder im Falle eigenmächtiger, selbst vorgenommener oder bei Dritten veranlaßter Eingriffe des Käufers an der Ware.
- 5.5 Alle Ansprüche wegen Mängel der Sache verjähren in zwölf Monaten ab Lieferung. Abweichend davon gilt für Mängel an Liefergegenständen, die entsprechend ihrer üblichen Verwendungsweise für ein Bauwerk verwendet worden sind und dessen Mangelhaftigkeit verursacht haben, die gesetzliche Verjährungsfrist.
- 5.6 Für Schadensersatz wegen Mängel der Sache haften wir ausschließlich im Rahmen der nachstehenden Ziffer 6.
- 5.7 Ansprüche des Käufers aus weitergehenden Erklärungen, die wir ausdrücklich und schriftlich im Zusammenhang mit Lieferungen abgegeben haben, bleiben von den vorstehenden Bestimmungen unberührt.
6. Haftung für Schadensersatzansprüche
- 6.1 Wir haften nicht für Verzögerungsschäden und für Schäden, die auf einer leicht fahrlässigen Pflichtverletzung oder Handlung beruhen. Dies gilt nicht, wenn die Pflichtverletzung oder Handlung zu einer Verletzung des Lebens, des Körpers oder der Gesundheit führt oder in der Verletzung wesentlicher vertraglicher Pflichten besteht.
- 6.2 Wir haften nicht für leicht fahrlässiges Handeln unserer Organe und/oder leitender Angestellter und nicht für leicht und/oder grob fahrlässiges Handeln nicht leitender Angestellter, sofern keine den Vertragszweck gefährdenden wesentlichen Pflichten verletzt werden und die Pflichtverletzung nicht zu einer Verletzung des Lebens, des Körpers oder der Gesundheit führt.
- 6.3 Unsere Haftung ist in allen Fällen begrenzt auf die bei Vertragsabschluss vorhersehbaren, typischen Schäden, die aus der Pflichtverletzung oder Handlung resultieren.
- 6.4 Mit der vorstehenden Regelung ist eine Änderung der Beweislast zum Nachteil des Käufers nicht verbunden.
- 6.5 Ansprüche des Käufers aus sonstigen Erklärungen, die wir ausdrücklich und schriftlich im Zusammenhang mit Lieferungen abgegeben haben, sowie zwingende gesetzliche Ansprüche des Käufers, insbesondere nach Maßgabe des Produkthaftungsgesetzes, bleiben unberührt.
7. Gerichtsstand
- Gerichtsstand ist für beide Teile Haßfurt, sofern der Käufer Kaufmann, juristische Person des öffentlichen Rechts oder öffentlich-rechtliches Sondervermögen ist. Das gilt auch für Scheck- und Wechselprozesse. Wir sind darüber hinaus berechtigt, den Käufer an seinem allgemeinen Gerichtsstand zu verklagen.
8. Schlussbestimmungen
- 8.1 Es gilt ausschließlich deutsches Recht mit Ausnahme der Regeln über das internationale Privatrecht und des UN-Abkommens über den internationalen Warenkauf (CISG).
- 8.2 Wir sind berechtigt, die uns im Rahmen der Geschäftsbeziehung oder im Zusammenhang mit ihr zugänglich gemachten Daten über den Käufer im Sinne des Bundesdatenschutzgesetzes zu verarbeiten.
- 8.3 Falls einzelne Bestimmungen dieser Allgemeinen Liefer- und Zahlungsbedingungen unwirksam sind oder werden sollten, wird die Wirksamkeit der übrigen Bestimmungen dadurch nicht berührt.
- 8.4 Durch diese Allgemeinen Liefer- und Zahlungsbedingungen werden alle früher geltenden Geschäftsbedingungen aufgehoben und ersetzt.

Moving ➤ Forward

Auszug aus dem umfangreichen Programm als Kurzpreisliste Deutschland 2021.
Das vollständige Uponor Portfolio ist online als Gesamtpreisliste verfügbar.

Technische Hotline 0800 7780030

Kostenfrei aus dem deutschen Festnetz, Mobil- und Auslandsverbindungen abweichend.

uponor

Uponor GmbH
Industriestraße 56
97437 Haßfurt

T +49 (0)9521 690-0
F +49 (0)9521 690-710
E info.de@uponor.com