

**Trinkwasserinstallation  
Flächenheizung/-kühlung  
Nahwärmeversorgung**

**uponor**

**Kurzpreisliste 2023  
Deutschland**

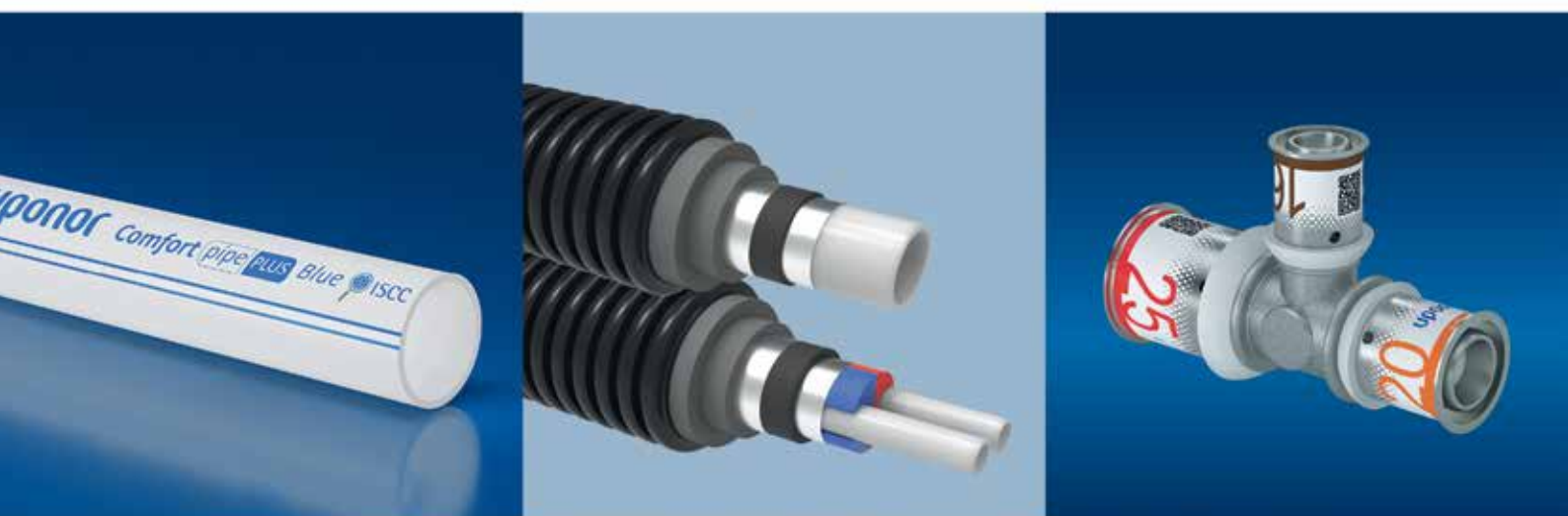

# Kurzpreisliste Deutschland 2023

## Installationssysteme

### Verbundrohre und Fittingsysteme

Uponor Uni Pipe PLUS.....	6
Uponor S-Press PLUS PPSU.....	7
Uponor S-Press PLUS 14 mm.....	8
Uponor S-Press PLUS.....	9
Uponor S-Press PLUS Systemübergänge.....	13
S-Press PLUS Ventile.....	14
Uponor S-Press PLUS Heizung.....	15
Uponor RS.....	16

## Heizen/Kühlen

### Systeme zur Flächenheizung/-kühlung über Boden, Wand und Decke

Übersicht Uponor Flächenheizungssysteme.....	18
Übersicht Uponor Heizrohre.....	20
Uponor Minitec.....	22
Uponor Tecto.....	23
Uponor Nubos.....	24
Uponor Klett.....	25
Uponor Tacker.....	27
Uponor Fix.....	28
Uponor Classic.....	30
Uponor Siccus 14.....	31
Uponor Renovis.....	32
Uponor Comfort E.....	33
Uponor Siccus wall.....	34
Uponor Thermatop Deckensystem.....	35
Uponor Multi – Zubehör Fußbodenaufbau.....	36
Verteil- und Steigleitungen > 20 mm.....	37

### Heizkreisverteiler und -zubehör

Übersicht Uponor Stellantriebe.....	38
Uponor Vario PLUS.....	39
Uponor Vario M.....	40
Uponor Vario S.....	41
Uponor Vario.....	43

### Regelungstechnik

Übersicht Regelungstechnik Uponor Smatrix.....	44
--	----

### Vorlauftemperaturregelung

Uponor Smatrix Move PRO.....	46
Uponor Smatrix Move.....	46
Uponor Fluvia Pumpengruppen.....	47

### Raumtemperaturregelung

Uponor Smatrix Wave / Pulse.....	49
Uponor Smatrix Base / Pulse.....	50
Uponor Smatrix Base PRO.....	51
Uponor Base.....	52
Uponor Space.....	53

## Nahwärmeversorgung

Übersicht Uponor Ecoflex Nahwärmeversorgung.....	54
Flexible, vorgedämmte Rohrsysteme.....	58

### Uponor Ecoflex Verbindungstechnik und -zubehör

Uponor Wipex.....	61
Uponor Q&E.....	63
Uponor Ecoflex Systemzubehör.....	64

Uponor Ecoflex Mietwerkzeuge.....	66
-----------------------------------	----

## Uponor Werkzeuge

Werkzeuge.....	67
----------------	----

## Anhang

Allgemeine Liefer- und Zahlungsbedingungen der Uponor GmbH.....	73
---	----

# Kurzpreisliste Deutschland 2023

## Installationssysteme

Trinkwasser- und Heizungsinstallation Uponor Verbundrohrsysteme . . . . .	6
--	---

Installation

## Flächenheizung/-kühlung

Flächenheizung/-kühlung über Boden, Wand und Decke . . . . .	18
Verteiler und -zubehör . . . . .	38
Raumtemperaturregelung . . . . .	44
Vorlauftemperaturregelung / Pumpengruppen . . . . .	46

Flächenheizung  
und -kühlung

## Nahwärmeversorgung

Flexible vorgedämmte Rohrleitungen und Verbindungstechniken für erdverlegte Nahwärmenetze . . . . .	54
--	----

Nahwärme-  
versorgung

## Werkzeuge

Werkzeuge für die Verarbeitung von Installationsrohren und Rohren in der Flächenheizung/-kühlung . . . . .	67
---	----

Werkzeuge

## Anhang

Allgemeine Geschäftsbedingungen . . . . .	73
---	----

Anhang

# Installationsrohre und Verbindungstechnik

Unterschiedliche Montagesituationen und Einsatzbereiche verlangen nach perfekt darauf abgestimmten Fittingkonzepten. Deshalb entwickelt und produziert Uponor nicht nur Rohre, sondern gleichzeitig auch die passenden, auf den jeweiligen Einsatz zugeschnittenen Fittingsysteme. Das Uponor Fittingprogramm mit Kupplungen, Winkeln, T-Stücken und einer Vielzahl von praxisingerechten Systemkomponenten schafft die Voraussetzung für eine schnelle, sichere und praxisingerechte Montage und übertrifft dabei die Anforderungen, die an hygienische Trinkwasser-Installationen und zeitgemäße Heizungsverrohrungen gestellt werden.

## Uponor Fittingsystem

Dimension/ Farbcode	Verbund- rohrtyp
 14	MLC
 16	Uni Pipe PLUS
 20	Uni Pipe PLUS
 25	Uni Pipe PLUS
 32	Uni Pipe PLUS
 40	MLC
 50	MLC
 63	MLC
 75	MLC
 90	MLC
 110	MLC

## Eigenschaften

Dimensionsabhängige Farbcodierung

Sichtfenster zur Kontrolle der Einstecktiefe

Verpresstkennzeichnung  
durch Ablösen der Folie von der Presshülse

Verpresstkennzeichnung  
durch Ablösung des Anschlagringes

Verpresstkennzeichnung  
durch Pressabdruck auf Presshülse

Montage ohne Entgraten

Montage ohne Kalibrieren

Verbinder unverpresst undicht

Integrierte Pressfunktion

Modulares Fittingsystem



# Uponor Uni Pipe PLUS

Art-Nr.	Dimension	LE	VE	ME RG	Preis/ME
 <b>1060783</b>	16x2,0	75	3	$\frac{m}{E1}$	<b>8,15</b>
<b>1059572</b>	16x2,0	125	5	$\frac{m}{E1}$	<b>7,75</b>
<b>1060784</b>	20x2,25	51	3	$\frac{m}{E1}$	<b>10,52</b>
<b>1059573</b>	20x2,25	85	5	$\frac{m}{E1}$	<b>10,02</b>
<b>1060785</b>	25x2,5	30	3	$\frac{m}{E1}$	<b>15,36</b>
<b>1059574</b>	25x2,5	50	5	$\frac{m}{E1}$	<b>14,81</b>
<b>1060786</b>	32x3,0	21	3	$\frac{m}{E1}$	<b>21,98</b>
<b>1059575</b>	32x3,0	35	5	$\frac{m}{E1}$	<b>21,03</b>

## Uponor MLC Rohr weiß S

 <b>1013448</b>	40x4,0	12	3	$\frac{m}{E1}$	<b>40,93</b>
<b>1013446</b>	40x4,0	20	5	$\frac{m}{E1}$	<b>40,22</b>
<b>1021980</b>	50x4,5	12	3	$\frac{m}{E1}$	<b>58,04</b>
<b>1013449</b>	50x4,5	20	5	$\frac{m}{E1}$	<b>57,41</b>
<b>1021981</b>	63x6,0	9	3	$\frac{m}{E1}$	<b>73,61</b>
<b>1013451</b>	63x6,0	15	5	$\frac{m}{E1}$	<b>71,85</b>
<b>1013453</b>	75x7,5	255	5	$\frac{m}{E1}$	<b>116,29</b>
<b>1013455</b>	90x8,5	255	5	$\frac{m}{E1}$	<b>126,69</b>
<b>1013457</b>	110x10,0	165	5	$\frac{m}{E1}$	<b>150,85</b>

## Uponor Uni Pipe PLUS weiß

 <b>1059576</b>	16x2,0	2000	100	$\frac{m}{E1}$	<b>3,93</b>
<b>1092653</b>	16x2,0	2400	120	$\frac{m}{E1}$	<b>3,93</b>
<b>1059577</b>	16x2,0	2600	200	$\frac{m}{E1}$	<b>3,93</b>
<b>1059578</b>	16x2,0	3500	500	$\frac{m}{E1}$	<b>3,93</b>
<b>1059579</b>	20x2,25	1300	100	$\frac{m}{E1}$	<b>7,03</b>
<b>1093124</b>	20x2,25	2000	500	$\frac{m}{E1}$	<b>7,03</b>
<b>1059581</b>	25x2,5	700	50	$\frac{m}{E1}$	<b>14,59</b>
<b>1059583</b>	32x3,0	400	50	$\frac{m}{E1}$	<b>20,54</b>

## Uponor MLC Rohr weiß

 <b>1013366</b>	14x2,0 200m	2600	200	$\frac{m}{E1}$	<b>4,10</b>
--	-------------	------	-----	----------------	-------------

## Uponor Uni Pipe PLUS weiß vorgedämmt S4 WLS 040

 <b>1091709</b>	16x2,0 rot	800	100	$\frac{m}{E1}$	<b>7,03</b>
<b>1063553</b>	16x2,0 blau	800	100	$\frac{m}{E1}$	<b>7,03</b>
<b>1091710</b>	20x2,25 rot	800	100	$\frac{m}{E1}$	<b>9,37</b>
<b>1063555</b>	20x2,25 blau	800	100	$\frac{m}{E1}$	<b>9,37</b>
<b>1091711</b>	25x2,5 rot	400	50	$\frac{m}{E1}$	<b>23,08</b>
<b>1063946</b>	25x2,5 blau	400	50	$\frac{m}{E1}$	<b>23,08</b>
<b>1091712</b>	32x3,0 rot	350	50	$\frac{m}{E1}$	<b>31,74</b>
<b>1091716</b>	32x3,0 blau	350	50	$\frac{m}{E1}$	<b>31,74</b>

Art-Nr.	Dimension	LE	VE	ME RG	Preis/ME
 <b>1063556</b>	16x2,0 blau	600	75	$\frac{m}{E1}$	<b>7,37</b>
<b>1063557</b>	20x2,25 blau	600	75	$\frac{m}{E1}$	<b>9,11</b>
<b>1063558</b>	25x2,5 blau	400	50	$\frac{m}{E1}$	<b>21,57</b>

## Uponor Uni Pipe PLUS weiß vorgedämmt S6 WLS 035

## Uponor Uni Pipe PLUS weiß vorgedämmt S10 WLS 035

 <b>1062181</b>	16x2,0 blau	450	75	$\frac{m}{E1}$	<b>8,11</b>
<b>1062182</b>	20x2,25 blau	525	75	$\frac{m}{E1}$	<b>10,51</b>
<b>1062183</b>	25x2,5 blau	350	50	$\frac{m}{E1}$	<b>23,25</b>

## Uponor Uni Pipe PLUS weiß vorgedämmt DHS9

 <b>1063559</b>	16x2,0 blau	525	75	$\frac{m}{E1}$	<b>9,02</b>
<b>1063560</b>	20x2,25 blau	525	75	$\frac{m}{E1}$	<b>11,35</b>

## Uponor Uni Pipe PLUS weiß vorgedämmt DHS26

 <b>1063561</b>	16x2,0 blau	200	25	$\frac{m}{E1}$	<b>15,87</b>
<b>1063562</b>	20x2,25 blau	200	25	$\frac{m}{E1}$	<b>18,24</b>

## Uponor Uni Pipe PLUS weiß im Schutzrohr

 <b>1063061</b>	16x2,0 - 25/20 rot	1125	75	$\frac{m}{E1}$	<b>7,20</b>
<b>1063059</b>	16x2,0 - 25/20 blau	1125	75	$\frac{m}{E1}$	<b>7,20</b>
<b>1063062</b>	20x2,25 - 28/23 rot	900	75	$\frac{m}{E1}$	<b>11,12</b>
<b>1063060</b>	20x2,25 - 28/23 blau	900	75	$\frac{m}{E1}$	<b>11,12</b>

## Uponor Teck Schutzrohr schwarz

 <b>1012860</b>	25/20 50m	2500	50	$\frac{m}{EZ}$	<b>2,24</b>
<b>1012864</b>	28/23 50m	2000	50	$\frac{m}{EZ}$	<b>2,32</b>
<b>1012869</b>	35/29 50m	1400	50	$\frac{m}{EZ}$	<b>4,00</b>
<b>1012872</b>	43/36 25m	600	25	$\frac{m}{EZ}$	<b>5,88</b>

## Uponor Teck Schutzrohr blau

 <b>1012859</b>	25/20 50m	2500	50	$\frac{m}{EZ}$	<b>2,24</b>
<b>1012863</b>	28/23 50m	2000	50	$\frac{m}{EZ}$	<b>2,32</b>
<b>1012867</b>	35/29 50m	1400	50	$\frac{m}{EZ}$	<b>4,00</b>

## Uponor Teck Schutzrohr rot

 <b>1012858</b>	25/20 50m	2500	50	$\frac{m}{EZ}$	<b>2,24</b>
<b>1012862</b>	28/23 50m	2000	50	$\frac{m}{EZ}$	<b>2,32</b>
<b>1012866</b>	35/29 50m	1400	50	$\frac{m}{EZ}$	<b>4,00</b>

# Uponor S-Press PLUS PPSU

Art-Nr.	Dimension	LE	VE	ME RG	Preis/ME
<b>Uponor S-Press PLUS Winkel PPSU</b>					
 1039929	16-16	80	20	St. E1	9,16
1039930	20-20	80	10	St. E1	11,95
1039931	25-25	80	10	St. E1	21,58
1039932	32-32	20	5	St. E1	29,71

<b>Uponor S-Press Verbund Winkel PPSU</b>					
 1046386	40-40	960	5	St. E1	60,82
1046387	50-50	576	3	St. E1	78,35
1032877	63-63	210	1	St. E1	144,98
1032878	75-75	210	1	St. E1	222,70

<b>Uponor S-Press Verbund Winkel 45° PPSU</b>					
 1046388	40-40	960	5	St. E1	60,78
1046389	50-50	576	3	St. E1	83,38
1032879	63-63	192	1	St. E1	152,95
1032880	75-75	192	1	St. E1	208,07

<b>Uponor S-Press PLUS Kupplung PPSU</b>					
 1039933	16-16	80	20	St. E1	7,39
1039934	20-20	80	10	St. E1	10,11
1039935	25-25	80	10	St. E1	14,98
1039936	32-32	80	10	St. E1	22,01

<b>Uponor S-Press Verbund Kupplung PPSU</b>					
 1046401	40-40	960	5	St. E1	42,54
1046402	50-50	576	3	St. E1	56,36
1032881	63-63	384	1	St. E1	105,69
1032882	75-75	384	1	St. E1	170,99

<b>Uponor S-Press PLUS Kupplung reduziert PPSU</b>					
 1039937	20-16	80	20	St. E1	10,30
1039938	25-16	80	10	St. E1	13,98
1039939	25-20	80	10	St. E1	13,98
1039940	32-25	80	10	St. E1	22,52

<b>Uponor S-Press Kupplung reduziert PPSU</b>					
 1039941	40-25	960	5	St. E1	39,73
1039942	40-32	960	5	St. E1	39,73
1039943	50-32	1152	3	St. E1	51,77
1046406	50-40	576	3	St. E1	56,91
1032883	63-40	384	1	St. E1	98,14
1032884	63-50	384	1	St. E1	100,23
1032885	75-50	384	1	St. E1	144,22
1032886	75-63	384	1	St. E1	159,49

Art-Nr.	Dimension	LE	VE	ME RG	Preis/ME
<b>Uponor S-Press PLUS T-Stück PPSU</b>					
 1039944	16-16-16	80	10	St. E1	14,32
1039945	20-20-20	80	10	St. E1	20,44
1039946	25-25-25	20	5	St. E1	24,53
1039947	32-32-32	20	5	St. E1	40,27

<b>Uponor S-Press Verbund T-Stück PPSU</b>					
 1046390	40-40-40	720	5	St. E1	87,65
1046391	50-50-50	288	3	St. E1	103,67
1032887	63-63-63	150	1	St. E1	184,41
1032888	75-75-75	150	1	St. E1	290,64

<b>Uponor S-Press PLUS T-Stück reduziert PPSU</b>					
 1039948	16-20-16	80	10	St. E1	20,44
1039949	20-16-16	80	10	St. E1	20,44
1039950	20-16-20	80	10	St. E1	20,44
1039951	20-20-16	80	10	St. E1	20,44
1039952	20-25-20	80	10	St. E1	26,74
1039953	25-16-16	80	10	St. E1	26,74
1039954	25-16-20	80	10	St. E1	26,74
1039955	25-16-25	80	10	St. E1	26,74
1039956	25-20-20	80	10	St. E1	26,74
1039957	25-20-25	80	10	St. E1	26,74
1039958	32-16-32	20	5	St. E1	43,25
1039959	32-20-32	20	5	St. E1	43,25
1039960	32-25-25	20	5	St. E1	43,25
1039961	32-25-32	20	5	St. E1	43,25

<b>Uponor S-Press T-Stück reduziert PPSU</b>					
 1039962	40-20-40	960	5	St. E1	78,23
1039963	40-25-32	960	5	St. E1	78,23
1039964	40-25-40	720	5	St. E1	78,23
1039965	40-32-32	960	5	St. E1	78,23
1039966	40-32-40	720	5	St. E1	78,23
1039967	50-25-40	432	3	St. E1	90,87
1039968	50-25-50	432	3	St. E1	90,87
1039969	50-32-50	432	3	St. E1	90,87

<b>Uponor S-Press Verbund T-Stück reduziert PPSU</b>					
 1046400	50-40-50	288	3	St. E1	100,06
1032889	63-25-63	150	1	St. E1	167,60
1032890	63-32-63	150	1	St. E1	173,07
1032891	63-40-63	150	1	St. E1	173,07
1032892	75-32-75	150	1	St. E1	218,90
1032893	75-40-75	150	1	St. E1	252,93
1032894	75-50-75	150	1	St. E1	252,93

Installation

Flächenheizung  
und -kühlung

Nahwärme-  
versorgung

Werkzeuge

Anhang

# Uponor S-Press PLUS 14 mm

Art-Nr.	Dimension	LE	VE	ME RG	Preis/ME
 <b>1014513</b>	14-R $\frac{1}{2}$ "MT	80	20	St. E1	<b>13,33</b>

## Uponor S-Press Übergangsmuffe

 <b>1014515</b>	14-Rp $\frac{1}{2}$ "FT	80	20	St. E1	<b>17,70</b>
--	-------------------------	----	----	-----------	--------------

## Uponor S-Press Winkel

 <b>NEU</b> <b>1133445</b>	14-14	80	20	St. E1	<b>16,93</b>
---	-------	----	----	-----------	--------------

## Uponor S-Press Kupplung

 <b>1015154</b>	14-14	80	10	St. D1	<b>14,66</b>
--	-------	----	----	-----------	--------------

## Uponor S-Press Kupplung reduziert

 <b>1015162</b>	16-14	80	20	St. E1	<b>14,14</b>
--	-------	----	----	-----------	--------------

## Uponor S-Press T-Stück

 <b>1014886</b>	14-14-14	80	10	St. E1	<b>23,33</b>
--	----------	----	----	-----------	--------------

## Uponor S-Press T-Stück reduziert

 <b>1014888</b>	14-16-14	80	10	St. E1	<b>31,09</b>
<b>1014912</b>	16-14-14	80	10	St. E1	<b>31,09</b>
<b>1014915</b>	16-14-16	80	10	St. E1	<b>31,09</b>

Art-Nr.	Dimension	LE	VE	ME RG	Preis/ME
 <b>1014511</b>	14-15CU	80	10	St. E1	<b>34,55</b>

## Uponor Smart Aqua Wandscheibe S-Press

 <b>1015437</b>	14-Rp $\frac{1}{2}$ "FT	40	10	St. E1	<b>28,18</b>
--	-------------------------	----	----	-----------	--------------

## Uponor S-Press Doppel-Wands. 90° long

 <b>NEU</b> <b>1133446</b>	14-Rp $\frac{1}{2}$ "FT-14	40	10	St. E1	<b>51,33</b>
---	----------------------------	----	----	-----------	--------------

## Uponor Smart Radi Anschlusswinkel S-Press

 <b>1015615</b>	14-15CU l=350mm	640	20	St. E2	<b>29,77</b>
--	-----------------	-----	----	-----------	--------------



# Uponor S-Press PLUS

Art-Nr.	Dimension	LE	VE	ME RG	Preis/ME
---------	-----------	----	----	----------	----------

## Uponor S-Press PLUS Übergangsnippel

 <b>1070502</b>	16-R½"MT	80	20	St. E1	<b>11,58</b>
<b>1070503</b>	16-R¾"MT	120	15	St. E1	<b>15,37</b>
<b>1070504</b>	20-R½"MT	80	20	St. E1	<b>17,51</b>
<b>1070505</b>	20-R¾"MT	80	10	St. E1	<b>17,51</b>
<b>1070506</b>	20-R1"MT	80	10	St. E1	<b>24,65</b>
<b>1070507</b>	25-R¾"MT	80	10	St. E1	<b>23,80</b>
<b>1070508</b>	25-R1"MT	40	5	St. E1	<b>28,12</b>
<b>1070509</b>	32-R1"MT	40	5	St. E1	<b>30,96</b>
<b>1070510</b>	32-R1 ¼"MT	20	5	St. E1	<b>40,12</b>

## Uponor S-Press Übergangsnippel

 <b>1046901</b>	40-R1 ¼"MT	960	5	St. E1	<b>50,14</b>
<b>1046902</b>	40-R1 ½"MT	960	5	St. E1	<b>55,43</b>
<b>1046905</b>	50-R1 ½"MT	1152	3	St. E1	<b>83,17</b>
<b>1046906</b>	50-R2"MT	576	3	St. E1	<b>106,88</b>
<b>1032895</b>	63-R2"MT	336	1	St. E1	<b>151,75</b>
<b>1032896</b>	75-R2 ½"MT	336	1	St. E1	<b>200,05</b>

## Uponor S-Press PLUS Übergangsmuffe

 <b>1070515</b>	16-Rp½"FT	80	20	St. E1	<b>13,72</b>
<b>1070516</b>	20-Rp½"FT	120	15	St. E1	<b>20,56</b>
<b>1070517</b>	20-Rp¾"FT	80	10	St. E1	<b>20,56</b>
<b>1070518</b>	20-Rp1"FT	80	20	St. E1	<b>28,53</b>
<b>1070519</b>	25-Rp¾"FT	40	5	St. E1	<b>27,68</b>
<b>1070520</b>	25-Rp1"FT	40	5	St. E1	<b>29,14</b>
<b>1070521</b>	32-Rp1"FT	40	5	St. E1	<b>33,88</b>
<b>1070522</b>	32-Rp1 ¼"FT	20	5	St. E1	<b>41,80</b>

## Uponor S-Press Übergangsmuffe

 <b>1046903</b>	40-Rp1 ¼"FT	960	5	St. E1	<b>52,16</b>
<b>1046904</b>	40-Rp1 ½"FT	960	5	St. E1	<b>52,71</b>
<b>1046907</b>	50-Rp1 ½"FT	1152	3	St. E1	<b>127,09</b>

## Uponor S-Press PLUS Winkel

 <b>1070523</b>	16-16	80	20	St. E1	<b>13,76</b>
<b>1070524</b>	20-20	80	10	St. E1	<b>18,52</b>
<b>1070525</b>	25-25	40	5	St. E1	<b>26,99</b>
<b>1070526</b>	32-32	20	5	St. E1	<b>40,92</b>

## Uponor S-Press Winkel

 <b>1046908</b>	40-40	600	5	St. E1	<b>61,53</b>
<b>1046911</b>	50-50	240	3	St. E1	<b>81,64</b>

Art-Nr.	Dimension	LE	VE	ME RG	Preis/ME
---------	-----------	----	----	----------	----------

## Uponor S-Press PLUS Bogen

 <b>1070527</b>	16-16	80	10	St. E1	<b>19,70</b>
<b>1070528</b>	20-20	80	10	St. E1	<b>23,26</b>
<b>1070529</b>	25-25	40	5	St. E1	<b>33,93</b>
<b>1070530</b>	32-32	20	5	St. E1	<b>42,95</b>

## Uponor S-Press PLUS Winkelnippel

 <b>1070532</b>	16-R½"MT	80	20	St. E1	<b>16,55</b>
<b>1070533</b>	20-R½"MT	80	10	St. E1	<b>28,71</b>
<b>1070534</b>	20-R¾"MT	80	10	St. E1	<b>37,07</b>
<b>1070535</b>	25-R¾"MT	40	5	St. E1	<b>35,92</b>
<b>1070536</b>	25-R1"MT	40	5	St. E1	<b>44,04</b>
<b>1070537</b>	32-R1"MT	20	5	St. E1	<b>54,26</b>

## Uponor S-Press Winkelnippel

 <b>1046909</b>	40-R1 ¼"MT	500	5	St. E1	<b>92,73</b>
--	------------	-----	---	-----------	--------------

## Uponor S-Press PLUS Winkelmuffe

 <b>1070539</b>	16-Rp½"FT	80	10	St. E1	<b>19,27</b>
<b>1070540</b>	20-Rp½"FT	80	10	St. E1	<b>32,60</b>
<b>1070541</b>	20-Rp¾"FT	40	10	St. E1	<b>34,07</b>
<b>1070542</b>	25-Rp¾"FT	20	5	St. E1	<b>42,12</b>
<b>1070543</b>	25-Rp1"FT	20	5	St. E1	<b>51,97</b>
<b>1070544</b>	32-Rp1"FT	20	5	St. E1	<b>66,35</b>

## Uponor S-Press Winkelmuffe

 <b>1046910</b>	40-Rp1 ½"FT	500	5	St. E1	<b>94,16</b>
<b>1046912</b>	50-Rp1 ½"FT	300	3	St. E1	<b>110,33</b>

## Uponor S-Press PLUS Winkel 45°

 <b>1070545</b>	25-25	20	5	St. E1	<b>40,92</b>
<b>1070546</b>	32-32	20	5	St. E1	<b>69,22</b>

## Uponor S-Press Winkel 45°

 <b>1046913</b>	40-40	500	5	St. E1	<b>71,35</b>
<b>1046914</b>	50-50	300	3	St. E1	<b>98,15</b>

## Uponor S-Press PLUS Kupplung

 <b>1070547</b>	16-16	80	20	St. D1	<b>11,76</b>
<b>1070548</b>	20-20	80	10	St. E1	<b>14,67</b>
<b>1070549</b>	25-25	80	10	St. E1	<b>22,43</b>
<b>1070550</b>	32-32	40	5	St. E1	<b>27,57</b>

Installation

Flächenheizung  
und -kühlung

Nahwärme-  
versorgung

Werkzeuge

Anhang

# Uponor S-Press PLUS

Art-Nr.	Dimension	LE	VE	ME RG	Preis/ME
<b>Uponor S-Press PLUS Schiebekupplung</b>					
 <b>1118706</b>	16-16	80	10	St. E1	<b>72,83</b>
<b>1118707</b>	20-20	80	10	St. E1	<b>85,00</b>
<b>1118708</b>	25-25	40	5	St. E1	<b>101,44</b>
<b>1118709</b>	32-32	20	5	St. E1	<b>110,10</b>
<b>1118710</b>	40-40	12	3	St. E1	<b>182,34</b>

## Uponor S-Press Kupplung

 <b>1046932</b>	40-40	960	5	St. E1	<b>48,08</b>
<b>1046935</b>	50-50	576	3	St. E1	<b>62,31</b>

## Uponor S-Press PLUS Kupplung reduziert

 <b>1070552</b>	20-16	80	20	St. E1	<b>14,43</b>
<b>1070553</b>	25-16	80	10	St. E1	<b>22,08</b>
<b>1070554</b>	25-20	80	10	St. E1	<b>22,37</b>
<b>1070555</b>	32-20	80	10	St. E1	<b>27,91</b>
<b>1070556</b>	32-25	80	10	St. E1	<b>29,44</b>

## Uponor S-Press Kupplung reduziert

 <b>1046930</b>	40-25	960	5	St. E1	<b>45,80</b>
<b>1046931</b>	40-32	960	5	St. E1	<b>46,35</b>
<b>1046933</b>	50-32	1152	3	St. E1	<b>54,31</b>
<b>1046934</b>	50-40	576	3	St. E1	<b>55,31</b>

## Uponor S-Press PLUS T-Stück

 <b>1070560</b>	16-16-16	80	10	St. E1	<b>18,33</b>
<b>1070561</b>	20-20-20	80	10	St. E1	<b>24,69</b>
<b>1070562</b>	25-25-25	20	5	St. E1	<b>35,92</b>
<b>1070563</b>	32-32-32	20	5	St. E1	<b>60,06</b>

## Uponor S-Press T-Stück

 <b>1046921</b>	40-40-40	400	5	St. E1	<b>84,06</b>
<b>1046928</b>	50-50-50	300	3	St. E1	<b>110,48</b>

Art-Nr.	Dimension	LE	VE	ME RG	Preis/ME
<b>Uponor S-Press PLUS T-Stück reduziert</b>					
 <b>1070566</b>	16-20-16	80	10	St. E1	<b>26,06</b>
<b>1070567</b>	20-16-16	40	10	St. E1	<b>26,06</b>
<b>1070568</b>	20-16-20	80	20	St. E1	<b>25,21</b>
<b>1070569</b>	20-20-16	80	20	St. E1	<b>25,21</b>
<b>1070570</b>	20-25-16	40	10	St. E1	<b>35,28</b>
<b>1070571</b>	20-25-20	40	10	St. E1	<b>35,28</b>
<b>1070572</b>	25-16-16	40	5	St. E1	<b>35,28</b>
<b>1070573</b>	25-16-20	40	5	St. E1	<b>35,28</b>
<b>1070574</b>	25-16-25	20	5	St. E1	<b>35,28</b>
<b>1070575</b>	25-20-16	40	5	St. E1	<b>35,28</b>
<b>1070576</b>	25-20-20	40	5	St. E1	<b>35,28</b>
<b>1070577</b>	25-20-25	20	5	St. E1	<b>35,28</b>
<b>1070578</b>	25-25-16	20	5	St. E1	<b>35,28</b>
<b>1070579</b>	25-32-25	20	5	St. E1	<b>67,16</b>
<b>1070580</b>	32-16-32	20	5	St. E1	<b>67,16</b>
<b>1070581</b>	32-20-32	20	5	St. E1	<b>67,16</b>
<b>1070582</b>	32-25-25	20	5	St. E1	<b>67,16</b>
<b>1070583</b>	32-25-32	20	5	St. E1	<b>67,16</b>

## Uponor S-Press T-Stück reduziert

 <b>1046916</b>	40-20-40	400	5	St. E1	<b>81,97</b>
<b>1046917</b>	40-25-32	500	5	St. E1	<b>73,06</b>
<b>1046918</b>	40-25-40	400	5	St. E1	<b>81,97</b>
<b>1046919</b>	40-32-32	400	5	St. E1	<b>75,18</b>
<b>1046920</b>	40-32-40	400	5	St. E1	<b>81,97</b>
<b>1046924</b>	50-25-40	300	3	St. E1	<b>109,72</b>
<b>1046925</b>	50-25-50	240	3	St. E1	<b>116,02</b>
<b>1046926</b>	50-32-50	300	3	St. E1	<b>116,03</b>
<b>1046927</b>	50-40-50	300	3	St. E1	<b>117,67</b>

## Uponor S-Press PLUS T-Stück m. Aussengewinde

 <b>1070592</b>	16-R $\frac{1}{2}$ "MT-16	40	10	St. E1	<b>41,54</b>
<b>1070593</b>	25-R $\frac{3}{4}$ "MT-25	20	5	St. E1	<b>53,42</b>
<b>1070594</b>	32-R $\frac{3}{4}$ "MT-32	20	5	St. E1	<b>65,97</b>

## Uponor S-Press PLUS T-Stück m. Innengewinde

 <b>1070595</b>	16-Rp $\frac{1}{2}$ "FT-16	40	10	St. E1	<b>36,08</b>
<b>1070596</b>	20-Rp $\frac{1}{2}$ "FT-20	60	15	St. E1	<b>40,79</b>
<b>1070597</b>	20-Rp $\frac{3}{4}$ "FT-20	40	10	St. E1	<b>43,41</b>
<b>1070598</b>	25-Rp $\frac{1}{2}$ "FT-25	20	5	St. E1	<b>46,12</b>
<b>1070599</b>	25-Rp $\frac{3}{4}$ "FT-25	20	5	St. E1	<b>50,15</b>
<b>1070600</b>	32-Rp $\frac{1}{2}$ "FT-32	20	5	St. E1	<b>66,08</b>
<b>1070601</b>	32-Rp $\frac{3}{4}$ "FT-32	20	5	St. E1	<b>66,08</b>

# Uponor S-Press PLUS

Art-Nr.	Dimension	LE	VE	ME RG	Preis/ME
 <b>1046922</b>	40-Rp½"FT-40	500	5	St. E1	<b>76,88</b>
<b>1046923</b>	40-Rp¾"FT-40	400	5	St. E1	<b>76,88</b>
<b>1046929</b>	50-Rp1"FT-50	240	3	St. E1	<b>127,87</b>

## Uponor S-Press PLUS Verschraubung IG

 <b>1070602</b>	16-G½"SN	30	1	St. E1	<b>26,42</b>
<b>1070603</b>	16-G¾"SN	20	1	St. E1	<b>31,80</b>
<b>1070604</b>	20-G½"SN	20	1	St. E1	<b>29,00</b>
<b>1070605</b>	20-G¾"SN	20	1	St. E1	<b>35,63</b>
<b>1070606</b>	25-G¾"SN	15	1	St. E1	<b>40,42</b>
<b>1070607</b>	25-G1"SN	15	1	St. E1	<b>40,42</b>
<b>1070608</b>	25-G1 ¼"SN	10	1	St. E1	<b>46,42</b>
<b>1070609</b>	32-G1"SN	10	1	St. E1	<b>54,19</b>
<b>1070610</b>	32-G1 ¼"SN	10	1	St. E1	<b>47,40</b>

## Uponor S-Press Verschraubung IG

 <b>1060094</b>	40-G1 ¼"SN	960	5	St. E1	<b>101,25</b>
<b>1046937</b>	40-G1 ½"SN	960	5	St. E1	<b>78,64</b>
<b>1060095</b>	50-G1 ½"SN	1152	3	St. E1	<b>106,88</b>
<b>1046938</b>	50-G1 ¾"SN	1152	3	St. E1	<b>82,74</b>
<b>1046939</b>	50-G2"SN	576	3	St. E1	<b>90,12</b>

## Uponor S-Press PLUS Winkelverschraubung IG

 <b>1070611</b>	16-G¾"SN	20	1	St. E1	<b>28,96</b>
<b>1070612</b>	16-G½"SN	20	1	St. E1	<b>29,08</b>
<b>1105818</b>	16-G¾"SN	10	1	St. E1	<b>31,32</b>
<b>1070613</b>	20-G½"SN	20	1	St. E1	<b>34,86</b>
<b>1105819</b>	20-G¾"SN	10	1	St. E1	<b>32,73</b>
<b>1070614</b>	25-G¾"SN	10	1	St. E1	<b>37,66</b>

## Uponor S-Press PLUS Wandscheibe M

 <b>1070638</b>	16-Rp¾"FT	40	10	St. E1	<b>27,60</b>
<b>1070639</b>	16-Rp½"FT	40	10	St. E1	<b>22,65</b>
<b>1070640</b>	20-Rp½"FT	40	10	St. E1	<b>27,60</b>
<b>1070641</b>	20-Rp¾"FT	20	5	St. E1	<b>30,03</b>
<b>1070642</b>	25-Rp¾"FT	20	5	St. E1	<b>37,47</b>

## Uponor S-Press PLUS Wandscheibe L

 <b>1070644</b>	16-Rp½"FT	40	10	St. E1	<b>30,99</b>
<b>1070645</b>	20-Rp½"FT	40	10	St. E1	<b>35,73</b>

Art-Nr.	Dimension	LE	VE	ME RG	Preis/ME
 <b>1070646</b>	16-Rp½"FT	40	10	St. E1	<b>37,84</b>
<b>1070647</b>	20-Rp½"FT	40	10	St. E1	<b>39,82</b>

## Uponor S-Press PLUS Schallset 2 Wandscheiben

 <b>1121193</b>	16-20	192	1	Set E1	<b>42,73</b>
--	-------	-----	---	-----------	--------------

## Uponor S-Press PLUS U-Wandscheibe

 <b>1070629</b>	16-Rp½"FT-16	20	5	St. E1	<b>56,33</b>
<b>1070630</b>	20-Rp½"FT-20	960	5	St. E1	<b>70,08</b>
<b>1070631</b>	20-Rp½"FT-16	960	5	St. E1	<b>78,72</b>
<b>1070632</b>	16-Rp½"FT-20	960	5	St. E1	<b>78,72</b>
<b>1070633</b>	25-Rp½"FT-25	576	3	St. E1	<b>116,24</b>
<b>1070634</b>	25-Rp½"FT-20	576	3	St. E1	<b>123,40</b>
<b>1070635</b>	20-Rp½"FT-25	576	3	St. E1	<b>133,77</b>

## Uponor S-Press PLUS Schallset U-Wandscheibe

 <b>1121194</b>	16-20	384	1	St. E1	<b>25,33</b>
--	-------	-----	---	-----------	--------------

## Uponor S-Press PLUS U-Armaturenanschluss

 <b>1070636</b>	16-16-R½"MT	960	5	St. E1	<b>102,88</b>
<b>1070637</b>	20-20-R¾"MT	960	5	St. E1	<b>102,88</b>

## Uponor S-Press PLUS Doppel-Wands. 90° L long

 <b>1070648</b>	16-Rp½"FT-16	40	10	St. E1	<b>51,48</b>
<b>1070649</b>	20-Rp½"FT-20	40	10	St. E1	<b>60,20</b>

## Uponor S-Press PLUS Anschlusswink. flach

 <b>1070657</b>	16-Rp½"FT	10	1	St. E1	<b>37,36</b>
--	-----------	----	---	-----------	--------------

## Uponor S-Press PLUS SK-T-Stück Geberit

 <b>1070659</b>	16-G½"FT-16	10	1	St. E1	<b>44,47</b>
--	-------------	----	---	-----------	--------------

## Uponor S-Press PLUS SK-Winkelverschraub. Geberit

 <b>1070658</b>	16-½"FT	80	20	St. E1	<b>23,70</b>
--	---------	----	----	-----------	--------------

Installation

 Flächenheizung  
und -kühlung

 Nahwärme-  
versorgung

Werkzeuge

Anhang

# Uponor S-Press PLUS

Art-Nr.	Dimension	LE	VE	ME RG	Preis/ME
---------	-----------	----	----	----------	----------

## Uponor Smart Aqua SK-Verschraubung Geberit

 <b>1058097</b>	16-½"FT	25	1	St. E1	<b>14,26</b>
--	---------	----	---	-----------	--------------

## Uponor S-Press PLUS Endstück

 <b>1070621</b>	16	160	40	St. E1	<b>11,65</b>
<b>1070622</b>	20	7680	20	St. E1	<b>19,75</b>
<b>1070623</b>	25	3840	10	St. E1	<b>22,73</b>
<b>1070624</b>	32	1920	5	St. E1	<b>28,84</b>

## Uponor S-Press PLUS Abdrückstopfen

 <b>1013754</b>	14	7680	20	St. E1	<b>26,55</b>
<b>1013756</b>	16	7680	20	St. E1	<b>26,55</b>
<b>1013760</b>	20	3840	20	St. E1	<b>28,61</b>
<b>1013762</b>	25	3840	10	St. E1	<b>31,33</b>
<b>1013764</b>	32	3840	10	St. E1	<b>48,08</b>
<b>1013765</b>	40	960	5	St. E1	<b>61,53</b>

## Uponor S-Press PLUS O-Ring für Abdrückstopfen

 <b>1013798</b>	14	10000	10	St. E1	<b>0,65</b>
<b>1013799</b>	16	1000	10	St. E1	<b>0,83</b>
<b>1013801</b>	20	1000	10	St. E1	<b>1,17</b>
<b>1013802</b>	25	500	10	St. E1	<b>1,31</b>
<b>1013803</b>	32	500	10	St. E1	<b>1,31</b>
<b>1013804</b>	40	10000	10	St. E1	<b>1,78</b>

## Uponor S-Press PLUS Montageeinheit mit Schallset

 <b>1070666</b>	16-Rp½"FT c/c150mm	150	5	St. E1	<b>86,35</b>
--	--------------------	-----	---	-----------	--------------

## Uponor S-Press PLUS Montageeinheit

 <b>1070661</b>	16-Rp½"FT c/c80mm	5	1	St. E1	<b>65,34</b>
<b>1070662</b>	16-Rp½"FT c/c150mm	380	5	St. E1	<b>65,34</b>

## Uponor S-Press PLUS Montageeinheit Gemini

 <b>1070663</b>	16-Rp½"FT c/c120mm	720	5	St. E1	<b>65,75</b>
<b>1070664</b>	16-Rp½"FT c/c150mm	720	5	St. E1	<b>65,75</b>

Art-Nr.	Dimension	LE	VE	ME RG	Preis/ME
---------	-----------	----	----	----------	----------

## Uponor S-Press PLUS Mauerdurchführung

 <b>1070652</b>	16-G½"FT	5	1	St. E1	<b>40,93</b>
--	----------	---	---	-----------	--------------

## Uponor S-Press PLUS Wanddurchführung Eck LWC

 <b>1070653</b>	16-Rp½"FT l=25	5	1	St. E1	<b>72,46</b>
<b>1070654</b>	16-Rp½"FT l=35	5	1	St. E1	<b>73,99</b>

## Uponor S-Press PLUS U-Wanddurchführ. Eck LWC

 <b>1070655</b>	16-Rp½"FT-16 l=25	5	1	St. E1	<b>123,81</b>
<b>1070656</b>	16-Rp½"FT-16 l=35	5	1	St. E1	<b>126,67</b>

## Uponor S-Press PLUS Montageplatte

 <b>1121197</b>	80/150mm	5	1	St. E1	<b>13,30</b>
--	----------	---	---	-----------	--------------

## Uponor S-Press PLUS Montagewinkel

 <b>1121196</b>	100mm	5	1	St. E1	<b>15,05</b>
<b>1121195</b>	80/150mm	5	1	St. E1	<b>16,63</b>

## Uponor Smart Aqua Montagewinkel Gemini

 <b>1059824</b>	120mm	5	1	St. E1	<b>9,33</b>
<b>1059825</b>	150mm	5	1	St. E1	<b>9,88</b>

## Uponor Smart Aqua Einzelmontagewinkel

 <b>1057843</b>		5	1	St. E1	<b>10,54</b>
--	--	---	---	-----------	--------------

## Uponor Smart Aqua Montageschiene

 <b>1057844</b>	2m	10	1	St. E1	<b>52,96</b>
--	----	----	---	-----------	--------------

## Uponor Smart Aqua Biegezange f. Schiene

 <b>1015424</b>	2m	100	1	St. NET	<b>169,65</b>
--	----	-----	---	------------	---------------

## Uponor Smart Aqua 10 Bolzen+20 Schrauben

 <b>1057847</b>		-	1	Set E1	<b>17,71</b>
--	--	---	---	-----------	--------------

# Uponor S-Press PLUS Systemübergänge

Art-Nr.	Dimension	LE	VE	ME RG	Preis/ME
 <b>1015168</b>	16-16	80	20	St. U2	<b>22,47</b>
<b>1015192</b>	20-20	3840	10	St. U2	<b>23,51</b>
<b>1015210</b>	25-26	1920	5	St. U2	<b>40,49</b>
<b>1015224</b>	32-32	1920	5	St. U2	<b>40,91</b>

## Uponor S-Press Übergangskupplung auf Rapex

 <b>1015167</b>	16-16	80	20	St. U2	<b>22,47</b>
<b>1015190</b>	20-20	3840	10	St. U2	<b>23,51</b>
<b>1015208</b>	25-26	1920	5	St. U2	<b>33,01</b>
<b>1015222</b>	32-32	1920	5	St. U2	<b>38,32</b>

## Uponor S-Press Kupplung auf Edelstahl/CU V

 <b>1090678</b>	16-15CU-SST	10	1	St. E1	<b>28,34</b>
<b>1090679</b>	20-22CU-SST	5	1	St. E1	<b>41,25</b>
<b>1090680</b>	25-22CU-SST	5	1	St. E1	<b>43,95</b>
<b>1090681</b>	32-28CU-SST	5	1	St. E1	<b>62,28</b>

## Uponor S-Press Kupplung auf Edelstahl/CU M

 <b>1090682</b>	16-15CU-SST	10	1	St. E1	<b>28,34</b>
<b>1090683</b>	20-22CU-SST	5	1	St. E1	<b>41,25</b>
<b>1090684</b>	25-22CU-SST	5	1	St. E1	<b>43,95</b>
<b>1090685</b>	32-28CU-SST	5	1	St. E1	<b>62,28</b>

Art-Nr.	Dimension	LE	VE	ME RG	Preis/ME
 <b>1070705</b>	16-10CU	80	20	St. E1	<b>18,73</b>
<b>1070706</b>	16-12CU	80	20	St. E1	<b>18,81</b>
<b>1070615</b>	16-15CU	160	20	St. E1	<b>18,98</b>
<b>1070616</b>	20-18CU	40	10	St. E1	<b>25,01</b>
<b>1070617</b>	20-22CU	60	15	St. E1	<b>25,70</b>
<b>1070618</b>	25-22CU	20	5	St. E1	<b>30,96</b>
<b>1070620</b>	32-28CU	20	5	St. E1	<b>46,87</b>

## Uponor S-Press Kupplung reduziert

 <b>1015172</b>	18-16	80	20	St. E1	<b>23,52</b>
<b>1015185</b>	20-18	80	10	St. E1	<b>23,85</b>

## Uponor S-Press Übergang auf Edelstahl SST

 <b>1089056</b>	16-15SST	10	1	St. E1	<b>24,53</b>
<b>1089057</b>	20-22SST	10	1	St. E1	<b>34,71</b>
<b>1089058</b>	25-22SST	5	1	St. E1	<b>35,56</b>
<b>1089059</b>	32-28SST	5	1	St. E1	<b>53,46</b>

Lieferung solange Vorrat reicht. Artikel läuft im Laufe des Jahres aus.

Installation

 Flächenheizung  
und -kühlung

 Nahwärme-  
versorgung

Werkzeuge

Anhang

# S-Press PLUS Ventile

Art-Nr.	Dimension	LE	VE	ME RG	Preis/ME
---------	-----------	----	----	----------	----------

## Uponor S-Press PLUS Schrägsitzventil

 <b>1119311</b>	20	5	1	St. E1	<b>118,55</b>
<b>1119312</b>	25	5	1	St. E1	<b>177,89</b>
<b>1119313</b>	32	5	1	St. E1	<b>266,77</b>
<b>1119314</b>	40	5	1	St. E1	<b>311,28</b>

## Uponor S-Press PLUS Schrägsitzventil RV

 <b>1119315</b>	20	5	1	St. E1	<b>148,22</b>
<b>1119316</b>	25	5	1	St. E1	<b>186,79</b>
<b>1119317</b>	32	5	1	St. E1	<b>287,54</b>
<b>1119318</b>	40	5	1	St. E1	<b>361,59</b>

## Uponor S-Press PLUS Dämmschale

 <b>NEU</b> <b>1137490</b>	DN 20	10	1	St. E1	<b>21,89</b>
<b>NEU</b> <b>1137491</b>	DN 25	10	1	St. E1	<b>23,81</b>
<b>NEU</b> <b>1137492</b>	DN 32/40	5	1	St. E1	<b>31,30</b>

Art-Nr.	Dimension	LE	VE	ME RG	Preis/ME
---------	-----------	----	----	----------	----------

## Uponor S-Press PLUS Unterputzventil

 <b>1119321</b>	16	5	1	St. E1	<b>100,75</b>
<b>1119322</b>	20	5	1	St. E1	<b>149,64</b>
<b>1119323</b>	25	5	1	St. E1	<b>160,09</b>

## Uponor S-Press PLUS Zirkulationsventil

 <b>1119319</b>	16mm	-	1	St. E1	<b>462,47</b>
<b>1119320</b>	20mm	-	1	St. E1	<b>466,85</b>





## Uponor S-Press PLUS Probenahmeventil

 <b>NEU</b> <b>1119848</b>	DN 8	10	1	St. E1	<b>130,82</b>
---	------	----	---	-----------	---------------



## Uponor S-Press PLUS Wasserzählerbox

 <b>NEU</b> <b>1119324</b>	G2" Coax DN 3/4"	60	1	St. E1	<b>477,37</b>
--	------------------	----	---	-----------	---------------



# Uponor S-Press PLUS Heizung

Art-Nr.	Dimension	LE	VE	ME RG	Preis/ME
 <b>1070689</b>	16-16-16	192	1	St. E2	<b>94,37</b>
 <b>1070690</b>	20-16-16	192	1	St. E2	<b>100,77</b>
 <b>1070691</b>	20-16-20	192	1	St. E2	<b>100,77</b>
 <b>1070692</b>	20-20-20	192	1	St. E2	<b>97,68</b>



## Uponor Smart Radi Anschlussblock

 <b>1013134</b>	16 h=215mm	240	10	St. E2	<b>52,87</b>
 <b>1007077</b>	16 h=240mm	240	10	St. E2	<b>66,18</b>







## Uponor S-Press PLUS HK-Anschlusswinkel

 <b>1070678</b>	16-15CU l=350mm	1680	20	St. E2	<b>26,83</b>
 <b>1070679</b>	16-15CU l=1000mm	400	20	St. E2	<b>49,10</b>

## Uponor S-Press PLUS HK-Anschl. T-Stück

 <b>1070681</b>	16-15CU-16 l=350mm	600	20	St. E2	<b>46,59</b>
 <b>1070682</b>	20-15CU-20 l=350mm	600	20	St. E2	<b>60,14</b>



## Uponor S-Press PLUS SL-Anschlussgarnitur

 <b>1070693</b>	16-G½"MT-16	192	1	St. E2	<b>114,34</b>
 <b>1070694</b>	16-G½"MT-20	192	1	St. E2	<b>114,34</b>
 <b>1070695</b>	16-G½"MT-0	192	1	St. E2	<b>114,34</b>
 <b>1070696</b>	20-G½"MT-16	192	1	St. E2	<b>114,34</b>
 <b>1094219</b>	0-G½"MT-16	192	1	St. E2	<b>114,34</b>
 <b>1070697</b>	20-G½"MT-20	192	1	St. E2	<b>114,34</b>

## Uponor Smart Base SL-Winkel SL

 <b>1014060</b>	15x1	25	1	Set E2	<b>72,55</b>
--	------	----	---	-----------	--------------

## Uponor S-Press PLUS HK-Montageplatte Radi

 <b>1070683</b>	16-Rp½"FT c/c35mm	720	5	St. E2	<b>65,26</b>
 <b>1070684</b>	16-Rp½"FT c/c50mm	960	5	St. E2	<b>65,26</b>

## Uponor Smart Radi Anschlussrohr

 <b>1015425</b>	G½"MT-15CU l=350mm	640	20	St. E2	<b>36,53</b>
--	--------------------	-----	----	-----------	--------------

Art-Nr.	Dimension	LE	VE	ME RG	Preis/ME
 <b>1013830</b>	15CU-¾" Euro	80	10	St. D1	<b>9,06</b>

## Uponor Smart Radi Klemmverschraubung Cu

## Uponor Smart Radi Anschlussnippel

 <b>1013906</b>	G¾"MT-G½"MT	80	10	St. D1	<b>8,25</b>
--	-------------	----	----	-----------	-------------

## Uponor Smart Radi Anschlussgarnitur Danfoss

 <b>1013970</b>	16-G½"MT	20	1	St. E2	<b>10,44</b>
--	----------	----	---	-----------	--------------

## Uponor Smart Radi Anschlussgarnitur Heimeier

 <b>1013978</b>	16-G½"MT	20	1	St. E2	<b>9,85</b>
--	----------	----	---	-----------	-------------

## Uponor Smart Radi Anschlussgarnitur Oventrop

 <b>1014016</b>	16-G½"MT	20	1	St. E2	<b>13,78</b>
--	----------	----	---	-----------	--------------

## Uponor Smart Radi Anschlusset

 <b>1011364</b>		100	10	St. E2	<b>17,88</b>
--	--	-----	----	-----------	--------------

## Uponor Smart Radi Rosette weiß

 <b>1011370</b>	16 white	1350	50	St. E2	<b>0,99</b>
--	----------	------	----	-----------	-------------

## Uponor Smart Radi Stufen-Doppelrosette

 <b>1011373</b>	14-20 white double	500	50	St. D1	<b>3,57</b>
--	--------------------	-----	----	-----------	-------------

## Uponor S-Press Thermostatventil Aquastrom T plus

 <b>1013243</b>	G¾"MT	300	1	St. E1	<b>612,25</b>
--	-------	-----	---	-----------	---------------

Installation

Flächenheizung  
und -kühlung

Nahwärme-  
versorgung

Werkzeuge

Anhang



# Uponor RS

## Verteil- und Steigleitungen 63-110 mm



RS 2 Adapter	RS 2 Grundkörper	RS 3 Grundkörper	RS 3 Adapter
<ul style="list-style-type: none"> <li>40, 50, 63, 75</li> <li>1½", 2", 2½"</li> <li>¾", 1", 2", 2½"</li> <li>16, 20, 25, 32</li> <li>DN 65 (PN 6/PN 16)</li> <li>130 mm</li> <li>5 mm</li> </ul>	<ul style="list-style-type: none"> <li>RS 2 / RS 3</li> </ul>	<ul style="list-style-type: none"> <li>90, 110</li> <li>3"</li> <li>1½", 3"</li> <li>DN 80 (PN 6/PN 16)</li> <li>DN 100 (PN 6/PN 16)</li> <li>210 mm</li> <li>5 mm</li> </ul>	



# Uponor RS

Art-Nr.	Dimension	LE	VE	ME RG	Preis/ME
---------	-----------	----	----	----------	----------

## Uponor RS Kupplung

 <b>1029144</b>	RS2-RS2	480	1	St. E1	<b>48,01</b>
<b>1029145</b>	RS3-RS3	480	1	St. E1	<b>103,96</b>

## Uponor RS Winkel

 <b>1029138</b>	RS2-RS2	336	1	St. E1	<b>65,61</b>
<b>1029139</b>	RS3-RS3	240	1	St. E1	<b>168,84</b>

## Uponor RS Winkel 45°

 <b>1029140</b>	RS2-RS2	336	1	St. E1	<b>78,29</b>
<b>1029141</b>	RS3-RS3	175	1	St. E1	<b>205,28</b>

## Uponor RS T-Stück

 <b>1029142</b>	RS2-RS2-RS2	336	1	St. E1	<b>81,15</b>
<b>1029143</b>	RS3-RS3-RS3	175	1	St. E1	<b>220,15</b>

## Uponor RS Kupplung reduziert

 <b>1029146</b>	RS3-RS2	480	1	St. E1	<b>97,25</b>
--	---------	-----	---	-----------	--------------

## Uponor RS Distanzadapter

 <b>1046750</b>	RS2-RS2 l=5mm	480	1	St. E1	<b>74,26</b>
<b>1046751</b>	RS3-RS3 l=5mm	240	1	St. E1	<b>90,80</b>

## Uponor RS Distanzadapter

 <b>1046477</b>	RS2-RS2 l=130mm	240	1	St. E1	<b>130,95</b>
<b>1046478</b>	RS3-RS3 l=210mm	96	1	St. E1	<b>248,40</b>

Art-Nr.	Dimension	LE	VE	ME RG	Preis/ME
---------	-----------	----	----	----------	----------

## Uponor RS Adapter S-Press

 <b>1059397</b>	16-RS2	480	1	St. E1	<b>54,01</b>
--	--------	-----	---	-----------	--------------

## Uponor RS Adapter S-Press PLUS

 <b>1095818</b>	20-RS2	378	1	St. E1	<b>45,80</b>
<b>1095819</b>	25-RS2	378	1	St. E1	<b>45,80</b>
<b>1095820</b>	32-RS2	378	1	St. E1	<b>45,80</b>

## Uponor RS Adapter S-Press

 <b>1046940</b>	40-RS2	480	1	St. E1	<b>45,08</b>
<b>1046941</b>	50-RS2	480	1	St. E1	<b>47,34</b>
<b>1029125</b>	63-RS2	400	1	St. E1	<b>57,00</b>
<b>1029126</b>	75-RS2	400	1	St. E1	<b>87,67</b>
<b>1029127</b>	90-RS3	240	1	St. E1	<b>164,76</b>
<b>1029128</b>	110-RS3	240	1	St. E1	<b>198,46</b>

## Uponor RS Gewindeadapter Nippel

 <b>1059402</b>	R1 ½"MT-RS2	480	1	St. E1	<b>58,46</b>
<b>1029131</b>	R2"MT-RS2	480	1	St. E1	<b>58,07</b>
<b>1029132</b>	R2 ½"MT-RS2	480	1	St. E1	<b>86,46</b>
<b>1029133</b>	R3"MT-RS3	240	1	St. E1	<b>99,98</b>

## Uponor RS Gewindeadapter Muffe

 <b>1059403</b>	Rp½"FT-RS2	480	1	St. E1	<b>51,99</b>
<b>1029134</b>	Rp1"FT-RS2	480	1	St. E1	<b>56,90</b>
<b>1029135</b>	Rp2"FT-RS2	480	1	St. E1	<b>68,22</b>
<b>1029136</b>	Rp2 ½"FT-RS2	480	1	St. E1	<b>99,87</b>
<b>1059404</b>	Rp½"FT-RS3	336	1	St. E1	<b>72,92</b>
<b>1029137</b>	Rp3"FT-RS3	240	1	St. E1	<b>91,92</b>

## Uponor RS Flansch Adapter

 <b>1059398</b>	RS2-DN65 (PN6)	144	1	St. E1	<b>299,18</b>
<b>1059399</b>	RS2-DN65 (PN16)	90	1	St. E1	<b>353,94</b>
<b>1059400</b>	RS3-DN80 (PN6)	90	1	St. E1	<b>365,50</b>
<b>1029129</b>	RS3-DN80 (PN16)	90	1	St. E1	<b>384,64</b>
<b>1059401</b>	RS3-DN100 (PN6)	90	1	St. E1	<b>398,20</b>
<b>1029130</b>	RS3-DN100 (PN16)	90	1	St. E1	<b>418,43</b>

## Uponor RS Verriegelungselement

 <b>1042921</b>	RS2 black	5000	10	St. U2	<b>27,55</b>
<b>1042922</b>	RS3 grey	-	10	St. U2	<b>63,24</b>

Preis pro VPE

Installation

 Flächenheizung  
und -kühlung

 Nahwärme-  
versorgung

Werkzeuge

Anhang

# Flächenheizung/-kühlung

	Installationsart	System-Platten-dicke	Mindest-Aufbau-höhe* mm	Systemname	Beschreibung	Zugehörige Systemrohre	Dimension (mm)	
BODEN	NASSBAU	Noppenplattenverlegung, selbstklebend	—	15	<b>Uponor Minitec</b>	Sehr geringe Aufbauhöhe, direkt auf altem Untergrund (Estrich, Fliesen, Holz..)	<b>Comfort Pipe</b>	9,9
		Kletten	DES 25-2 30-2 30-3 35-3 WLS032 25-2	74	<b>Uponor Klett</b>	Mikroverzahnung von Systemplatte und Rohr. Schnelle Verlegeart, keine Beschädigung der Estrichfolie	<b>Klett Comfort Pipe PLUS Klett MLCP RED</b>	14, 16 16
		Kletten auf bauseitiger Dämmung	—	74	<b>Uponor Klett Twinboard</b>	Klettverlegung auf bauseitiger Dämmung mittels Hohlkammer-Verlegeplatten 3 mm	<b>Klett Comfort Pipe PLUS Klett MLCP RED</b>	14, 16 16
		Kletten inkl. Mineralwolle-Dämmung	30	74	<b>Uponor Klett Silent</b>	Klettverlegung auf Mineralwolleplatten, alternative Ausschreibungen	<b>Klett Comfort Pipe PLUS Klett MLCP RED</b>	14, 16 16
		Klett Vermeidung überheizte Flure	32	74	<b>Vario Heat Protect</b>	Rohrträger zur Führung von FBH-Anschlussleitungen unter der Heizestrichschicht	<b>alle Rohrleitungen zum Verteiler</b>	
		In der Noppenfolie	—	30	<b>Uponor Nubos</b>	Freie Wahl der Dämmschicht	<b>Comfort Pipe PLUS Blue Comfort Pipe Comfort Pipe PLUS MLCP RED</b>	16 16 14 14, 16
		In der Noppenplatte	11 oder 30-2	82	<b>Uponor Tecto</b>	Schnelle Rohrmontage, Systemplatten für Geschosstrenddecken, sicherer Halt	<b>Comfort Pipe PLUS Blue Comfort Pipe PLUS MLCP RED</b>	16 14, 17 14, 16
		In der Noppenplatte	11 oder 30-2	78	<b>Uponor Nubos</b>	Einfach in der Anwendung, normgerechte Verlegeabstände	<b>Comfort Pipe PLUS Blue Comfort Pipe Comfort Pipe PLUS MLCP RED</b>	16 16 14 14, 16
		Auf Stahlmatten mit Clip	—	83	<b>Uponor Classic</b>	Höchster Schallschutz (bauseitige Mineralwollämmung). Trennung der Gewerke Estrich/Heizung, große Heizkreise	<b>Comfort Pipe PLUS Blue Comfort Pipe PLUS Magna Pipe PLUS</b>	16, 20 17 20
		Tacker und U-Schiene	EPS DEO 20, 30 DES 20-2, 30-2, 30-3, 35-3, 40-3	75	<b>Uponor Tacker</b>	Preiswerteste Lösung. Unterschiedliche Wärme-/Trittschalldämmschichten lieferbar	<b>Comfort Pipe PLUS Blue Comfort Pipe MLCP RED</b>	16 16 14, 16
TROCKEN	In vorgeformte EPS-Platten und Alu-Wärmeleitlamellen	25	50	<b>Uponor Siccus 14</b>	Geringes Gewicht, sofort nutzbar, hohe Tragfähigkeit	<b>Comfort Pipe PLUS MLCP RED</b>	14 14	
	Mit vorgefertigten Kabelmatten, elektrische FBH	—	5	<b>Uponor Comfort E Kabelmatten</b>	Fest vernähte Kabelmatte, sehr geringe Aufbauhöhe, Verlegung auf nahezu allen festen Unterböden, inkl. Regler, schnelle Reaktion	—		

\* Systemplatte + Lastverteilschicht

# Uponor Systeme zum Heizen und Kühlen

		Installationsart	System-Plattendicke	Mindest-Aufbauhöhe* mm	Systemname	Beschreibung	Zugehörige Systemrohre	Dimension (mm)
<b>WAND</b>	<b>NASS</b>	Unter Putz, mit Klemmschiene	—	32	<b>Uponor Fix</b>	Effiziente und drallfreie Rohrverlegung von der Großrolle mit minimalem Verschnitt	<b>Comfort Pipe Comfort Pipe PLUS MLCP RED</b>	9,9 14 14
	<b>TROCKEN</b>	In vorgeformten EPS-Platten	25	30	<b>Uponor Siccus Wall</b>	Keine Trocknungszeiten und kein Funktionsheizen erforderlich	<b>Comfort Pipe PLUS MLCP RED</b>	14 14
		Auf CD-Profile 60/27, Gipspanel mit integrierten Heizrohren	—	15	<b>Uponor Renovis</b>	Faserverstärkte Gipsplatte 15 mm, Montage auf definierte Trockenbau-Unterkonstruktionen	<b>Comfort Pipe (integriert)</b>	9,9
<b>DECKE</b>	<b>NASS</b>	Unter Putz, mit Klemmschiene	—	32	<b>Uponor Fix</b>	Effiziente und drallfreie Rohrverlegung von der Großrolle mit minimalem Verschnitt	<b>Comfort Pipe</b>	9,9
	<b>TROCKEN</b>	Auf CD-Profile 60/27, Gipspanel mit integrierten Heizrohren	—	15	<b>Uponor Renovis</b>	Hohe Verlegeleistungen auf CD-Profilen	<b>Comfort Pipe (integriert)</b>	9,9
		Gipspanel inkl. EPS-Dämmung	27	27	<b>Uponor Teporis</b>	27 mm EPS Wärmedämmplatte	<b>Comfort Pipe (integriert)</b>	9,9
		Standard Unterkonstruktionen	—	15	<b>Uponor Thermatop M</b>	Fugen- und richtungslose Deckenoberflächen	<b>Uni Pipe PLUS</b>	16
<b>WEITERE ANWENDUNGEN</b>	<b>HALLEN</b>	<b>INDUSTRIEFLÄCHENHEIZUNG</b>						
		Auf Klemmschiene			<b>Uponor Magna</b>	Optimale Raumnutzung ohne störende Anlagenkomponenten	<b>Magna Pipe PLUS Comfort Pipe PLUS Blue</b>	20, 25 20
	Auf Stahlmatten							
	<b>TABS</b>	<b>BETONKERNAKTIVIERUNG</b>						
		Vorgefertigte Module auf Stahlmatte (Bewehrung)			<b>Uponor Contec</b>	Für die Einbringung in den Betonkern	<b>Magna Pipe PLUS</b>	20
		Oberflächennah			<b>Uponor Contec ON</b>	Diagonal verspannte Wabengitter mit vorbereiteten Rohren zum oberflächennahen Einbau in die Betonschalung	<b>Comfort Pipe PLUS Magna Pipe PLUS</b>	14 20
	<b>TROCKEN</b>	<b>SPORTBODEN</b>						
		In Sporthallen	30		<b>Uponor Siccus Sport</b>	Für flächenelastische Sportböden in Sandwichbauweise	<b>Comfort Pipe PLUS MLC weiß</b>	14 14
		In Sporthallen			<b>Uponor Sport</b>	Zum Einbau zwischen Unterzügen flächenelastischer Sportböden	<b>Magna Pipe PLUS</b>	25
	<b>FREIFLÄCHE</b>	<b>FREIFLÄCHENHEIZUNG / RASEN</b>						
Schnee- und Eisfreihaltung auf Freiflächen				<b>Uponor Meltaway</b>	Montage mit Klemmschiene, für sichere Gehwege z.B. vor Krankenhauseinfahrten, Hubschrauberlandeplätzen, Tiefgaragen- und Hofeinfahrten, Flugplätzen usw.	<b>Magna Pipe PLUS</b>	20, 25	

Installation

Flächenheizung und -kühlung

Nahwärmever-sorgung

Werkzeuge

Anhang

# Flächenheizung/-kühlung

## Uponor Heizrohre und Verbindungstechniken

Typ	Abmessung [mm]	Diffusionssperre	Rohrfarbe, Kennzeichnung	Druck [bar]	Temperatur [°C]	Länge [m]	Artikel-Nr.	DIN-Certco Zertifikat-Nr.
<b>Comfort Pipe PLUS</b> 	14 x 2,0	PE-Xa + EVOH Sperrschicht	weiß, 2 blaue Streifen	6	70	120 240 640 960	1062883 1062884 1088166 1062885	3V372
	17 x 2,0	PE-Xa + EVOH Sperrschicht	weiß, 2 blaue Streifen	6	70	120 240 480 640	1034535 1009226 1086340 1009227	3V372
	20 x 2,0	PE-Xa + EVOH Sperrschicht	weiß, 2 blaue Streifen	6	70	60	1009229	3V372
<b>Comfort Pipe PLUS Blue</b> 	16 x 2,0	PE-Xa + EVOH Sperrschicht	weiß, 2 blaue Streifen	6	70	640	1126541	3V372 ISCC-zertifiziert
	20 x 2,0	PE-Xa + EVOH Sperrschicht	weiß, 2 blaue Streifen	6	70	480	1126542	3V372 ISCC-zertifiziert
<b>Klett Comfort Pipe PLUS</b> 	14 x 2,0	PE-Xa + EVOH Sperrschicht	weiß, 2 blaue Streifen, mit Klettband	6	70	240 640	1088479 1088480	3V372
	16 x 2,0	PE-Xa + EVOH Sperrschicht	weiß, 2 blaue Streifen, mit Klettband	6	70	240 640	1087302 1087303	3V372
<b>Magna Pipe PLUS</b> 	20 x 2,0	PE-Xa + EVOH Sperrschicht	weiß, 2 blaue Streifen	6	70	240 480	1091275 1091276	3V415
	25 x 2,3	PE-Xa + EVOH Sperrschicht	weiß, 2 blaue Streifen	6	70	300 640	1091277 1091278	3V415
<b>Comfort Pipe</b> 	16 x 1,8	PE-Xa + EVOH Sperrschicht	weiß, 1 blauer Streifen	6	70	240 640	1047622 1047623	3V417
<b>Minitec Comfort Pipe</b> 	9,9 x 1,1	PE-Xa + EVOH Sperrschicht	natur, 1 blauer Streifen	6	70	60 120 480	1063287 1063288 1063381	3V279
<b>MLC Rohr weiß</b> 	14 x 2,0	Verbundrohr mit AL	weiß	10	80	200	1013366	
<b>MLCP RED</b> 	14 x 1,6	Verbundrohr mit AL	rot, innen blau	4	60	240 480	1096010 1096011	3V286
	16 x 2,0	Verbundrohr mit AL	rot, innen blau	4	60	240 480	1096012 1096013	3V286
<b>MLCP RED Klett</b> 	16 x 2,0	Verbundrohr mit AL	weiß, innen blau, 2 rote Streifen, mit Klettband	4	60	240 480	1096014 1096015	3V286

## Verbindungstechnik, Fittings und Werkzeug für Flächenheizsysteme

(Klemmring-) Verschraubungen



Maulschlüssel handelsüblich



Quick und Easy Fittings



Q+E-Aufweitwerkzeuge



zugehörige Q+E-Sicherungsringe



rapex Pressfittings



rapex Pressbacken



Smart Presskupplungen



Pressbacken MLC UPP1 und KSP0



S-Press und S-Press-PLUS Kupplungen



Vario/Fit 14x2,0	M12 & M18	natur eval	14	14	-
Vario/Fit 17x2,0	M12 & M18	natur eval & weiß	17	-	-
Vario/Fit 20x1,9/2,0	M12 & M18	natur eval & weiß	-	20	-
Vario/Fit 16x1,8/2,0	M12 & M18	natur eval & weiß	16	16	-
Vario/Fit 20x1,9/2,0	M12 & M18	natur eval & weiß	-	20	-
Vario/Fit 14x2,0	M12 & M18	natur eval	14	14	-
Vario/Fit 16x1,8/2,0	M12 & M18	natur eval & weiß	16	16	-
Vario/Fit 20x1,9/2,0	M12 & M18	natur eval & weiß	-	20	-
Vario/Fit 25x2,3	M12 & M18	natur eval & weiß	25	-	-
Vario/Fit 16x1,8/2,0	M12 & M18	natur eval & weiß	16	16	-
Vario & Minitec 9,9 x 1,1	Hand, M12 & M18	Minitec PEX	-	-	-
Uni-X 14-3/4 Euro	-	-	-	-	14
Vario MLCP RED 14x1,6 Euro	-	-	-	-	14 MLCP RED Press-Kupplung
Uni-X 16-3/4 Euro	-	-	-	-	16
Uni-X 16-3/4 Euro	-	-	-	-	16

Installation













Flächenheizung und -kühlung













Nahwärmeversorgung

Werkzeuge

Anhang

# Uponor Minitec

Art-Nr.	Dimension	LE	VE	ME RG	Preis/ME
<b>Uponor Minitec Folienelement</b>					
 <b>1005261</b>	15,4m <sup>2</sup> 9,9x1,1 1100x700x12mm	123,2	15,4	m <sup>2</sup> M <sup>2</sup>	<b>41,33</b>
<b>Uponor Fix Klemmschiene</b>					
 <b>1005274</b>	9,9mm c/c20mm 2,5m	25	2,5	m M <sup>2</sup>	<b>7,19</b>
<b>Uponor Minitec Randdämmstreifen selbstklebend</b>					
 <b>1005267</b>	20m 80x8mm	200	20	m M <sup>2</sup>	<b>1,90</b>
<b>Uponor Minitec Bewegungsfugenprofil</b>					
 <b>1085980</b>	0,9m 40x10mm	600	10	St. M <sup>2</sup>	<b>12,53</b>
<b>1085981</b>	1,3m 40x10mm	600	10	St. M <sup>2</sup>	<b>15,88</b>
<b>Uponor Comfort Pipe Rohr Minitec</b>					
 <b>1063287</b>	9,9x1,1 60m	840	60	m M <sup>2</sup>	<b>4,11</b>
<b>1063288</b>	9,9x1,1 120m	1680	120	m M <sup>2</sup>	<b>4,11</b>
<b>1063381</b>	9,9x1,1 480m	2880	480	m M <sup>2</sup>	<b>4,11</b>
<b>Uponor Minitec Schutzhülse</b>					
 <b>1005269</b>	9,9mm 300x2mm	3600	30	St. M <sup>2</sup>	<b>2,27</b>
<b>Uponor Minitec Eurokonusverschraubung</b>					
 <b>1005266</b>	9,9x1,1-G $\frac{3}{4}$ "Euro	100	10	St. M <sup>2</sup>	<b>12,91</b>
<b>Uponor Minitec Kupplung</b>					
 <b>1005264</b>	9,9x1,1	100	10	St. M <sup>2</sup>	<b>11,19</b>
<b>Uponor Minitec Übergangsnippel</b>					
 <b>1005265</b>	9,9-R $\frac{1}{2}$ "MT	100	10	St. M <sup>2</sup>	<b>13,73</b>
<b>Uponor Minitec Ring</b>					
 <b>1005263</b>	9,9x1,1	1600	10	St. M <sup>2</sup>	<b>0,74</b>
<b>Uponor Minitec Klemmringverschraubung</b>					
 <b>1013426</b>	9,9- $\frac{3}{4}$ "Euro	120	12	St. M <sup>2</sup>	<b>21,64</b>
<b>Uponor Minitec Schraubkupplung</b>					
 <b>1016690</b>	9,9-9,9	48	12	St. M <sup>2</sup>	<b>51,48</b>
<b>Uponor Fluvia Hosenstück</b>					
 <b>1005675</b>	2xG $\frac{3}{4}$ - $\frac{3}{4}$ "Euro	50	1	Set MZ	<b>48,72</b>

Art-Nr.	Dimension	LE	VE	ME RG	Preis/ME
<b>Uponor Fluvia T Pumpengruppe Push-12 TH-G</b>					
 <b>1095127</b>		60	1	St. MZ	<b>794,71</b>
<b>Uponor Fluvia T Pumpengruppe Push-12 CH-G</b>					
 <b>1095131</b>		30	1	St. MZ	<b>1870,88</b>
<b>Uponor Fluvia T Pumpengruppe Push-12 AC-G</b>					
 <b>1095128</b>		60	1	St. MZ	<b>942,45</b>
<b>Uponor Fluvia T Pumpengruppe Push-12 WL-G</b>					
 <b>1095130</b>		60	1	St. MZ	<b>1258,84</b>
<b>Uponor Vario Füll / Entleerungshahn</b>					
 <b>1061802</b>	$\frac{3}{4}$ " - $\frac{3}{4}$ "	10	1	Set MZ	<b>75,81</b>
<b>Uponor Multi Rohrführungsbogen</b>					
 <b>NEU 1135490</b>	10-12	360	60	St. D1	<b>1,48</b>
<b>Uponor Minitec Anschlussbox-UP</b>					
 <b>1005270</b>	1X	30	1	St. M <sup>2</sup>	<b>402,89</b>
<b>1005271</b>	2X	-	1	St. M <sup>2</sup>	<b>564,07</b>
<b>1005272</b>	3X	-	1	St. M <sup>2</sup>	<b>595,41</b>
<i>Die Begrenzung der Auslegungstemperatur muss durch eine Vorregelung sichergestellt sein.</i>					
<b>Uponor Minitec Abdeckplatte</b>					
 <b>1007251</b>		-	1	St. M <sup>2</sup>	<b>164,16</b>
<b>Uponor Base Raumfühler T-23</b>					
 <b>1058422</b>	230V RAL9010	160	1	St. MZ	<b>57,25</b>
<b>Uponor Minitec Aufweitwerkzeug</b>					
 <b>1006247</b>	9,9x1,1	11	1	Set NET	<b>390,93</b>
<b>Uponor Q&amp;E Aufweitwerkzeug mit Aufweitk. M12</b>					
 <b>OUT 1063112</b>	6BAR 9,9/20	-	1	Set NET	<b>661,08</b>
<i>Lieferung solange Vorrat reicht. Artikel läuft im Laufe des Jahres aus.</i>					
<b>Uponor Q&amp;E Aufweitwerkzeug mit Aufweitk. M12/</b>					
 <b>1119375</b>	6bar 9,9RS/20	-	1	Set NET	<b>687,02</b>

# Uponor Tecto

Art-Nr.	Dimension	LE	VE	ME RG	Preis/ME
---------	-----------	----	----	----------	----------

## Uponor Tecto Noppenplatte

 <b>1005478</b>	EPS DES 30-2mm 14-17mm 1450x850mm	53,76	8,96	m <sup>2</sup> M4	<b>29,39</b>
<b>1005477</b>	EPS 11mm 14-17mm 1450x850mm	94,08	15,68	m <sup>2</sup> M4	<b>27,00</b>

## Uponor Tecto Diagonal-Rohrfixierung

 <b>1005482</b>	45deg 75mm	420	10	St. M4	<b>2,46</b>
--	------------	-----	----	-----------	-------------

## Uponor Tecto Zwillingstreifen

 <b>1005484</b>	1,4m 100mm	742,5	33,75	m M4	<b>4,45</b>
--	------------	-------	-------	---------	-------------

## Uponor Tecto Abdeckfolie

 <b>1005481</b>	1,45m 200mm	504	28	m M4	<b>4,70</b>
--	-------------	-----	----	---------	-------------

## Uponor Tecto Dämmstreifen

 <b>1005480</b>	EPS DES 30-2mm 150x1400mm	268,8	8,4	m M4	<b>6,90</b>
<b>1005479</b>	EPS 11mm 150x1400mm	716,8	22,4	m M4	<b>6,08</b>

## Uponor Multi Randdämmstreifen mit Folie

 <b>1000079</b>	150x8mm	-	200	m MZ	<b>1,51</b>
---	---------	---	-----	---------	-------------

*Hinweis: Verkauf pro Verpackungseinheit.*

## Uponor Multi Randdämmstreifen mit Klebefolie

 <b>1000080</b>	150x10mm	-	200	m MZ	<b>3,08</b>
--	----------	---	-----	---------	-------------

*Hinweis: Verkauf pro Verpackungseinheit.*

## Uponor Multi PE Randdämmstreifen mit Klebefolie HB

 <b>NEU 1135494</b>	150x8mm	-	250	m MZ	<b>1,51</b>
--	---------	---	-----	---------	-------------

## Uponor Multi Dehnungsfugenprofil

 <b>1090229</b>	1800x100x10mm	720	18	m MZ	<b>14,14</b>
--	---------------	-----	----	---------	--------------

## Uponor Multi Schutzhülse

 <b>1000082</b>	20mm 300x5mm	1800	30	St. MZ	<b>1,37</b>
--	--------------	------	----	-----------	-------------

## Uponor Comfort Pipe PLUS Blue Rohr

 <b>1126541</b>	16x2,0 640m	640	640	m M0	<b>4,24</b>
--	-------------	-----	-----	---------	-------------

Art-Nr.	Dimension	LE	VE	ME RG	Preis/ME
---------	-----------	----	----	----------	----------

## Uponor Comfort Pipe PLUS Rohr

 <b>1062883</b>	14x2,0 120m	1320	120	m M0	<b>3,39</b>
<b>1062884</b>	14x2,0 240m	1680	240	m M0	<b>3,39</b>
<b>1088166</b>	14x2,0 640m	1920	640	m M0	<b>3,39</b>
<b>1062885</b>	14x2,0 960m	1920	960	m M0	<b>3,39</b>
<b>1034535</b>	17x2,0 120m	840	120	m M0	<b>3,56</b>
<b>1009226</b>	17x2,0 240m	1200	240	m M0	<b>3,56</b>
<b>1086340</b>	17x2,0 480m	960	480	m M0	<b>3,56</b>
<b>1009227</b>	17x2,0 640m	1280	640	m M0	<b>3,56</b>

## Uponor Vario Klemmringverschraubung PEX

 <b>1065283</b>	14x2,0-G¾"FT Euro	25	1	St. MZ	<b>7,88</b>
<b>1065284</b>	16x1,8/2,0-G¾"FT Euro	25	1	St. MZ	<b>7,88</b>
<b>1065286</b>	17x2,0-G¾"FT Euro	25	1	St. MZ	<b>7,88</b>

## Uponor Fit Schraubkupplung PEX

 <b>1065296</b>	16x1,8/2,0-16x1,8/2,0	25	1	St. MZ	<b>25,59</b>
<b>1065299</b>	17x2,0-17x2,0	25	1	St. MZ	<b>24,32</b>

## Uponor Fit Übergangverschraubung PEX

 <b>1065294</b>	14x2,0-R½"MT	25	1	St. MZ	<b>19,77</b>
<b>1065297</b>	16x1,8/2,0-R½"MT	25	1	St. MZ	<b>20,83</b>
<b>1065300</b>	17x2,0-R½"MT	25	1	St. MZ	<b>17,09</b>

## Uponor Fit Übergangverschraubung PEX

 <b>1065295</b>	14x2,0-Rp½"FT	25	1	St. MZ	<b>20,60</b>
<b>1065298</b>	16x1,8/2,0-Rp½"FT	25	1	St. MZ	<b>19,84</b>

## Uponor Rapex Press-Kupplung

 <b>1005079</b>	17-17	100	10	St. MZ	<b>15,61</b>
--	-------	-----	----	-----------	--------------

## Uponor Q&E Kupplung m. Ringen DR

 <b>1058659</b>	14-14	100	10	St. MZ	<b>7,91</b>
<b>1058660</b>	16x1,8/2,0-16x1,8/2,0	100	10	St. MZ	<b>9,57</b>
<b>1058661</b>	17-17	100	10	St. MZ	<b>11,33</b>

## Uponor Q&E Ring natural, eval

 <b>1058428</b>	14	900	20	St. MZ	<b>0,46</b>
--	----	-----	----	-----------	-------------

## Uponor Smart Presskupplung

 <b>1089646</b>	14x2,0-14x2,0	80	20	St. MZ	<b>11,75</b>
<b>1089647</b>	16x1,8/2,0-16x1,8/2,0	80	20	St. MZ	<b>13,30</b>



# Uponor Tecto

Art-Nr.	Dimension	LE	VE	ME RG	Preis/ME
 <b>1096010</b>	14x1,6 240m	3120	240	m M1	<b>2,02</b>
<b>1096011</b>	14x1,6 480m	3360	480	m M1	<b>2,02</b>
<b>1096012</b>	16x2,0 240m	3120	240	m M1	<b>2,52</b>
<b>1096013</b>	16x2,0 480m	3360	480	m M1	<b>2,52</b>

## Uponor Vario Eurokonusverschraubung MLCP RED

 <b>1000117</b>	14x1,6-¾" Euro	80	20	St. MZ	<b>6,80</b>
--	----------------	----	----	-----------	-------------

## Uponor MLCP RED Press-Kupplung

 <b>1048272</b>	14x1,6-14x1,6	80	20	St. MZ	<b>12,58</b>
--	---------------	----	----	-----------	--------------

## Uponor S-Press PLUS Kupplung

 <b>1070547</b>	16-16	80	20	St. D1	<b>11,76</b>
--	-------	----	----	-----------	--------------

Art-Nr.	Dimension	LE	VE	ME RG	Preis/ME
---------	-----------	----	----	----------	----------

## Uponor S-Press PLUS Kupplung PPSU

 <b>1039933</b>	16-16	80	20	St. E1	<b>7,39</b>
--	-------	----	----	-----------	-------------

## Uponor Uni-X Verschraubung MLC

 <b>1058090</b>	16-¾" FT Euro	25	1	St. D1	<b>9,20</b>
--	---------------	----	---	-----------	-------------

## Uponor Multi Rohrführungsbogen

 <b>1135491</b>	14-18	240	30	St. D1	<b>3,79</b>
--	-------	-----	----	-----------	-------------

# Uponor Nubos

## Uponor Nubos Noppenplatte

 <b>1016699</b>	EPS 30-2 14-16mm 1447x900x48mm	60	10	m <sup>2</sup> M4	<b>28,20</b>
<b>1016700</b>	EPS 11 14-16mm 1447x900x29mm	100	10	m <sup>2</sup> M4	<b>26,35</b>

## Uponor Nubos Noppenfolie

 <b>1016703</b>	14-16mm	140	10	m <sup>2</sup> M9	<b>15,57</b>
<b>1061880</b>	14-16mm	-	200	m <sup>2</sup> M9	<b>14,84</b>

## Uponor Nubos Noppen-Verteiler-/Tür Set

 <b>1016701</b>	EPS 30-2 14-16mm 1447x900x48mm	50	5	m <sup>2</sup> M4	<b>32,98</b>
<b>1016702</b>	EPS 11 14-16mm 1447x900x29mm	50	5	m <sup>2</sup> M4	<b>29,62</b>

## Uponor Multi Randdämmstreifen mit Folie

 <b>1000079</b>	150x8mm	-	200	m MZ	<b>1,51</b>
--	---------	---	-----	---------	-------------

Hinweis: Verkauf pro Verpackungseinheit.

## Uponor Multi Randdämmstreifen Klebefolie

 <b>1000080</b>	150x10mm	-	200	m MZ	<b>3,08</b>
--	----------	---	-----	---------	-------------

Hinweis: Verkauf pro Verpackungseinheit.

## Uponor Multi PE Randdämmstreifen mit Klebefolie HB

 <b>NEU 1135494</b>	150x8mm	-	250	m MZ	<b>1,51</b>
--	---------	---	-----	---------	-------------

## Uponor Multi Dehnungsfugenprofil

 <b>1090229</b>	1800x100x10mm	720	18	m MZ	<b>14,14</b>
--	---------------	-----	----	---------	--------------

## Uponor Multi Schutzhülse

 <b>1000082</b>	20mm 300x5mm	1800	30	St. MZ	<b>1,37</b>
--	--------------	------	----	-----------	-------------

## Uponor Comfort Pipe PLUS Blue Rohr

 <b>1126541</b>	16x2,0 640m	640	640	m M0	<b>4,24</b>
--	-------------	-----	-----	---------	-------------

## Uponor Comfort Pipe PLUS Rohr

 <b>1088166</b>	14x2,0 640m	1920	640	m M0	<b>3,39</b>
--	-------------	------	-----	---------	-------------

## Uponor Comfort Pipe Rohr

 <b>1047622</b>	16x1,8 240m	1440	240	m M1	<b>1,70</b>
<b>1047623</b>	16x1,8 640m	1280	640	m M1	<b>1,70</b>

## Uponor Vario Klemmringverschraubung PEX

 <b>1065283</b>	14x2,0-0-G¾" FT Euro	25	1	St. MZ	<b>7,88</b>
<b>1065284</b>	16x1,8/2,0-0-G¾" FT Euro	25	1	St. MZ	<b>7,88</b>



# Uponor Nubos

Art-Nr.	Dimension	LE	VE	ME RG	Preis/ME
---------	-----------	----	----	----------	----------

## Uponor Smart Presskupplung

 <b>1089646</b>	14x2,0-14x2,0	80	20	St. MZ	<b>11,75</b>
<b>1089647</b>	16x1,8/2,0-16x1,8/2,0	80	20	St. MZ	<b>13,30</b>

## Uponor MLCP RED Rohr

 <b>1096010</b>	14x1,6 240m	3120	240	m M1	<b>2,02</b>
<b>1096011</b>	14x1,6 480m	3360	480	m M1	<b>2,02</b>
<b>1096012</b>	16x2,0 240m	3120	240	m M1	<b>2,52</b>
<b>1096013</b>	16x2,0 480m	3360	480	m M1	<b>2,52</b>

## Uponor Vario Eurokonusverschraubung MLCP RED

 <b>1000117</b>	14x1,6-¾" Euro	80	20	St. MZ	<b>6,80</b>
--	----------------	----	----	-----------	-------------

## Uponor MLCP RED Press-Kupplung

 <b>1048272</b>	14x1,6-14x1,6	80	20	St. MZ	<b>12,58</b>
--	---------------	----	----	-----------	--------------

Art-Nr.	Dimension	LE	VE	ME RG	Preis/ME
---------	-----------	----	----	----------	----------

## Uponor Uni-X Verschraubung MLC

 <b>1058090</b>	16-¾" FT Euro	25	1	St. D1	<b>9,20</b>
--	---------------	----	---	-----------	-------------

## Uponor S-Press PLUS Kupplung

 <b>1070547</b>	16-16	80	20	St. D1	<b>11,76</b>
--	-------	----	----	-----------	--------------

## Uponor S-Press PLUS Kupplung PPSU

 <b>1039933</b>	16-16	80	20	St. E1	<b>7,39</b>
--	-------	----	----	-----------	-------------

## Uponor Multi Rohrführungsbogen

 <b>1135491</b>	14-18	240	30	St. D1	<b>3,79</b>
--	-------	-----	----	-----------	-------------

# Uponor Klett

## Uponor Klett Rollplatte extra

 <b>1063402</b>	EPS DES 25-2mm 10x1m	80	10	m <sup>2</sup> M6	<b>15,99</b>
<b>1063322</b>	EPS DES 30-2mm 10x1m	80	10	m <sup>2</sup> M6	<b>18,57</b>
<b>1063323</b>	EPS DES 30-3mm 10x1m	80	10	m <sup>2</sup> M6	<b>16,36</b>
<b>1063324</b>	EPS DES 35-3mm 10x1m	70	10	m <sup>2</sup> M6	<b>17,28</b>

## Uponor Klett Rollplatte

 <b>1085788</b>	G EPS DES WLS032 25-2mm 10x1m	80	10	m <sup>2</sup> M6	<b>18,21</b>
--	----------------------------------	----	----	----------------------	--------------

## Uponor Klett Twinboard

 <b>1086854</b>	2400x1000x3mm	360	24	m <sup>2</sup> M6	<b>23,23</b>
--	---------------	-----	----	----------------------	--------------

## Uponor Klett Panel Silent

 <b>1088065</b>	1200x1000x30mm	48	4,8	m <sup>2</sup> M6	<b>60,23</b>
--	----------------	----	-----	----------------------	--------------

## Uponor Vario Verteilerplatte

 <b>1090043</b>	27mm	116	29	St. MZ	<b>59,23</b>
--	------	-----	----	-----------	--------------

## Uponor Vario Rohrführungsplatte

 <b>1090044</b>	27mm	116	29	St. MZ	<b>53,16</b>
--	------	-----	----	-----------	--------------

## Uponor Vario Verteilerpl. m. Trittschall

 <b>1091816</b>	32mm	100	25	St. MZ	<b>84,12</b>
--	------	-----	----	-----------	--------------

## Uponor Vario Rohrführung m. Trittschall

 <b>1091817</b>	32mm	100	25	St. MZ	<b>70,47</b>
--	------	-----	----	-----------	--------------

Installation

Flächenheizung  
und -kühlungNahwärme-  
versorgung

Werkzeuge

Anhang

# Uponor Klett

Art-Nr.	Dimension	LE	VE	ME RG	Preis/ME
---------	-----------	----	----	----------	----------

## Uponor Multi Randdämmstreifen mit Folie

 <b>1000079</b>	150x8mm	-	200	m MZ	<b>1,51</b>
--	---------	---	-----	---------	-------------

*Hinweis: Verkauf pro Verpackungseinheit.*

## Uponor Multi Randdämmstreifen Klebefolie

 <b>1000080</b>	150x10mm	-	200	m MZ	<b>3,08</b>
--	----------	---	-----	---------	-------------

*Hinweis: Verkauf pro Verpackungseinheit.*

## Uponor Multi PE Randdämmstreifen mit Klebefolie HB

 <b>NEU 1135494</b>	150x8mm	-	250	m MZ	<b>1,51</b>
--	---------	---	-----	---------	-------------

## Uponor Klett Randdämmstreifen

 <b>1089919</b>	1200X120X13mm	1536	96	m M6	<b>6,77</b>
--	---------------	------	----	---------	-------------

## Uponor Klett Abdichtstreifen

 <b>1089951</b>	50m 280x0,2mm	6000	50	m M6	<b>7,62</b>
--	---------------	------	----	---------	-------------

## Uponor Multi Dehnungsfugenprofil

 <b>1090229</b>	1800x100x10mm	720	18	m MZ	<b>14,14</b>
--	---------------	-----	----	---------	--------------

## Uponor Multi Schutzhülse

 <b>1000082</b>	20mm 300x5mm	1800	30	St. MZ	<b>1,37</b>
--	--------------	------	----	-----------	-------------

## Uponor Klett Rohr Comfort Pipe PLUS

 <b>1088479</b>	14x2,0 240m	1440	240	m M6	<b>2,62</b>
<b>1088480</b>	14x2,0 640m	1280	640	m M6	<b>2,62</b>
<b>1087302</b>	16x2,0 240m	1200	240	m M6	<b>2,74</b>
<b>1087303</b>	16x2,0 640m	1280	640	m M6	<b>2,74</b>

## Uponor Vario Klemmringverschraubung PEX

 <b>1065283</b>	14x2,0-G¾"FT Euro	25	1	St. MZ	<b>7,88</b>
<b>1065284</b>	16x1,8/2,0-G¾"FT Euro	25	1	St. MZ	<b>7,88</b>

## Uponor Smart Presskupplung

 <b>1089646</b>	14x2,0-14x2,0	80	20	St. MZ	<b>11,75</b>
<b>1089647</b>	16x1,8/2,0-16x1,8/2,0	80	20	St. MZ	<b>13,30</b>

## Uponor Fit Schraubkupplung PEX

 <b>1065296</b>	16x1,8/2,0-16x1,8/2,0	25	1	St. MZ	<b>25,59</b>
--	-----------------------	----	---	-----------	--------------

## Uponor Fit Übergangverschraubung PEX

 <b>1065294</b>	14x2,0-R½"MT	25	1	St. MZ	<b>19,77</b>
<b>1065297</b>	16x1,8/2,0-R½"MT	25	1	St. MZ	<b>20,83</b>

Art-Nr.	Dimension	LE	VE	ME RG	Preis/ME
---------	-----------	----	----	----------	----------

## Uponor Fit Übergangverschraubung PEX

 <b>1065295</b>	14x2,0-Rp½"FT	25	1	St. MZ	<b>20,60</b>
<b>1065298</b>	16x1,8/2,0-Rp½"FT	25	1	St. MZ	<b>19,84</b>

## Uponor Q&E Kupplung m. Ringen DR

 <b>1058659</b>	14-14	100	10	St. MZ	<b>7,91</b>
<b>1058660</b>	16x1,8/2,0-16x1,8/2,0	100	10	St. MZ	<b>9,57</b>

## Uponor Q&E Ring natural, eval

 <b>1058428</b>	14	900	20	St. MZ	<b>0,46</b>
--	----	-----	----	-----------	-------------

## Uponor Q&E Sicherungsring white

 <b>1057453</b>	16	900	20	St. F1	<b>0,49</b>
--	----	-----	----	-----------	-------------

## Uponor Klett Rohr MLCP RED

 <b>1096014</b>	16X2,0 240M	1920	240	m M6	<b>3,12</b>
<b>1096015</b>	16X2,0 480M	2400	480	m M6	<b>3,12</b>

## Uponor Uni-X Verschraubung MLC

 <b>1058090</b>	16-¾"FT Euro	25	1	St. D1	<b>9,20</b>
--	--------------	----	---	-----------	-------------

## Uponor S-Press PLUS Kupplung

 <b>1070547</b>	16-16	80	20	St. D1	<b>11,76</b>
--	-------	----	----	-----------	--------------

## Uponor S-Press PLUS Kupplung PPSU

 <b>1039933</b>	16-16	80	20	St. E1	<b>7,39</b>
--	-------	----	----	-----------	-------------

## Uponor Klett mit Klebeband spezial

 <b>1007178</b>	20m 50mm	30	5	St. U1	<b>26,64</b>
--	----------	----	---	-----------	--------------

## Uponor Multi Klebeband

 <b>1000012</b>	66m 50mm	36	1	St. MZ	<b>8,25</b>
--	----------	----	---	-----------	-------------

## Uponor Multi Klebebandabroller

 <b>1000142</b>		20	1	St. NET	<b>30,97</b>
--	--	----	---	------------	--------------

## Uponor Multi Rohrführungsbogen

 <b>1135491</b>	14-18	240	30	St. D1	<b>3,79</b>
--	-------	-----	----	-----------	-------------

## Uponor Multi Rohrhalterung

 <b>1088066</b>		-	1	St. NET	<b>293,79</b>
--	--	---	---	------------	---------------

# Uponor Tacker

Art-Nr.	Dimension	LE	VE	ME RG	Preis/ME
 <b>1090921</b>	EPS DES 20-2mm 10x1m	100	10	m <sup>2</sup> M7	<b>11,60</b>
<b>1090924</b>	EPS DES 30-2mm 10x1m	80	10	m <sup>2</sup> M7	<b>13,87</b>
<b>1090925</b>	EPS DES 30-3mm 10x1m	80	10	m <sup>2</sup> M7	<b>12,64</b>
<b>1090926</b>	EPS DES 35-3mm 10x1m	70	10	m <sup>2</sup> M7	<b>13,99</b>
<b>1090927</b>	EPS DES 40-3mm 10x1m	60	10	m <sup>2</sup> M7	<b>15,21</b>

## Uponor Tacker Panel

 <b>1090917</b>	EPS DEO 20	100	10	m <sup>2</sup> M7	<b>12,27</b>
<b>1090918</b>	EPS DEO 30	80	10	m <sup>2</sup> M7	<b>22,33</b>

## Uponor Tacker Folie transparent

 <b>1122372</b>	0,2mm 100x1,03m	2884	103	m <sup>2</sup> M7	<b>4,97</b>
--	-----------------	------	-----	----------------------	-------------

## Uponor Multi Randdämmstreifen mit Folie

 <b>1000079</b>	150x8mm	-	200	m MZ	<b>1,51</b>
--	---------	---	-----	---------	-------------

*Hinweis: Verkauf pro Verpackungseinheit.*

## Uponor Multi Randdämmstreifen mit Klebefolie

 <b>1000080</b>	150x10mm	-	200	m MZ	<b>3,08</b>
--	----------	---	-----	---------	-------------

*Hinweis: Verkauf pro Verpackungseinheit.*

## Uponor Multi PE Randdämmstreifen mit Klebefolie HB

 <b>NEU 1135494</b>	150x8mm	-	250	m MZ	<b>1,51</b>
--	---------	---	-----	---------	-------------

## Uponor Multi Dehnungsfugenprofil

 <b>1090229</b>	1800x100x10mm	720	18	m MZ	<b>14,14</b>
--	---------------	-----	----	---------	--------------

## Uponor Multi Schutzhülse

 <b>1000082</b>	20mm 300x5mm	1800	30	St. MZ	<b>1,37</b>
--	--------------	------	----	-----------	-------------

## Uponor Multi Klebeband

 <b>1000012</b>	66m 50mm	36	1	St. MZ	<b>8,25</b>
--	----------	----	---	-----------	-------------

## Uponor Multi Klebebandabroller

 <b>1000142</b>		20	1	St. NET	<b>30,97</b>
--	--	----	---	------------	--------------

Art-Nr.	Dimension	LE	VE	ME RG	Preis/ME
---------	-----------	----	----	----------	----------

## Uponor Comfort Pipe Rohr

 <b>1047622</b>	16x1,8 240m	1440	240	m M1	<b>1,70</b>
<b>1047623</b>	16x1,8 640m	1280	640	m M1	<b>1,70</b>

## Uponor Comfort Pipe PLUS Blue Rohr

 <b>1126541</b>	16x2,0 640m	640	640	m M0	<b>4,24</b>
--	-------------	-----	-----	---------	-------------

## Uponor Vario Klemmringverschraubung PEX

 <b>1065284</b>	16x1,8/2,0-G $\frac{3}{4}$ "FT Euro	25	1	St. MZ	<b>7,88</b>
--	-------------------------------------	----	---	-----------	-------------

## Uponor Fit Schraubkupplung PEX

 <b>1065296</b>	16x1,8/2,0-16x1,8/2,0	25	1	St. MZ	<b>25,59</b>
--	-----------------------	----	---	-----------	--------------

## Uponor Smart Presskupplung

 <b>1089647</b>	16x1,8/2,0-16x1,8/2,0	80	20	St. MZ	<b>13,30</b>
--	-----------------------	----	----	-----------	--------------

## Uponor MLCP RED Rohr

 <b>1096010</b>	14x1,6 240m	3120	240	m M1	<b>2,02</b>
<b>1096011</b>	14x1,6 480m	3360	480	m M1	<b>2,02</b>
<b>1096012</b>	16x2,0 240m	3120	240	m M1	<b>2,52</b>
<b>1096013</b>	16x2,0 480m	3360	480	m M1	<b>2,52</b>

## Uponor Vario Eurokonusverschraubung MLCP RED

 <b>1000117</b>	14x1,6- $\frac{3}{4}$ "Euro	80	20	St. MZ	<b>6,80</b>
--	-----------------------------	----	----	-----------	-------------

## Uponor MLCP RED Press-Kupplung

 <b>1048272</b>	14x1,6-14x1,6	80	20	St. MZ	<b>12,58</b>
--	---------------	----	----	-----------	--------------

## Uponor Uni-X Verschraubung MLC

 <b>1058090</b>	16- $\frac{3}{4}$ "FT Euro	25	1	St. D1	<b>9,20</b>
--	----------------------------	----	---	-----------	-------------

## Uponor S-Press PLUS Kupplung

 <b>1070547</b>	16-16	80	20	St. D1	<b>11,76</b>
--	-------	----	----	-----------	--------------

## Uponor S-Press PLUS Kupplung PPSU

 <b>1039933</b>	16-16	80	20	St. E1	<b>7,39</b>
--	-------	----	----	-----------	-------------

Installation

Flächenheizung  
und -kühlungNahwärme-  
versorgung

Werkzeuge

Anhang

# Uponor Tacker

Art-Nr.	Dimension	LE	VE	ME RG	Preis/ME
---------	-----------	----	----	----------	----------

## Uponor Tacker Tackernadel kurz

 <b>NEU</b> 1135487	14-17mm h=35mm	8400	300	St. M7	0,18
--	----------------	------	-----	-----------	------

## Uponor Tacker Nadel

 1086529	14-20mm h=40mm	8000	1000	St. M7	0,08
---	----------------	------	------	-----------	------

## Uponor Tacker Tackernadel lang

 <b>NEU</b> 1135489	14-20mm h=50mm	5000	250	St. M7	0,37
--	----------------	------	-----	-----------	------

Art-Nr.	Dimension	LE	VE	ME RG	Preis/ME
---------	-----------	----	----	----------	----------

## Uponor Tacker Werkzeug

 1119039	14-20mm	50	1	St. NET	274,65
---	---------	----	---	------------	--------

## Uponor Multi Rohrführungsbogen

 1135491	14-18	240	30	St. D1	3,79
1135492	20-22	140	35	St. D1	4,67

# Uponor Fix

## Uponor Fix Klemmschiene mit Klebestreifen

 <b>NEU</b> 1135496	16-20mm c/c 50mm 1m	2000	100	St. M <sup>3</sup>	7,07
--	---------------------	------	-----	-----------------------	------

## Uponor Fix Klemmschiene

 1005498	14mm c/c50mm 2,5m	-	25	m M <sup>3</sup>	5,71
---	-------------------	---	----	---------------------	------

## Uponor Fix Klemmschiene

 1005274	9,9mm c/c20mm 2,5m	25	2,5	m M <sup>2</sup>	7,19
---	--------------------	----	-----	---------------------	------

## Uponor Comfort Pipe PLUS Rohr

 1062883	14x2,0 120m	1320	120	m M <sub>0</sub>	3,39
1062884	14x2,0 240m	1680	240	m M <sub>0</sub>	3,39
1062885	14x2,0 960m	1920	960	m M <sub>0</sub>	3,39
1009229	20x2,0 60m	660	60	m M <sub>0</sub>	3,62

## Uponor Comfort Pipe Rohr Minitec

 1063287	9,9x1,1 60m	840	60	m M <sup>2</sup>	4,11
1063288	9,9x1,1 120m	1680	120	m M <sup>2</sup>	4,11
1063381	9,9x1,1 480m	2880	480	m M <sup>2</sup>	4,11

## Uponor Magna pipe PLUS

 1091275	20x2,0 240m	960	240	m B <sub>7</sub>	3,65
1091276	20x2,0 480m	960	480	m B <sub>7</sub>	3,65

# Uponor Fix

Art-Nr.	Dimension	LE	VE	ME RG	Preis/ME
---------	-----------	----	----	----------	----------

## Uponor Vario Klemmringverschraubung PEX

 <b>1065283</b>	14x2,0-G $\frac{3}{4}$ "FT Euro	25	1	St. MZ	<b>7,88</b>
<b>1065290</b>	20x1,9/2,0-G $\frac{3}{4}$ "FT Euro	25	1	St. MZ	<b>8,23</b>

## Uponor Smart Presskupplung

 <b>1089646</b>	14x2,0-14x2,0	80	20	St. MZ	<b>11,75</b>
--	---------------	----	----	-----------	--------------

## Uponor Fit Übergangverschraubung PEX

 <b>1065294</b>	14x2,0-R $\frac{1}{2}$ "MT	25	1	St. MZ	<b>19,77</b>
--	----------------------------	----	---	-----------	--------------

## Uponor Fit Übergangverschraubung PEX

 <b>1065295</b>	14x2,0-Rp $\frac{1}{2}$ "FT	25	1	St. MZ	<b>20,60</b>
--	-----------------------------	----	---	-----------	--------------

## Uponor Q&E Kupplung m. Ringen DR

 <b>1058659</b>	14-14	100	10	St. MZ	<b>7,91</b>
--	-------	-----	----	-----------	-------------

## Uponor Q&E Ring natural, eval

 <b>1058428</b>	14	900	20	St. MZ	<b>0,46</b>
---	----	-----	----	-----------	-------------

## Uponor Q&E Sicherungsring

 <b>1057454</b>	20	520	20	St. F1	<b>0,66</b>
--	----	-----	----	-----------	-------------

## Uponor MLCP RED Rohr

 <b>1096010</b>	14x1,6 240m	3120	240	m M1	<b>2,02</b>
<b>1096011</b>	14x1,6 480m	3360	480	m M1	<b>2,02</b>

## Uponor Vario Eurokonusverschraubung MLCP RED

 <b>1000117</b>	14x1,6- $\frac{3}{4}$ "Euro	80	20	St. MZ	<b>6,80</b>
--	-----------------------------	----	----	-----------	-------------

## Uponor MLCP RED Press-Kupplung

 <b>1048272</b>	14x1,6-14x1,6	80	20	St. MZ	<b>12,58</b>
--	---------------	----	----	-----------	--------------

## Uponor Multi PE Randdämmstreifen mit Klebefolie HB

 <b>NEU</b> <b>1135494</b>	150x8mm	-	250	m MZ	<b>1,51</b>
---	---------	---	-----	---------	-------------

## Uponor Minitec Ring

 <b>1005263</b>	9,9x1,1	1600	10	St. M $\frac{1}{2}$	<b>0,74</b>
--	---------	------	----	------------------------	-------------

## Uponor Minitec Eurokonusverschraubung

 <b>1005266</b>	9,9x1,1-G $\frac{3}{4}$ "Euro	100	10	St. M $\frac{1}{2}$	<b>12,91</b>
--	-------------------------------	-----	----	------------------------	--------------

Art-Nr.	Dimension	LE	VE	ME RG	Preis/ME
---------	-----------	----	----	----------	----------

## Uponor Minitec Kupplung

 <b>1005264</b>	9,9x1,1	100	10	St. M $\frac{1}{2}$	<b>11,19</b>
--	---------	-----	----	------------------------	--------------

## Uponor Q&E T-Stück reduziert Minitec

 <b>1020524</b>	20xMinitec9,9xQ&E20	75	5	St. MZ	<b>16,18</b>
--	---------------------	----	---	-----------	--------------

## Uponor Minitec Übergangsnippel

 <b>1005265</b>	9,9-R $\frac{1}{2}$ "MT	100	10	St. M $\frac{1}{2}$	<b>13,73</b>
--	-------------------------	-----	----	------------------------	--------------

## Uponor Q&E Kupplung red. Minitec

 <b>1020518</b>	20xMinitec9,9	150	5	St. MZ	<b>18,14</b>
--	---------------	-----	---	-----------	--------------

## Uponor Minitec Aufweitwerkzeug

 <b>1006247</b>	9,9x1,1	11	1	Set NET	<b>390,93</b>
--	---------	----	---	------------	---------------

## Uponor Q&E Aufweitwerkzeug mit Aufweitk. M12

 <b>OUT</b> <b>1063112</b>	6BAR 9,9/20	-	1	Set NET	<b>661,08</b>
---	-------------	---	---	------------	---------------

Lieferung solange Vorrat reicht. Artikel läuft im Laufe des Jahres aus.

## Uponor Q&E Aufweitwerkzeug mit Aufweitk. M12/

 <b>1119375</b>	6bar 9,9RS/20	-	1	Set NET	<b>687,02</b>
--	---------------	---	---	------------	---------------

## Uponor Multi Rohrführungsbogen

 <b>NEU</b> <b>1135490</b>	10-12	360	60	St. D1	<b>1,48</b>
<b>NEU</b> <b>1135491</b>	14-18	240	30	St. D1	<b>3,79</b>
<b>NEU</b> <b>1135492</b>	20-22	140	35	St. D1	<b>4,67</b>

# Uponor Classic

Art-Nr.	Dimension	LE	VE	ME RG	Preis/ME
---------	-----------	----	----	----------	----------

## Uponor Classic Stahlmatte beschichtet

 <b>1005085</b>	50mm 2150x750x3mm	450	15	m <sup>2</sup> M5	<b>28,35</b>
<b>1005084</b>	100mm 2100x1200x3mm	750	25	m <sup>2</sup> M5	<b>12,91</b>
<b>1005087</b>	150mm 2100x1200x3mm	750	25	m <sup>2</sup> M5	<b>10,73</b>

## Uponor Classic Stahlmatte

 <b>1063406</b>	100mm 2100x1200x3mm	750	25	m <sup>2</sup> M5	<b>10,22</b>
<b>1063407</b>	150mm 2100x1200x3mm	750	25	m <sup>2</sup> M5	<b>7,29</b>

## Uponor Classic Mattenbinder

 <b>1007393</b>	80mm (100pce/set)	2500	50	Set M5	<b>5,39</b>
--	-------------------	------	----	-----------	-------------

## Uponor Classic Rohhalter für Stahlmatte

 <b>1005188</b>	16mm 3mm	500	500	St. M5	<b>0,43</b>
<b>1005189</b>	17mm 3mm	5000	500	St. M5	<b>0,43</b>
<b>1005190</b>	20mm 3mm	2800	280	St. M5	<b>0,63</b>

Hinweis: Verkauf pro Verpackungseinheit.

## Uponor Multi Randdämmstreifen mit Folie

 <b>1000079</b>	150x8mm	-	200	m MZ	<b>1,51</b>
--	---------	---	-----	---------	-------------

Hinweis: Verkauf pro Verpackungseinheit.

## Uponor Multi Randdämmstreifen mit Klebefolie

 <b>1000080</b>	150x10mm	-	200	m MZ	<b>3,08</b>
--	----------	---	-----	---------	-------------

Hinweis: Verkauf pro Verpackungseinheit.

## Uponor Multi PE Randdämmstreifen mit Klebefolie HB

 <b>NEU</b> <b>1135494</b>	150x8mm	-	250	m MZ	<b>1,51</b>
---	---------	---	-----	---------	-------------

## Uponor Multi Dehnungsfugenprofil

 <b>1090229</b>	1800x100x10mm	720	18	m MZ	<b>14,14</b>
--	---------------	-----	----	---------	--------------

## Uponor Multi Schutzhülse

 <b>1000082</b>	20mm 300x5mm	1800	30	St. MZ	<b>1,37</b>
--	--------------	------	----	-----------	-------------

## Uponor Comfort Pipe PLUS Blue Rohr

 <b>1126541</b>	16x2,0 640m	640	640	m M0	<b>4,24</b>
<b>1126542</b>	20x2,0 480m	480	480	m M0	<b>5,11</b>

## Uponor Comfort Pipe PLUS Rohr

 <b>1034535</b>	17x2,0 120m	840	120	m M0	<b>3,56</b>
<b>1009226</b>	17x2,0 240m	1200	240	m M0	<b>3,56</b>
<b>1086340</b>	17x2,0 480m	960	480	m M0	<b>3,56</b>
<b>1009227</b>	17x2,0 640m	1280	640	m M0	<b>3,56</b>

## Uponor Magna pipe PLUS

 <b>1091275</b>	20x2,0 240m	960	240	m B7	<b>3,65</b>
<b>1091276</b>	20x2,0 480m	960	480	m B7	<b>3,65</b>

Art-Nr.	Dimension	LE	VE	ME RG	Preis/ME
---------	-----------	----	----	----------	----------

## Uponor Vario Klemmringverschraubung PEX

 <b>1065284</b>	16x1,8/2,0-G¾"FT Euro	25	1	St. MZ	<b>7,88</b>
<b>1065286</b>	17x2,0-G¾"FT Euro	25	1	St. MZ	<b>7,88</b>
<b>1065290</b>	20x1,9/2,0-G¾"FT Euro	25	1	St. MZ	<b>8,23</b>

## Uponor Fit Schraubkupplung PEX

 <b>1065296</b>	16x1,8/2,0-16x1,8/2,0	25	1	St. MZ	<b>25,59</b>
<b>1065299</b>	17x2,0-17x2,0	25	1	St. MZ	<b>24,32</b>
<b>1065302</b>	20x1,9/2,0-20x1,9/2,0	25	1	St. MZ	<b>39,39</b>

## Uponor Smart Presskupplung

 <b>1089648</b>	20x2,0-20x2,0	80	20	St. MZ	<b>14,84</b>
--	---------------	----	----	-----------	--------------

## Uponor Fit Übergangverschraubung PEX

 <b>1065297</b>	16x1,8/2,0-R½"MT	25	1	St. MZ	<b>20,83</b>
<b>1065300</b>	17x2,0-R½"MT	25	1	St. MZ	<b>17,09</b>
<b>1065305</b>	20x1,9/2,0-R¾"MT	25	1	St. MZ	<b>25,89</b>

## Uponor Fit Übergangverschraubung PEX

 <b>1065298</b>	16x1,8/2,0-Rp½"FT	25	1	St. MZ	<b>19,84</b>
<b>1065306</b>	20x1,9/2,0-Rp¾"FT	25	1	St. MZ	<b>26,80</b>

## Uponor Rapex Press-Kupplung

 <b>1005079</b>	17-17	100	10	St. MZ	<b>15,61</b>
--	-------	-----	----	-----------	--------------

## Uponor Q&E Kupplung m. Ringen DR

 <b>1058660</b>	16x1,8/2,0-16x1,8/2,0	100	10	St. MZ	<b>9,57</b>
<b>1058661</b>	17-17	100	10	St. MZ	<b>11,33</b>
<b>1058668</b>	20-20	80	10	St. MZ	<b>11,33</b>

## Uponor Multi Rohrführungsbogen

 <b>1135491</b>	14-18	240	30	St. D1	<b>3,79</b>
<b>1135492</b>	20-22	140	35	St. D1	<b>4,67</b>

## Uponor Classic Clipmaster

 <b>1006295</b>	16/17mm l=920mm	100	1	St. NET	<b>248,59</b>
<b>1006309</b>	20mm l=920mm	-	1	St. NET	<b>378,88</b>

## Uponor Classic Drillgerät f.Mattenbinder

 <b>1006243</b>	l=320mm	50	1	St. NET	<b>26,19</b>
--	---------	----	---	------------	--------------

# Uponor Siccus 14

Art-Nr.	Dimension	LE	VE	ME RG	Preis/ME
---------	-----------	----	----	----------	----------

## Uponor Siccus 14 Verlegeplatte

 <b>1005485</b>	EPS 150kPa 14mm 1197x1050x25mm	100	12,5	$\frac{m^2}{M^3}$	<b>20,91</b>
--	-----------------------------------	-----	------	-------------------	--------------

## Uponor Siccus 14 Wärmeleitlamelle

 <b>1005486</b>	14mm 1180x120x0,45mm	768	48	$\frac{St.}{M^3}$	<b>8,16</b>
--	----------------------	-----	----	-------------------	-------------

## Uponor Comfort Pipe PLUS Rohr

 <b>1062883</b>	14x2,0 120m	1320	120	$\frac{m}{MO}$	<b>3,39</b>
<b>1062884</b>	14x2,0 240m	1680	240	$\frac{m}{MO}$	<b>3,39</b>
<b>1088166</b>	14x2,0 640m	1920	640	$\frac{m}{MO}$	<b>3,39</b>
<b>1062885</b>	14x2,0 960m	1920	960	$\frac{m}{MO}$	<b>3,39</b>

## Uponor Vario Klemmringverschraubung PEX

 <b>1065283</b>	14x2,0-G $\frac{3}{4}$ "FT Euro	25	1	$\frac{St.}{MZ}$	<b>7,88</b>
--	---------------------------------	----	---	------------------	-------------

## Uponor Fit Übergangverschraubung PEX

 <b>1065294</b>	14x2,0-R $\frac{1}{2}$ "MT	25	1	$\frac{St.}{MZ}$	<b>19,77</b>
--	----------------------------	----	---	------------------	--------------

## Uponor Fit Übergangverschraubung PEX

 <b>1065295</b>	14x2,0-Rp $\frac{1}{2}$ "FT	25	1	$\frac{St.}{MZ}$	<b>20,60</b>
--	-----------------------------	----	---	------------------	--------------

## Uponor Q&E Kupplung m. Ringen DR

 <b>1058659</b>	14-14	100	10	$\frac{St.}{MZ}$	<b>7,91</b>
--	-------	-----	----	------------------	-------------

## Uponor Q&E Ring natural, eval

 <b>1058428</b>	14	900	20	$\frac{St.}{MZ}$	<b>0,46</b>
--	----	-----	----	------------------	-------------

## Uponor Smart Presskupplung

 <b>1089646</b>	14x2,0-14x2,0	80	20	$\frac{St.}{MZ}$	<b>11,75</b>
--	---------------	----	----	------------------	--------------

Art-Nr.	Dimension	LE	VE	ME RG	Preis/ME
---------	-----------	----	----	----------	----------

## Uponor MLCP RED Rohr

 <b>1096010</b>	14x1,6 240m	3120	240	$\frac{m}{M1}$	<b>2,02</b>
<b>1096011</b>	14x1,6 480m	3360	480	$\frac{m}{M1}$	<b>2,02</b>

## Uponor Vario Eurokonusverschraubung MLCP RED

 <b>1000117</b>	14x1,6- $\frac{3}{4}$ "Euro	80	20	$\frac{St.}{MZ}$	<b>6,80</b>
--	-----------------------------	----	----	------------------	-------------

## Uponor MLCP RED Press-Kupplung

 <b>1048272</b>	14x1,6-14x1,6	80	20	$\frac{St.}{MZ}$	<b>12,58</b>
--	---------------	----	----	------------------	--------------

## Uponor Multi Randdämmstreifen mit Folie

 <b>1000079</b>	150x8mm	-	200	$\frac{m}{MZ}$	<b>1,51</b>
--	---------	---	-----	----------------	-------------

*Hinweis: Verkauf pro Verpackungseinheit.*

## Uponor Multi PE Randdämmstreifen mit Klebefolie HB

 <b>NEU 1135494</b>	150x8mm	-	250	$\frac{m}{MZ}$	<b>1,51</b>
--	---------	---	-----	----------------	-------------

## Uponor Multi Rohrführungsbogen

 <b>1135491</b>	14-18	240	30	$\frac{St.}{D1}$	<b>3,79</b>
--	-------	-----	----	------------------	-------------

## Uponor Siccus Sport Stahlblechabdeckung

 <b>1085611</b>	26sqm 0,6X1000X2000mm	-	26	$\frac{m^2}{M^3}$	<b>62,86</b>
<b>1085610</b>	204sqm 0,6x1000x2000mm	-	204	$\frac{m^2}{M^3}$	<b>49,02</b>

## Uponor Siccus 14 Schneidegerät

 <b>1006290</b>	14mm 230V	20	1	$\frac{St.}{NET}$	<b>272,85</b>
--	-----------	----	---	-------------------	---------------

## Uponor Siccus 14 Schneideinsatz

 <b>1006291</b>	14	-	1	$\frac{St.}{U1}$	<b>265,57</b>
--	----	---	---	------------------	---------------

Installation

Flächenheizung  
und -kühlungNahwärme-  
versorgung

Werkzeuge

Anhang



# Uponor Renovis

Art-Nr.	Dimension	LE	VE	ME RG	Preis/ME
<b>Uponor Renovis Panel</b>					
 1061173	800x625mm	-	24	St. MR	115,96
1061172	1200x625mm	-	24	St. MR	156,66
1061171	2000x625mm	-	24	St. MR	176,07

## Uponor Renovis Panel extra

 1063923	800x625x15mm	24	1	St. MR	129,23
1063924	1200x625x15mm	24	1	St. MR	162,66
1063925	2000x625x15mm	24	1	St. MR	195,49

## Uponor Renovis Panel

 1063926	2000x625x15mm	-	24	St. MR	44,78
---	---------------	---	----	-----------	-------

## Uponor Renovis Anschlusset

 1061165	4-6X	10	1	Set MR	628,24
---	------	----	---	-----------	--------

## Uponor Fix Klemmschiene

 1005274	9,9mm c/c20mm 2,5m	25	2,5	m M²	7,19
--	--------------------	----	-----	---------	------

## Uponor Renovis Klemmschiene

 1061162	20mm l=250mm	-	15	St. MR	6,38
---	--------------	---	----	-----------	------

## Uponor Comfort Pipe Rohr Minitec

 1063287	9,9x1,1 60m	840	60	m M²	4,11
1063288	9,9x1,1 120m	1680	120	m M²	4,11

## Uponor Minitec Übergangsnippel

 1005265	9,9-R½"MT	100	10	St. M²	13,73
---	-----------	-----	----	-----------	-------

## Uponor Minitec Kupplung

 1005264	9,9x1,1	100	10	St. M²	11,19
---	---------	-----	----	-----------	-------

## Uponor Minitec Ring

 1005263	9,9x1,1	1600	10	St. M²	0,74
---	---------	------	----	-----------	------

## Uponor Comfort Pipe PLUS Rohr

 1009229	20x2,0 60m	660	60	m M0	3,62
---	------------	-----	----	---------	------

## Uponor Magna pipe PLUS

 1091275	20x2,0 240m	960	240	m B7	3,65
1091276	20x2,0 480m	960	480	m B7	3,65

Art-Nr.	Dimension	LE	VE	ME RG	Preis/ME
---------	-----------	----	----	----------	----------

## Uponor Q&E T-Stück reduziert Minitec

 1020524	20xMinitec9,9xQ&E20	75	5	St. MZ	16,18
---	---------------------	----	---	-----------	-------

## Uponor Q&E Kupplung red. Minitec

 1020518	20xMinitec9,9	150	5	St. MZ	18,14
---	---------------	-----	---	-----------	-------

## Uponor Q&E Kupplung PPSU

 1008932	20-20	80	5	St. F1	6,03
---	-------	----	---	-----------	------

## Uponor Q&E Kupplung m. Ringen CE PPSU

 1072005	20-20	30	1	St. F1	7,07
---	-------	----	---	-----------	------

## Uponor Q&E Winkel PPSU

 1008680	20-20	40	5	St. F1	8,03
---	-------	----	---	-----------	------

## Uponor Q&E Sicherungsring

 1057454	20	520	20	St. F1	0,66
---	----	-----	----	-----------	------

## Uponor Uni Pipe PLUS weiß S

 1060784	20x2,25 3m	51	3	m E1	10,52
---	------------	----	---	---------	-------

## Uponor Q&E T-Stück Übergang S-Press

 1063938	20-Q&E9,9-Press20	6	2	St. D1	16,34
---	-------------------	---	---	-----------	-------

## Uponor Q&E Übergang S-Press

 1063939	20-Q&E9,9	12	2	St. D1	13,07
---	-----------	----	---	-----------	-------

## Uponor Vario VL-Feinregulierventil

 1005107	½" - G¾	50	1	St. MZ	40,00
---	---------	----	---	-----------	-------

## Uponor Vario RL-Ventil

 1005108	½" - G¾	50	1	St. MZ	34,11
---	---------	----	---	-----------	-------



# Uponor Renovis

Art-Nr.	Dimension	LE	VE	ME RG	Preis/ME
---------	-----------	----	----	----------	----------

## Uponor Vario PLUS Thermoantrieb NC

 <b>1005605</b>	230V MT30x1,5	10	1	St. MZ	<b>82,29</b>
--	---------------	----	---	-----------	--------------

## Uponor Base Raumfühler T-23

 <b>1058422</b>	230V RAL9010	160	1	St. MZ	<b>57,25</b>
--	--------------	-----	---	-----------	--------------

## Uponor Minitec Aufweitwerkzeug

 <b>1006247</b>	9,9x1,1	11	1	Set NET	<b>390,93</b>
--	---------	----	---	------------	---------------

Art-Nr.	Dimension	LE	VE	ME RG	Preis/ME
---------	-----------	----	----	----------	----------

## Uponor Q&E Aufweitwerkzeug mit Aufweitk. M12

 <b>OUT</b> <b>1063112</b>	6BAR 9,9/20	-	1	Set NET	<b>661,08</b>
---	-------------	---	---	------------	---------------

Lieferung solange Vorrat reicht. Artikel läuft im Laufe des Jahres aus.

## Uponor Q&E Aufweitwerkzeug mit Aufweitk. M12/

 <b>1119375</b>	6bar 9,9RS/20	-	1	Set NET	<b>687,02</b>
--	---------------	---	---	------------	---------------

## Uponor Multi Rohrführungsbogen

 <b>NEU</b> <b>1135490</b>	10-12	360	60	St. D1	<b>1,48</b>
<b>NEU</b> <b>1135491</b>	14-18	240	30	St. D1	<b>3,79</b>

# Uponor Comfort E

## Uponor Comfort E Kabelmatte set T-87IF

 <b>1088668</b>	160-1	50	1	Set MC	<b>388,89</b>
<b>1088669</b>	160-1,5	50	1	Set MC	<b>454,62</b>
<b>1088670</b>	160-2	50	1	Set MC	<b>478,04</b>
<b>1088671</b>	160-2,5	50	1	Set MC	<b>543,81</b>
<b>1088672</b>	160-3	50	1	Set MC	<b>559,88</b>
<b>1088673</b>	160-4	35	1	Set MC	<b>631,56</b>
<b>1088674</b>	160-5	35	1	Set MC	<b>697,32</b>
<b>1088675</b>	160-6	35	1	Set MC	<b>774,61</b>
<b>1088676</b>	160-7	20	1	Set MC	<b>840,37</b>
<b>1088677</b>	160-8	20	1	Set MC	<b>884,41</b>
<b>1088678</b>	160-10	20	1	Set MC	<b>957,49</b>
<b>1088679</b>	160-12	20	1	Set MC	<b>1103,68</b>

## Uponor Comfort E Kabelmatte

 <b>1088656</b>	160-1	50	1	Set MC	<b>157,88</b>
<b>1088657</b>	160-1,5	50	1	Set MC	<b>213,41</b>
<b>1088658</b>	160-2	50	1	Set MC	<b>244,15</b>
<b>1088659</b>	160-2,5	50	1	Set MC	<b>323,10</b>
<b>1088660</b>	160-3	50	1	Set MC	<b>339,16</b>
<b>1088661</b>	160-4	35	1	Set MC	<b>441,50</b>
<b>1088662</b>	160-5	35	1	Set MC	<b>519,82</b>
<b>1088663</b>	160-6	35	1	Set MC	<b>615,44</b>
<b>1088664</b>	160-7	20	1	Set MC	<b>708,83</b>
<b>1088665</b>	160-8	20	1	Set MC	<b>787,59</b>
<b>1088666</b>	160-10	20	1	Set MC	<b>866,36</b>
<b>1088667</b>	160-12	20	1	Set MC	<b>1030,41</b>

## Uponor Comfort E Analoges Thermostat set T-85

 <b>1088705</b>	230V	-	1	Set MC	<b>149,65</b>
--	------	---	---	-----------	---------------

## Uponor Comfort E UP-therm. dig. Progr. flush Set T-87IF

 <b>1088706</b>	230V	-	1	Set MC	<b>299,71</b>
--	------	---	---	-----------	---------------

## Uponor Comfort E Bodenfühler T-85, T-87

 <b>1090944</b>		100	1	St. MC	<b>33,10</b>
--	--	-----	---	-----------	--------------

# Uponor Siccus wall

Art-Nr.	Dimension	LE	VE	ME RG	Preis/ME
---------	-----------	----	----	----------	----------

## Uponor Siccus 14 Verlegeplatte

 <b>1005485</b>	EPS 150kPa 14mm 1197x1050x25mm	100	12,5	$\frac{m^2}{M^3}$	<b>20,91</b>
--	-----------------------------------	-----	------	-------------------	--------------

## Uponor Siccus 14 Wärmeleitlamelle

 <b>1005486</b>	14mm 1180x120x0,45mm	768	48	St. M <sup>3</sup>	<b>8,16</b>
--	----------------------	-----	----	-----------------------	-------------

## Uponor Comfort Pipe PLUS Rohr

 <b>1062883</b>	14x2,0 120m	1320	120	$\frac{m}{M0}$	<b>3,39</b>
<b>1062884</b>	14x2,0 240m	1680	240	$\frac{m}{M0}$	<b>3,39</b>
<b>1062885</b>	14x2,0 960m	1920	960	$\frac{m}{M0}$	<b>3,39</b>

## Uponor Vario Klemmringverschraubung PEX

 <b>1065283</b>	14x2,0-G $\frac{3}{4}$ "FT Euro	25	1	St. MZ	<b>7,88</b>
--	---------------------------------	----	---	-----------	-------------

## Uponor Fit Übergangverschraubung PEX

 <b>1065294</b>	14x2,0-R $\frac{1}{2}$ "MT	25	1	St. MZ	<b>19,77</b>
---	----------------------------	----	---	-----------	--------------

## Uponor Fit Übergangverschraubung PEX

 <b>1065295</b>	14x2,0-Rp $\frac{1}{2}$ "FT	25	1	St. MZ	<b>20,60</b>
--	-----------------------------	----	---	-----------	--------------

## Uponor Q&E Kupplung m. Ringen DR

 <b>1058659</b>	14-14	100	10	St. MZ	<b>7,91</b>
--	-------	-----	----	-----------	-------------

## Uponor Q&E Ring natural, eval

 <b>1058428</b>	14	900	20	St. MZ	<b>0,46</b>
--	----	-----	----	-----------	-------------

## Uponor Smart Presskupplung

 <b>1089646</b>	14x2,0-14x2,0	80	20	St. MZ	<b>11,75</b>
--	---------------	----	----	-----------	--------------

Art-Nr.	Dimension	LE	VE	ME RG	Preis/ME
---------	-----------	----	----	----------	----------

## Uponor MLCP RED Rohr

 <b>1096010</b>	14x1,6 240m	3120	240	$\frac{m}{M1}$	<b>2,02</b>
<b>1096011</b>	14x1,6 480m	3360	480	$\frac{m}{M1}$	<b>2,02</b>

## Uponor Vario Eurokonusverschraubung MLCP RED

 <b>1000117</b>	14x1,6- $\frac{3}{4}$ "Euro	80	20	St. MZ	<b>6,80</b>
--	-----------------------------	----	----	-----------	-------------

## Uponor MLCP RED Press-Kupplung

 <b>1048272</b>	14x1,6-14x1,6	80	20	St. MZ	<b>12,58</b>
--	---------------	----	----	-----------	--------------

## Uponor Siccus 14 Schneidegerät

 <b>1006290</b>	14mm 230V	20	1	St. NET	<b>272,85</b>
--	-----------	----	---	------------	---------------

# Uponor Thermatop Deckensystem

Art-Nr.	Dimension	LE	VE	ME RG	Preis/ME
---------	-----------	----	----	----------	----------

## Uponor Thermatop M



1090933	950x277mm	200	10	St. I6	71,06
1090934	1350x277mm	200	10	St. I6	99,88
1090935	1750x277mm	200	10	St. I6	128,70
1090936	2150x277mm	200	10	St. I6	161,20
1090937	2550x277mm	200	10	St. I6	189,59

### Verbindungstechnik: S-Press PLUS oder RTM

Verbindungstechnik: die einzelnen Module können mit der üblichen Uponor-Verbindungstechnologie S-Press oder RTM verbunden werden

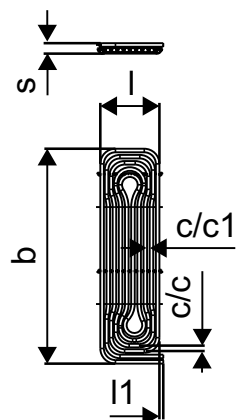

Art-Nr.	Dimension	LE	VE	ME RG	Preis/ME
---------	-----------	----	----	----------	----------

## Uponor Uni-X Verschraubung MLC



1058090	16-3/4"FT Euro	25	1	St. D1	9,20
---------	----------------	----	---	-----------	------

## Uponor S-Press PLUS Kupplung



1070547	16-16	80	20	St. D1	11,76
---------	-------	----	----	-----------	-------

## Uponor S-Press PLUS Kupplung PPSU



1039933	16-16	80	20	St. E1	7,39
---------	-------	----	----	-----------	------

Installation

Flächenheizung  
und -kühlung

Nahwärme-  
versorgung

Werkzeuge

Anhang

# Uponor Multi – Zubehör Fußbodenaufbau

Art-Nr.	Dimension	LE	VE	ME RG	Preis/ME
---------	-----------	----	----	----------	----------

## Uponor Multi Rohrbinder PA

 <b>1005372</b>	300mm	6000	100	St. B7	<b>0,35</b>
--	-------	------	-----	-----------	-------------

Hinweis: Verkauf pro Verpackungseinheit.

## Uponor Multi Rohrbinder PA

 <b>1086531</b>	200mm	10000	100	St. B7	<b>0,23</b>
--	-------	-------	-----	-----------	-------------

Hinweis: Verkauf pro Verpackungseinheit.

## Uponor Multi Klemmschiene

 <b>1005358</b>	20mm c/c50mm 3m	30	3	m B3	<b>10,00</b>
--	-----------------	----	---	---------	--------------

## Uponor Multi Dampfsperre PE

 <b>1005069</b>	3/300 3,3mm 40x1,25m	250	50	m <sup>2</sup> MZ	<b>11,93</b>
--	----------------------	-----	----	----------------------	--------------

Hinweis: Verkauf pro Verpackungseinheit von 1 Rolle = 50 m<sup>2</sup>

## Uponor Multi Dicht- und Klebeband PE 3/300

 <b>1005071</b>	15m	8	1	St. MZ	<b>77,52</b>
--	-----	---	---	-----------	--------------

## Uponor Multi Folie PE

 <b>1005051</b>	0,1mm 75x2m	6900	150	m <sup>2</sup> MZ	<b>1,38</b>
--	-------------	------	-----	----------------------	-------------

Hinweis: Verkauf pro Verpackungseinheit von 1 Rolle

## Uponor Multi Folie PE

 <b>1005049</b>	0,2mm 60x1,25m	3375	75	m <sup>2</sup> MZ	<b>2,11</b>
--	----------------	------	----	----------------------	-------------

Hinweis: Verkauf pro Verpackungseinheit.

## Uponor Multi Rasterfolie

 <b>OUT 1000015</b>	0,25mm 100x1,03m	2472	103	m <sup>2</sup> M8	<b>4,30</b>
--	------------------	------	-----	----------------------	-------------

Lieferung solange Vorrat reicht. Artikel läuft im Laufe des Jahres aus.

## Uponor Multi Foliendübel

 <b>1000016</b>	l=25mm	5000	100	St. MZ	<b>0,40</b>
--	--------	------	-----	-----------	-------------

Hinweis: Verkauf pro Verpackungseinheit.

## Uponor Multi Randdämmstreifen mit Klebefolie

 <b>1000080</b>	150x10mm	-	200	m MZ	<b>3,08</b>
--	----------	---	-----	---------	-------------

Hinweis: Verkauf pro Verpackungseinheit.

## Uponor Multi Randdämmstreifen mit Folie

 <b>1000079</b>	150x8mm	-	200	m MZ	<b>1,51</b>
--	---------	---	-----	---------	-------------

Hinweis: Verkauf pro Verpackungseinheit.

Art-Nr.	Dimension	LE	VE	ME RG	Preis/ME
---------	-----------	----	----	----------	----------

## Uponor Multi PE Randdämmstreifen mit Klebefolie HB

 <b>NEU 1135494</b>	150x8mm	-	250	m MZ	<b>1,51</b>
--	---------	---	-----	---------	-------------

## Uponor Multi Dehnungsfugenprofil

 <b>1090229</b>	1800x100x10mm	720	18	m MZ	<b>14,14</b>
--	---------------	-----	----	---------	--------------

## Uponor Multi Klebeband

 <b>1000012</b>	66m 50mm	36	1	St. MZ	<b>8,25</b>
--	----------	----	---	-----------	-------------

## Uponor Multi Schutzhülse

 <b>1000082</b>	20mm 300x5mm	1800	30	St. MZ	<b>1,37</b>
--	--------------	------	----	-----------	-------------

## Uponor Multi Estrichkomponente VD 450

 <b>1000084</b>	20L	480	20	l MZ	<b>6,88</b>
--	-----	-----	----	---------	-------------

Hinweis: Vor Frost und UV - Strahlung schützen. Rücknahme ausgeschlossen.

## Uponor Multi Estrichkomponente VD 550 N

 <b>1000085</b>	25L	600	25	l MZ	<b>13,50</b>
--	-----	-----	----	---------	--------------

Hinweis: Vor Frost und UV - Strahlung schützen. Rücknahme ausgeschlossen.

## Uponor Multi Messstellenmarkierung

 <b>1000083</b>	100mm	-	10	St. MZ	<b>7,88</b>
--	-------	---	----	-----------	-------------

## Uponor Multi Gebundene Schüttung

 <b>1000052</b>	100l	2500	100	l C1	<b>1,58</b>
--	------	------	-----	---------	-------------

Hinweis: Verkauf pro Verpackungseinheit von 1 Sack = 100 l

## Uponor Multi Frostschutzmittel

 <b>1005066</b>	≥ -30 °C 20 l	480	20	l MZ	<b>22,80</b>
--	---------------	-----	----	---------	--------------

# Verteil und Steigleitungen > 20 mm

Art-Nr.	Dimension	LE	VE	ME RG	Preis/ME
 <b>1060785</b>	25x2,5 3m	30	3	m E1	<b>15,36</b>
<b>1060786</b>	32x3,0 3m	21	3	m E1	<b>21,98</b>

## Uponor MLC Rohr weiß S

 <b>1013448</b>	40x4,0 3m	12	3	m E1	<b>40,93</b>
<b>1021980</b>	50x4,5 3m	12	3	m E1	<b>58,04</b>
<b>1021981</b>	63x6,0 3m	9	3	m E1	<b>73,61</b>
<b>1013453</b>	75x7,5 5m	255	5	m E1	<b>116,29</b>

## Uponor S-Press PLUS Kupplung PPSU

 <b>1039935</b>	25-25	80	10	St. E1	<b>14,98</b>
<b>1039936</b>	32-32	80	10	St. E1	<b>22,01</b>

## Uponor S-Press Verbund Kupplung PPSU

 <b>1046401</b>	40-40	960	5	St. E1	<b>42,54</b>
<b>1046402</b>	50-50	576	3	St. E1	<b>56,36</b>
<b>1032881</b>	63-63	384	1	St. E1	<b>105,69</b>
<b>1032882</b>	75-75	384	1	St. E1	<b>170,99</b>

## Uponor S-Press PLUS Kupplung reduziert PPSU

 <b>1039940</b>	32-25	80	10	St. E1	<b>22,52</b>
<b>1039941</b>	40-25	960	5	St. E1	<b>39,73</b>
<b>1039942</b>	40-32	960	5	St. E1	<b>39,73</b>
<b>1039943</b>	50-32	1152	3	St. E1	<b>51,77</b>

## Uponor S-Press Verbund Kupplung red. PPSU

 <b>1046406</b>	50-40	576	3	St. E1	<b>56,91</b>
<b>1032883</b>	63-40	384	1	St. E1	<b>98,14</b>
<b>1032884</b>	63-50	384	1	St. E1	<b>100,23</b>
<b>1032885</b>	75-50	384	1	St. E1	<b>144,22</b>
<b>1032886</b>	75-63	384	1	St. E1	<b>159,49</b>

## Uponor S-Press PLUS Winkel PPSU

 <b>1039931</b>	25-25	80	10	St. E1	<b>21,58</b>
<b>1039932</b>	32-32	20	5	St. E1	<b>29,71</b>

## Uponor S-Press Verbund Winkel PPSU

 <b>1046386</b>	40-40	960	5	St. E1	<b>60,82</b>
<b>1046387</b>	50-50	576	3	St. E1	<b>78,35</b>
<b>1032877</b>	63-63	210	1	St. E1	<b>144,98</b>
<b>1032878</b>	75-75	210	1	St. E1	<b>222,70</b>

## Uponor S-Press Verbund Winkel 45° PPSU

 <b>1046388</b>	40-40	960	5	St. E1	<b>60,78</b>
<b>1046389</b>	50-50	576	3	St. E1	<b>83,38</b>
<b>1032879</b>	63-63	192	1	St. E1	<b>152,95</b>
<b>1032880</b>	75-75	192	1	St. E1	<b>208,07</b>

Art-Nr.	Dimension	LE	VE	ME RG	Preis/ME
 <b>1039946</b>	25-25-25	20	5	St. E1	<b>24,53</b>
<b>1039947</b>	32-32-32	20	5	St. E1	<b>40,27</b>

## Uponor S-Press Verbund T-Stück PPSU

 <b>1046390</b>	40-40-40	720	5	St. E1	<b>87,65</b>
<b>1046391</b>	50-50-50	288	3	St. E1	<b>103,67</b>
<b>1032887</b>	63-63-63	150	1	St. E1	<b>184,41</b>
<b>1032888</b>	75-75-75	150	1	St. E1	<b>290,64</b>

## Uponor S-Press PLUS T-Stück m. Innengew.

 <b>1070598</b>	25-Rp1½"FT-25	20	5	St. E1	<b>46,12</b>
<b>1070600</b>	32-Rp1½"FT-32	20	5	St. E1	<b>66,08</b>

## Uponor S-Press T-Stück mit Innengewinde

 <b>1046922</b>	40-Rp1½"FT-40	500	5	St. E1	<b>76,88</b>
<b>1046929</b>	50-Rp1"FT-50	240	3	St. E1	<b>127,87</b>

## Uponor S-Press PLUS Übergangsnippel

 <b>1070507</b>	25-R¾"MT	80	10	St. E1	<b>23,80</b>
<b>1070508</b>	25-R1"MT	40	5	St. E1	<b>28,12</b>
<b>1070509</b>	32-R1"MT	40	5	St. E1	<b>30,96</b>
<b>1070510</b>	32-R1 ¼"MT	20	5	St. E1	<b>40,12</b>

## Uponor S-Press Übergangsnippel

 <b>1046901</b>	40-R1 ¼"MT	960	5	St. E1	<b>50,14</b>
<b>1046902</b>	40-R1 ½"MT	960	5	St. E1	<b>55,43</b>
<b>1046905</b>	50-R1 ½"MT	1152	3	St. E1	<b>83,17</b>
<b>1046906</b>	50-R2"MT	576	3	St. E1	<b>106,88</b>
<b>1032895</b>	63-R2"MT	336	1	St. E1	<b>151,75</b>
<b>1032896</b>	75-R2 ½"MT	336	1	St. E1	<b>200,05</b>

## Uponor S-Press PLUS Übergangsmuffe

 <b>1070519</b>	25-Rp¾"FT	40	5	St. E1	<b>27,68</b>
<b>1070520</b>	25-Rp1"FT	40	5	St. E1	<b>29,14</b>
<b>1070521</b>	32-Rp1"FT	40	5	St. E1	<b>33,88</b>
<b>1070522</b>	32-Rp1 ¼"FT	20	5	St. E1	<b>41,80</b>

## Uponor S-Press Übergangsmuffe

 <b>1046903</b>	40-Rp1 ¼"FT	960	5	St. E1	<b>52,16</b>
<b>1046904</b>	40-Rp1 ½"FT	960	5	St. E1	<b>52,71</b>
<b>1046907</b>	50-Rp1 ½"FT	1152	3	St. E1	<b>127,09</b>

















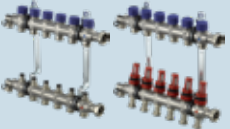
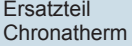

Installation

Flächenheizung  
und -kühlungNahwärme-  
versorgung

Werkzeuge

Anhang

# Übersicht Uponor Stellantriebe DE

Stellantrieb		Passend für Verteiler			
<b>Uponor Vario PLUS</b> Thermoantrieb PRO MT 30x1,5 		Uponor Vario PLUS 	Uponor Magna Industrieheizungs- verteiler 	Uponor Vario Regulierventil 	Uponor Vario RL-Ventil 
Typ	Art.-Nr.	Preis/ME			
24 V	1000138	82,29			
230 V	1005605	82,29			
<b>Uponor Vario Thermoantrieb S</b> FT 30x1,5 		Vario S Edelstahlverteiler ST, FM und LS 	Vario S Edelstahlverteiler ST, LS und FM (bis 2018) 	Ersatzteil Chronatherm 	
Typ	Art.-Nr.	Preis/ME			
24 V	1013008	43,83			
230 V	1013006	43,83			
<b>Uponor Vario S Thermoantrieb 1 W NC</b> FT 30x1,5 		Vario M mit Durchflussmesser FM 	Comfort Port vormontierte Verteilerstationen 		
Typ	Art.-Nr.	Preis/ME			
24 V	1087778	61,72			
230 V	1087763	45,43			
<b>Uponor Vario B Thermoantrieb PRO</b> FT 28x1,5 		Ersatzteil Uponor Fluvia T 	Ersatzteil Unipipe 		
Typ	Art.-Nr.	Preis/ME			
24 V	1007249	82,29			
230 V	1022244	82,29			
<b>Uponor Vario PLUS Adapter VA 02</b> 30 x 1,5 AG 		Ersatzteil Velta Kompakt und Velta Euro-Verteiler 			
Typ	Art.-Nr.	Preis/ME			
24 V	1090262	85,81			
230 V	1090263	85,81			
<b>Uponor Vario B Adapter VA 32</b> 28 x 1,5 IG 		Ersatzteil Polytherm ohne DF 	Ersatzteil Polytherm DF 		
Typ	Art.-Nr.	Preis/ME			
24 V	1090264	85,81			
230 V	1090265	85,81			



# Uponor Vario PLUS

Art-Nr.	Dimension	LE	VE	ME RG	Preis/ME
---------	-----------	----	----	----------	----------

## Uponor Vario PLUS Verteiler mit Ventil

 <b>1042420</b>	LS 1X ¾ Euro	10	1	Paar MZ	<b>77,37</b>
<b>1030580</b>	LS 3X ¾ Euro	290	1	Paar MZ	<b>188,44</b>
<b>1030581</b>	LS 4X ¾ Euro	225	1	Paar MZ	<b>236,33</b>
<b>1030582</b>	LS 6X ¾ Euro	155	1	Paar MZ	<b>334,81</b>

## Uponor Vario PLUS Verteiler m. Durchflm.

 <b>1042471</b>	FM 1X ¾ Euro	10	1	Paar MZ	<b>95,53</b>
<b>1030583</b>	FM 3X ¾ Euro	174	1	Paar MZ	<b>218,01</b>
<b>1030584</b>	FM 4X ¾ Euro	135	1	Paar MZ	<b>284,15</b>
<b>1030585</b>	FM 6X ¾ Euro	93	1	Paar MZ	<b>412,14</b>

## Uponor Vario PLUS Verteiler Basis Set

 <b>1009209</b>	K1	248	1	St. MZ	<b>149,07</b>
--	----	-----	---	-----------	---------------

## Uponor Vario PLUS Thermoantrieb NC

 <b>1000138</b>	24V MT30x1,5	10	1	St. MZ	<b>82,29</b>
<b>1005605</b>	230V MT30x1,5	10	1	St. MZ	<b>82,29</b>

## Uponor Vario Differenzdruckregler Compact

 <b>NEU</b> <b>1137437</b>	G1 - G1	125	1	Set MZ	<b>497,26</b>
---	---------	-----	---	-----------	---------------

## Uponor Vario Regulierventil G1-Rp1

 <b>NEU</b> <b>1137413</b>		10	1	Set MZ	<b>139,45</b>
---	--	----	---	-----------	---------------

## Uponor Vario PLUS Stellantrieb 100kOhm

 <b>1005544</b>	24V NC MT30x1,5 0-10V DC	100	1	St. MZ	<b>212,37</b>
--	--------------------------	-----	---	-----------	---------------

## Uponor Vario Klemmringverschraubung PEX

 <b>1065283</b>	14x2,0-G¾"FT Euro	25	1	St. MZ	<b>7,88</b>
<b>1065284</b>	16x1,8/2,0-G¾"FT Euro	25	1	St. MZ	<b>7,88</b>
<b>1065286</b>	17x2,0-G¾"FT Euro	25	1	St. MZ	<b>7,88</b>
<b>1065290</b>	20x1,9/2,0-G¾"FT Euro	25	1	St. MZ	<b>8,23</b>

## Uponor Vario PLUS Winkelset

 <b>1032702</b>	122/42	5	1	Paar MZ	<b>35,88</b>
--	--------	---	---	------------	--------------

## Uponor Vario PLUS Verteileranschlussset

 <b>1005227</b>		10	1	Set U1	<b>82,67</b>
--	--	----	---	-----------	--------------

## Uponor Vario PLUS Schlauchtülle

 <b>1009214</b>	G¾ x ½	10	1	St. MZ	<b>3,57</b>
--	--------	----	---	-----------	-------------

Art-Nr.	Dimension	LE	VE	ME RG	Preis/ME
---------	-----------	----	----	----------	----------

## Uponor Vario PLUS Distanzringset

 <b>1009215</b>		10	1	St. MZ	<b>13,08</b>
--	--	----	---	-----------	--------------

## Uponor Vario PLUS Dämmset

 <b>1063207</b>		-	1	Set MZ	<b>124,78</b>
--	--	---	---	-----------	---------------

## Uponor Vario Bezeichnungsschilder

 <b>1005063</b>	47x10mm	-	1	Set MZ	<b>38,81</b>
--	---------	---	---	-----------	--------------

## Uponor Vario PLUS Thermometer 0-60°C

 <b>1034524</b>	D=40mm	20	1	Paar U1	<b>27,52</b>
--	--------	----	---	------------	--------------

## Uponor Vario PLUS Durchflussmesser

 <b>1009217</b>	4 l/min	20	1	St. MZ	<b>20,60</b>
--	---------	----	---	-----------	--------------

## Uponor Vario PLUS Vorlauf-Ventileinsatz scale 1-5

 <b>1034523</b>		-	20	St. U1	<b>20,45</b>
---	--	---	----	-----------	--------------

## Uponor Vario PLUS Rücklaufventileinsatz

 <b>1005250</b>		10	1	St. U1	<b>18,06</b>
--	--	----	---	-----------	--------------

## Uponor Vario Rücklauf-Ventileinsatz

 <b>1005099</b>		10	1	St. U1	<b>39,69</b>
--	--	----	---	-----------	--------------

## Uponor Vario Vorlaufventil-Handrad, weiß

 <b>1005101</b>		-	1	St. U1	<b>3,25</b>
--	--	---	---	-----------	-------------

## Uponor Vario Handrad COMP

 <b>1005104</b>		100	10	St. U1	<b>4,49</b>
--	--	-----	----	-----------	-------------

## Uponor Vario Vorlaufventileinsatz

 <b>1005098</b>		-	1	St. U1	<b>39,06</b>
--	--	---	---	-----------	--------------















Installation

Flächenheizung  
und -kühlungNahwärme-  
versorgung

Werkzeuge

Anhang

# Uponor Vario M

Art-Nr.	Dimension	LE	VE	ME RG	Preis/ME
<b>Uponor Vario M Verteiler m. Durchflussm. FM</b>					
 <b>1085944</b>	2X G $\frac{3}{4}$ Euro	80	1	St. MZ	<b>229,25</b>
 <b>1085945</b>	3X G $\frac{3}{4}$ Euro	80	1	St. MZ	<b>295,42</b>
 <b>1085946</b>	4X G $\frac{3}{4}$ Euro	80	1	St. MZ	<b>362,93</b>
 <b>1085947</b>	5X G $\frac{3}{4}$ Euro	80	1	St. MZ	<b>430,42</b>
 <b>1085948</b>	6X G $\frac{3}{4}$ Euro	80	1	St. MZ	<b>489,51</b>
 <b>1085949</b>	7X G $\frac{3}{4}$ Euro	80	1	St. MZ	<b>554,23</b>
 <b>1085950</b>	8X G $\frac{3}{4}$ Euro	80	1	St. MZ	<b>621,72</b>
 <b>1085951</b>	9X G $\frac{3}{4}$ Euro	80	1	St. MZ	<b>686,47</b>
 <b>1085952</b>	10X G $\frac{3}{4}$ Euro	80	1	St. MZ	<b>759,40</b>
 <b>1086250</b>	11X G $\frac{3}{4}$ Euro	108	1	St. MZ	<b>843,79</b>
 <b>1086251</b>	12X G $\frac{3}{4}$ Euro	108	1	St. MZ	<b>907,35</b>
 <b>1087129</b>	13X G $\frac{3}{4}$ Euro	30	1	St. MZ	<b>1090,12</b>
 <b>1087130</b>	14X G $\frac{3}{4}$ Euro	30	1	St. MZ	<b>1146,27</b>
 <b>1087131</b>	15X G $\frac{3}{4}$ Euro	30	1	St. MZ	<b>1195,67</b>

## Uponor Vario Differenzdruckregler Compact

 <b>NEU</b> 1137437	G1 - G1	125	1	Set MZ	<b>497,26</b>
--	---------	-----	---	-----------	---------------

## Uponor Vario Regulierventil G1-Rp1

 <b>NEU</b> 1137413		10	1	Set MZ	<b>139,45</b>
--	--	----	---	-----------	---------------

## Uponor Vario M Verteiler Durchflussmesser

 <b>NEU</b> 1121531	0-5l/min	10	1	St. U1	<b>9,20</b>
--	----------	----	---	-----------	-------------

Art-Nr.	Dimension	LE	VE	ME RG	Preis/ME
---------	-----------	----	----	----------	----------

## Uponor Vario M Halterung

 <b>1087531</b>		-	1	Set U1	<b>27,32</b>
--	--	---	---	-----------	--------------

## Uponor Vario M Füll-/Entleerungsventil

 <b>1120810</b>		10	1	St. U1	<b>89,57</b>
--	--	----	---	-----------	--------------

## Uponor Vario Bezeichnungsschilder

 <b>1005063</b>	47x10mm	-	1	Set MZ	<b>38,81</b>
--	---------	---	---	-----------	--------------

## Uponor Vario M Rücklaufventil

 <b>1085957</b>		-	1	St. U1	<b>13,73</b>
--	--	---	---	-----------	--------------

## Uponor Vario M Thermometer

 <b>1085958</b>		-	1	Set U1	<b>18,72</b>
--	--	---	---	-----------	--------------

## Uponor Vario M Sicherheitsbügel Set

 <b>1085959</b>	3x2	-	1	Set U1	<b>9,44</b>
---	-----	---	---	-----------	-------------

## Uponor Vario B Stellantrieb NC

 <b>1007249</b>	24V FT28x1,5	10	1	St. MZ	<b>82,29</b>
<b>1022244</b>	230V FT28x1,5	10	1	St. MZ	<b>82,29</b>

## Uponor Vario S Thermoantrieb 230 V 1 W NC

 <b>1087763</b>	FT 30x1,5	100	1	St. MZ	<b>45,43</b>
--	-----------	-----	---	-----------	--------------

## Uponor Vario S Thermoantrieb 24 V 1 W NC

 <b>1087778</b>	FT 30x1,5	100	1	St. MZ	<b>61,72</b>
--	-----------	-----	---	-----------	--------------



# Uponor Vario S

Art-Nr.	Dimension	LE	VE	ME RG	Preis/ME
---------	-----------	----	----	----------	----------

## Uponor Vario S S-Verteiler FM

	<b>1086538</b> 2X $\frac{3}{4}$ Euro	108	1	St. MZ	<b>173,04</b>
	<b>1086539</b> 3x $\frac{3}{4}$ Euro	108	1	St. MZ	<b>223,65</b>
	<b>1086540</b> 4x $\frac{3}{4}$ Euro	108	1	St. MZ	<b>275,70</b>
	<b>1086541</b> 5x $\frac{3}{4}$ Euro	108	1	St. MZ	<b>324,93</b>
	<b>1086542</b> 6x $\frac{3}{4}$ Euro	72	1	St. MZ	<b>375,58</b>
	<b>1086543</b> 7X $\frac{3}{4}$ Euro	72	1	St. MZ	<b>424,80</b>
	<b>1086544</b> 8x $\frac{3}{4}$ Euro	72	1	St. MZ	<b>476,86</b>
	<b>1086545</b> 9x $\frac{3}{4}$ Euro	72	1	St. MZ	<b>528,92</b>
	<b>1086546</b> 10x $\frac{3}{4}$ Euro	48	1	St. MZ	<b>580,96</b>
	<b>1086547</b> 11x $\frac{3}{4}$ Euro	48	1	St. MZ	<b>633,01</b>
	<b>1086548</b> 12x $\frac{3}{4}$ Euro	48	1	St. MZ	<b>685,07</b>
	<b>1088864</b> 13x $\frac{3}{4}$ Euro	48	1	St. MZ	<b>752,57</b>
	<b>1088865</b> 14X $\frac{3}{4}$ Euro	36	1	St. MZ	<b>808,67</b>
	<b>1088866</b> 15x $\frac{3}{4}$ Euro	36	1	St. MZ	<b>865,07</b>
	<b>1088867</b> 16x $\frac{3}{4}$ Euro	36	1	St. MZ	<b>914,12</b>

## Uponor Vario S S Verteiler LS

	<b>1088045</b> 2X $\frac{3}{4}$ Euro	108	1	St. MZ	<b>161,74</b>
	<b>1088046</b> 3X $\frac{3}{4}$ Euro	108	1	St. MZ	<b>201,15</b>
	<b>1088047</b> 4X $\frac{3}{4}$ Euro	108	1	St. MZ	<b>230,71</b>
	<b>1088048</b> 5X $\frac{3}{4}$ Euro	108	1	St. MZ	<b>261,60</b>
	<b>1088049</b> 6X $\frac{3}{4}$ Euro	72	1	St. MZ	<b>298,22</b>
	<b>1088050</b> 7X $\frac{3}{4}$ Euro	72	1	St. MZ	<b>330,58</b>
	<b>1088051</b> 8X $\frac{3}{4}$ Euro	72	1	St. MZ	<b>365,70</b>
	<b>1088052</b> 9X $\frac{3}{4}$ Euro	72	1	St. MZ	<b>399,48</b>
	<b>1088053</b> 10X $\frac{3}{4}$ Euro	48	1	St. MZ	<b>440,26</b>
	<b>1088054</b> 11X $\frac{3}{4}$ Euro	48	1	St. MZ	<b>474,04</b>
	<b>1088055</b> 12x $\frac{3}{4}$ Euro	48	1	St. MZ	<b>506,41</b>
	<b>1088868</b> 13x $\frac{3}{4}$ Euro	48	1	St. MZ	<b>662,58</b>
	<b>1088869</b> 14x $\frac{3}{4}$ Euro	36	1	St. MZ	<b>710,25</b>
	<b>1088870</b> 15X $\frac{3}{4}$ Euro	36	1	St. MZ	<b>766,66</b>
	<b>1088871</b> 16X $\frac{3}{4}$ Euro	36	1	St. MZ	<b>893,14</b>

## Uponor Vario S Thermoantrieb Edelstahlv. NC

	<b>1013008</b> 24V FT30x1,5	10	1	St. MZ	<b>43,83</b>
	<b>1013006</b> 230V FT30x1,5	10	1	St. MZ	<b>43,83</b>

## Uponor Vario Differenzdruckregler Compact

	<b>NEU</b> <b>1137437</b> G1 - G1	125	1	Set MZ	<b>497,26</b>
---	-----------------------------------	-----	---	-----------	---------------

## Uponor Vario Regulierventil G1-Rp1

	<b>NEU</b> <b>1137413</b>	10	1	Set MZ	<b>139,45</b>
---	---------------------------	----	---	-----------	---------------

## Uponor Vario Bezeichnungsschilder

	<b>1005063</b> 47x10mm	-	1	Set MZ	<b>38,81</b>
---	------------------------	---	---	-----------	--------------

Art-Nr.	Dimension	LE	VE	ME RG	Preis/ME
---------	-----------	----	----	----------	----------

## Uponor Vario Kugelhahn

	<b>1059132</b> NP G1-G1	10	1	Set D1	<b>46,37</b>
---	-------------------------	----	---	-----------	--------------

## Uponor Vario Kugelhahn

	<b>1086558</b> $\frac{3}{4}$ -G1	10	1	Set MZ	<b>40,51</b>
---	----------------------------------	----	---	-----------	--------------

## Uponor Vario Eck-Kugelhahn

	<b>1086559</b> Rp $\frac{3}{4}$ " - G1"	-	1	Set MZ	<b>80,18</b>
	<b>1090732</b> G1-Rp1	260	1	Set D1	<b>74,74</b>

## Uponor Vario Anschlussstück

	<b>1058573</b> G1-G1A	30	1	St. MZ	<b>27,44</b>
---	-----------------------	----	---	-----------	--------------

## Uponor Vario VL-Feinregulierventil

	<b>1005107</b> $\frac{1}{2}$ " - G $\frac{3}{4}$	50	1	St. MZ	<b>40,00</b>
---	--	----	---	-----------	--------------

## Uponor Vario RL-Ventil

	<b>1005108</b> $\frac{1}{2}$ " - G $\frac{3}{4}$	50	1	St. MZ	<b>34,11</b>
--	--	----	---	-----------	--------------

## Uponor Vario WMZ - Anschluss horizontal

	<b>1090730</b> G $\frac{3}{4}$ " 110mm	250	1	Set D1	<b>156,17</b>
	<b>1090728</b> G1" 130mm	-	1	Set D1	<b>244,22</b>

## Uponor Vario WMZ - Anschlusset vertikal

	<b>1090731</b> G $\frac{3}{4}$ " 110mm	250	1	Set D1	<b>228,61</b>
	<b>1090729</b> G1" 130mm	250	1	Set D1	<b>254,09</b>

## Uponor Aqua PLUS Verteilerkappe mit Dichtung

	<b>1001337</b> $\frac{3}{4}$ "FT	250	10	St. F1	<b>6,78</b>
---	----------------------------------	-----	----	-----------	-------------

## Uponor Vario S S-Thermometer

	<b>1086537</b>	10	1	Set U1	<b>36,93</b>
---	----------------	----	---	-----------	--------------

## Uponor Vario S Verteiler Kappenventil LS

	<b>1088056</b>	-	10	St. U1	<b>9,47</b>
---	----------------	---	----	-----------	-------------

## Uponor Vario S S Verteiler Durchflussmesser.

	<b>1087608</b>	-	10	St. U1	<b>22,30</b>
---	----------------	---	----	-----------	--------------

# Verteilerschränke Einbaumaße

## Bestückungsoptionen und Einbaumaße für Uponor Verteiler Vario PLUS, Vario M und Vario S

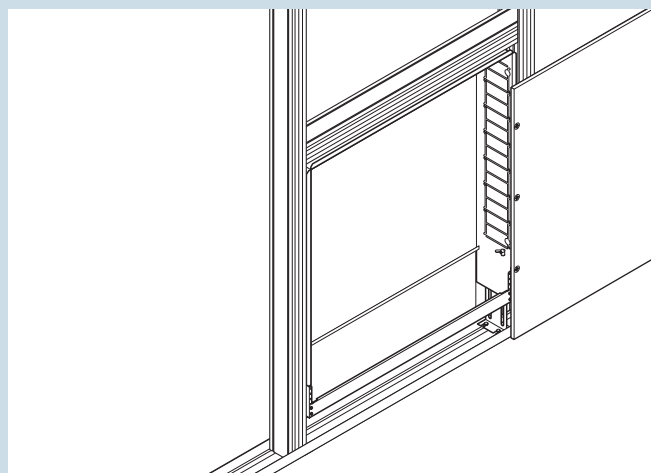
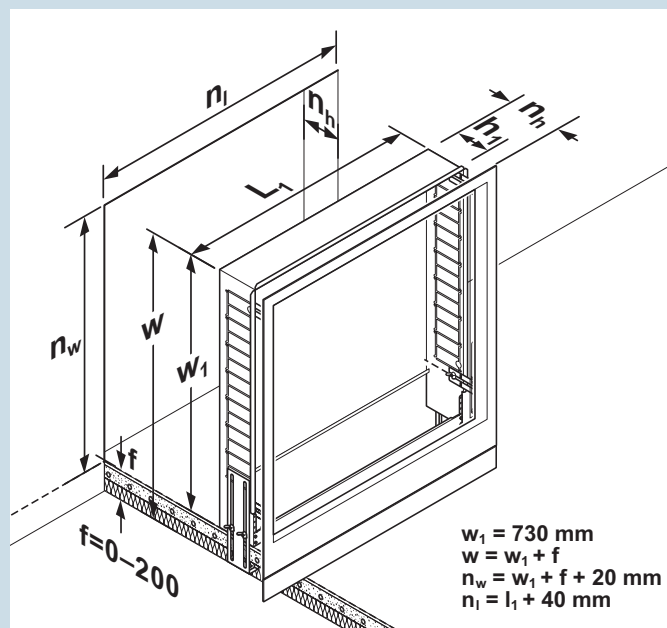

mit Uponor Vario PLUS Verteiler	Variante	Anschlusssituation	Verteilerschrank Breite $l_1$ (mm)						$h_1$ (mm)	$n_h$ min. (mm)
			550	700	850	1000	1150	1300		
geeignet für Anzahl Heizkreise										
	1	Vertikal (ohne Vario WMZ-Anschlussset)	2-4	5-7	8-10	11-13	14-15	-	80	80*
	2	Vertikal (mit Vario WMZ-Anschlussset)	2-4	5-7	8-10	11-13	14-15	-	80	95
	3	Seitlich (ohne Vario WMZ-Anschlussset)	2-5	6-8	9-11	12-14	15	-	80	80*
	4	Seitlich (mit Vario WMZ-Anschlussset)	-	2-3	4-6	7-9	10-12	13-15	80	95
	5	Mit Pumpengruppe Push 23 B	2-3	4-6	7-9	10-12	13-15	-	110	110*
	6	Mit Pumpengruppe MPG 10 / Push 23 A	-	2-4	5-7	8-10	11-13	14-15	110	110*
	7	Seitlich mit Viva Diff.-druckregler und WMZ	-	2	3-5	6-8	9-11	12-14	80	80*
	8	Vertikal mit Viva Diff.-druckregler und WMZ	-	2-3	4-6	7-9	10-12	13-15	80	95

mit Uponor Vario M Verteiler	Variante	Anschlusssituation	Verteilerschrank Breite $l_1$ (mm)						$h_1$ (mm)	$n_h$ min. (mm)
			550	700	850	1000	1150	1300		
geeignet für Anzahl Heizkreise										
	1	Vertikal (ohne Vario WMZ-Anschlussset)	2-5	6-8	9-10	11-13	14-15	-	80	80*
	2	Vertikal (mit Vario WMZ-Anschlussset)	2-5	6-8	9-10	11-13	14-15	-	80	95
	3	Seitlich (ohne Vario WMZ-Anschlussset)	2-6	7-9	10-11	12-14	15	-	80	80*
	4	Seitlich (mit Vario WMZ-Anschlussset)	-	2-4	5-7	8-10	11-12	13-15	80	95
	5	Mit Pumpengruppe Push 23 B	2-4	5-7	8-10	11-12	13-15	-	110	110*
	6	Mit Pumpengruppe MPG 10 / Push 23 A	-	2-4	5-7	8-10	11-13	14-15	110	110*
	7	Seitlich mit Viva Diff.-druckregler und WMZ	-	2-3	4-6	7-9	10-11	12-14	80	80*
	8	Vertikal mit Viva Diff.-druckregler und WMZ	-	2-4	5-7	8-10	11-12	13-15	80	95

mit Uponor Vario S Verteiler	Variante	Anschlusssituation	Verteilerschrank Breite $l_1$ (mm)						$h_1$ (mm)	$n_h$ min. (mm)
			550	700	850	1000	1150	1300		
geeignet für Anzahl Heizkreise										
	1	Vertikal (ohne Vario WMZ-Anschlussset)	2-5	6-8	9-11	12-14	15-16	-	80	80*
	2	Vertikal (mit Vario WMZ-Anschlussset)	2-5	6-8	9-11	12-14	15-16	-	80	95
	3	Seitlich (ohne Vario WMZ-Anschlussset)	2-6	7-9	10-12	13-15	16	-	80	80*
	4	Seitlich (mit Vario WMZ-Anschlussset)	-	2-4	5-7	8-10	11-13	14-16	80	95
	5	Mit Pumpengruppe Push 23 B	2-4	5-7	8-10	11-13	14-16	-	110	110*
	6	Mit Pumpengruppe MPG 10 / Push 23 A	-	2-4	5-7	8-10	11-13	14-16	110	110*
	7	Seitlich mit Viva Diff.-druckregler und WMZ	-	2-3	4-6	7-9	10-12	13-15	80	80*
	8	Vertikal mit Viva Diff.-druckregler und WMZ	-	2-4	5-7	8-10	11-13	14-16	80	95

\* plus 10 mm bei Einsatz der Kunststofftür

# Uponor Vario

Art-Nr.	Dimension	LE	VE	ME RG	Preis/ME
---------	-----------	----	----	----------	----------

## Uponor Vario Verteilerschrank IW

 <b>1093491</b>	550x730x110mm	18	1	St. MZ	<b>123,50</b>
<b>1093492</b>	700x730x110mm	16	1	St. MZ	<b>140,05</b>
<b>1093493</b>	850x730x110mm	13	1	St. MZ	<b>152,50</b>
<b>1093494</b>	1000x730x110mm	12	1	St. MZ	<b>176,68</b>
<b>1093495</b>	1150x730x110mm	8	1	St. MZ	<b>199,57</b>
<b>1093496</b>	1300x730x110mm	8	1	St. MZ	<b>211,31</b>

## Uponor Vario Verteilerschrank IW

 <b>1093497</b>	550x730x80mm	28	1	St. MZ	<b>116,22</b>
<b>1093498</b>	700x730x80mm	25	1	St. MZ	<b>134,42</b>
<b>1093499</b>	850x730x80mm	19	1	St. MZ	<b>150,85</b>
<b>1093500</b>	1000x730x80mm	18	1	St. MZ	<b>171,63</b>
<b>1093501</b>	1150x730x80mm	12	1	St. MZ	<b>200,75</b>
<b>1093502</b>	1300x730x80mm	12	1	St. MZ	<b>211,31</b>

## Uponor Vario Schrank Rahmen/Tür IW S

 <b>1093528</b>	550x730mm	35	1	St. MZ	<b>127,51</b>
<b>1093541</b>	700x730mm	30	1	St. MZ	<b>153,33</b>
<b>1093542</b>	850x730mm	25	1	St. MZ	<b>172,99</b>
<b>1093543</b>	1000x730mm	20	1	St. MZ	<b>203,94</b>
<b>1093544</b>	1150x730mm	15	1	St. MZ	<b>234,88</b>
<b>1093546</b>	1300x730mm	15	1	St. MZ	<b>271,46</b>

## Uponor Vario Schrank Rahmen/Tür IW P

 <b>1093547</b>	550x730mm	35	1	St. MZ	<b>340,45</b>
<b>1093548</b>	700x730mm	30	1	St. MZ	<b>422,63</b>
<b>1093549</b>	850x730mm	25	1	St. MZ	<b>504,81</b>
<b>1093550</b>	1000x730mm	20	1	St. MZ	<b>540,02</b>
<b>1093551</b>	1150x730mm	15	1	St. MZ	<b>622,20</b>
<b>1093552</b>	1300x730mm	15	1	St. MZ	<b>585,80</b>

## Uponor Vario Zylinderschloss 2 Schlüssel

 <b>1093554</b>		200	1	St. U1	<b>60,44</b>
--	--	-----	---	-----------	--------------

## Uponor Vario Schiene

 <b>1093555</b>		200	1	St. U1	<b>13,94</b>
--	--	-----	---	-----------	--------------

Art-Nr.	Dimension	LE	VE	ME RG	Preis/ME
---------	-----------	----	----	----------	----------

## Uponor Vario Halterungsset

 <b>OUT</b> <b>1093522</b> (5pcs)		200	1	St. U1	<b>13,21</b>
--	--	-----	---	-----------	--------------

Lieferung solange Vorrat reicht. Artikel läuft im Laufe des Jahres aus.

## Uponor Vario Verteilerschrank OW

 <b>NEU</b> <b>1136215</b>	450x730x135	25	1	St. MZ	<b>205,39</b>
<b>NEU</b> <b>1136216</b>	600x730x135	17	1	St. MZ	<b>243,33</b>
<b>NEU</b> <b>1136217</b>	750x730x135	15	1	St. MZ	<b>264,85</b>
<b>NEU</b> <b>1136218</b>	900x730x135	12	1	St. MZ	<b>302,68</b>
<b>NEU</b> <b>1136219</b>	1050x730x135	11	1	St. MZ	<b>335,11</b>
<b>NEU</b> <b>1136220</b>	1200x730x135	7	1	St. MZ	<b>367,54</b>
<b>NEU</b> <b>1136221</b>	1350x730x135	7	1	St. MZ	<b>395,25</b>
<b>NEU</b> <b>1136222</b>	1550x730x135	7	1	St. MZ	<b>443,21</b>

## Uponor Vario Schrankrückwand OW

 <b>NEU</b> <b>1136223</b>	450x730	5	1	St. MZ	<b>169,72</b>
<b>NEU</b> <b>1136224</b>	600x730	5	1	St. MZ	<b>193,50</b>
<b>NEU</b> <b>1136225</b>	750x730	5	1	St. MZ	<b>227,01</b>
<b>NEU</b> <b>1136226</b>	900x730	5	1	St. MZ	<b>257,28</b>
<b>NEU</b> <b>1136227</b>	1050x730	5	1	St. MZ	<b>285,38</b>
<b>NEU</b> <b>1136228</b>	1200x730	5	1	St. MZ	<b>310,25</b>
<b>NEU</b> <b>1136229</b>	1350x730	5	1	St. MZ	<b>329,71</b>
<b>NEU</b> <b>1136230</b>	1550x730	5	1	St. MZ	<b>372,95</b>

## Uponor Vario Verteilerschrank Aufputz AP

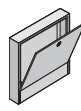
 <b>OUT</b> <b>1045478</b>	600x156mm	11	1	St. MZ	<b>243,33</b>
<b>OUT</b> <b>1045479</b>	800x156mm	10	1	St. MZ	<b>272,91</b>
<b>OUT</b> <b>1045480</b>	1000x156mm	9	1	St. MZ	<b>327,74</b>
<b>OUT</b> <b>1045481</b>	1350x156mm	8	1	St. MZ	<b>395,25</b>

Lieferung solange Vorrat reicht. Artikel läuft im Laufe des Jahres aus.

## Uponor Vario Schrankrückwand AP

 <b>OUT</b> <b>1045482</b>	580mm	15	1	St. MZ	<b>138,84</b>
<b>OUT</b> <b>1045483</b>	780mm	30	1	St. MZ	<b>166,00</b>
<b>OUT</b> <b>1045484</b>	980mm	20	1	St. MZ	<b>182,88</b>
<b>OUT</b> <b>1045485</b>	1330mm	-	1	St. MZ	<b>241,93</b>

Lieferung solange Vorrat reicht. Artikel läuft im Laufe des Jahres aus.

## Uponor Magna Verteilerschrank Aufputz

 <b>1060553</b>	1010x835x200mm	-	1	St. MZ	<b>428,50</b>
<b>1060554</b>	1910x835x200mm	-	1	St. MZ	<b>582,76</b>
<b>1060555</b>	2310x835x200mm	-	1	St. MZ	<b>645,68</b>

Installation

Flächenheizung  
und -kühlung

Nahwärme-  
versorgung

Werkzeuge

Anhang

# Uponor Smatrix

## Systemfinder Uponor Einzelraumregelungen für Flächenheizung/-kühlung im Wohnungsbau

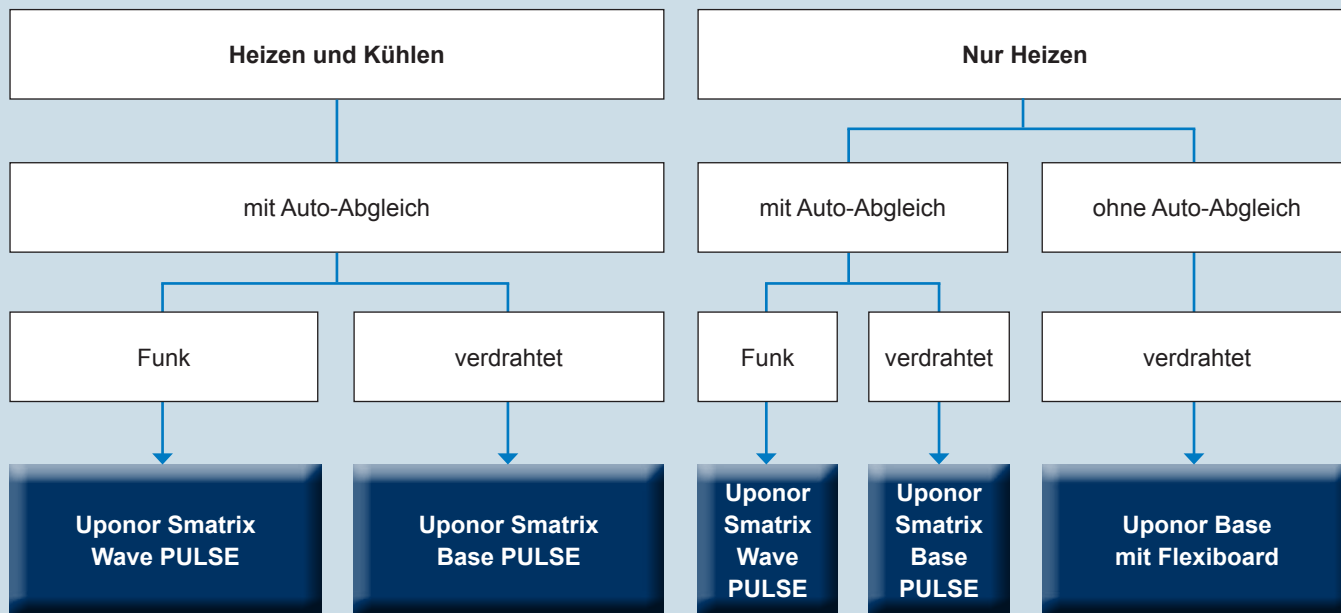

## Einzelraumregelungen Wohnungsbau

Die Uponor Regelung	... ist eine:
<b>Uponor Smatrix Wave PULSE</b>	per App gesteuerte Funk-Einzelraumregelung zum Heizen und Kühlen mit vielen Features, z.B. Anbindung an Smart Home ( <i>Amazon Alexa, Google Home</i> ) mit R-208 und Cloud
<b>Uponor Smatrix Wave</b>	Funk-Raumtemperaturregelung für die Flächenheizung und -kühlung
<b>Uponor Smatrix Base PULSE</b>	per App gesteuerte kabelgebundene Einzelraumregelung zum Heizen und Kühlen mit vielen Features, z.B. Anbindung an Smart Home ( <i>Amazon Alexa, Google Home</i> ) mit R-208 und Cloud
<b>Uponor Smatrix Base PRO</b>	kabelgebundene Einzelraumregelung zum Heizen und Kühlen mit bis zu 16 Regelmodulen für den Gewerbebau und für große Objekte
<b>Uponor Base</b>	konventionelle verdrahtete 230 V Einzelraumregelung zur einfachen Raumtemperaturregelung
<b>Uponor Space</b>	einfach zu bedienende Raumtemperaturregelung für Kühldecken mit Taupunktüberwachung
<b>Uponor Smatrix Style</b>	Design-Raumfühler mit Feuchteüberwachung für Smatrix Wave/Base PULSE und Smatrix Base PRO Einzelraumregelung
<b>Smatrix Move</b>	witterungsgeführter Vorlauftemperaturregler zum Heizen und Kühlen
<b>Smatrix Move PRO</b>	witterungsgeführter Mehrzonen-Vorlauftemperaturregler für den Gewerbebau zum Heizen oder Heizen/Kühlen und zusätzlich mit Schnee- und Eisfreihaltung

# Uponor Smatrix

## Funktionsumfang Smatrix Wave/Base

Uponor Smatrix Regelungstechnik	Komplettversion		ohne Cloud		nur Regelmodul	
	 Smatrix Wave PULSE	 Smatrix Base PULSE	 Smatrix Wave PULSE	 Smatrix Base PULSE	 Smatrix Wave PULSE	 Smatrix Base PULSE
Fernzugriff	■	■				
Komfoteinstelluwnng	■	■				
Absenprogramme	■	■				
Updates per App	■	■				
Einbindung ( <i>Amazon Alexa, Google Home</i> ) mit R-208	■	■				
Fernschaltung weiterer Anlagenkomponenten per Relaismodul	■					
Lokaler Zugriff über WLAN	■	■	■	■		
Max./Min.-Begrenzung der Sollwerttemperatur	■	■	■	■		
Einrichten einer Regelungsgruppe aus 4 Regelmodulen	■	■	■	■		
Erweiterte Heizen/ Kühlen-Umschaltmöglichkeiten	■	■	■	■		
Zentraler Absenkmodus	■	■	■	■		
Auto-Abgleich	■	■	■	■	■	■
Heizen und Kühlen	■	■	■	■	■	■
RF Schalterleiste		■		■		■
Regelung von Heizkörpern	■	■	■	■	■	■

Installation

Flächenheizung und -kühlung

Nahwärmeversorgung

Werkzeuge

Anhang

# Uponor Smatrix Move PRO

Art-Nr.	Dimension	LE	VE	ME RG	Preis/ME
---------	-----------	----	----	----------	----------

## Uponor Smatrix Move PRO Regler X-159

 1087155		10	1	St. MZ	2968,25
---	--	----	---	-----------	---------

## Uponor Smatrix Move PRO Schnee-Eis Set S-152 + S-158

 1087158		-	1	Set MZ	3164,75
1087156		5	1	St. MZ	1547,22

## Uponor Smatrix Move PRO Raumfühler S-155

 1087159		10	1	St. MZ	181,46
---	--	----	---	-----------	--------

Art-Nr.	Dimension	LE	VE	ME RG	Preis/ME
---------	-----------	----	----	----------	----------

## Uponor Smatrix Move PRO Feuchtfühler S-157

 1087160		75	1	St. MZ	738,43
---	--	----	---	-----------	--------

## Uponor Smatrix Move PRO Kondensschutz S-159

 1087165		10	1	Set MZ	717,21
---	--	----	---	-----------	--------

# Uponor Smatrix Move

## Uponor Smatrix Move Regler X-157 Wired

 1071693		4	1	Set MZ	1195,54
---	--	---	---	-----------	---------

## Uponor Smatrix Move Antenne A-155 Radio

 1071676		21	1	St. U1	237,28
---	--	----	---	-----------	--------

## Uponor Smatrix Move Vorl./Rücklauffühler S-152

 1071661	3m	63	1	St. MZ	114,37
---	----	----	---	-----------	--------

## Uponor Smatrix Move Außenfühler S-1XX

 1071671		45	1	St. MZ	147,70
---	--	----	---	-----------	--------

## Uponor Smatrix Schaltmodul H/K M-1XX

 1083577	230V	16	1	St. MZ	198,32
---	------	----	---	-----------	--------

## Uponor Fluvia Move PLUS Mischermotor 230V

 1119812		10	1	St. U1	393,47
---	--	----	---	-----------	--------

## Uponor Smatrix Move Mischermotor 230V

 1002357		-	1	St. MZ	302,18
---	--	---	---	-----------	--------

# Uponor Fluvia

Art-Nr.	Dimension	LE	VE	ME RG	Preis/ME
---------	-----------	----	----	----------	----------

## Uponor Fluvia T Pumpengruppe Push-12 TH-G

 1095127		60	1	St. MZ	794,71
---	--	----	---	-----------	--------

## Uponor Fluvia T Pumpengruppe Push-12 CH-G

 1095131		30	1	St. MZ	1870,88
---	--	----	---	-----------	---------

## Uponor Fluvia T Regeleinheit Push-12-CH-X

 1085982		50	1	St. MZ	1054,83
---	--	----	---	-----------	---------

## Uponor Fluvia T Pumpengruppe Push-12 AC-G

 1095128		60	1	St. MZ	942,45
---	--	----	---	-----------	--------

## Uponor Fluvia T Pumpengruppe Push-12 WL-G

 1095130		60	1	St. MZ	1258,84
---	--	----	---	-----------	---------

## Uponor Fluvia Hosenstück

 1005675	2xG $\frac{3}{4}$ - $\frac{3}{4}$ "Euro	50	1	Set MZ	48,72
---	---	----	---	-----------	-------

## Uponor Vario Füll-/Entleerungshahn

 1061802	$\frac{3}{4}$ " - $\frac{3}{4}$ "	10	1	Set MZ	75,81
---	-----------------------------------	----	---	-----------	-------

## Uponor Aqua PLUS Verteilerkappe mit Dichtung

 1001337	$\frac{3}{4}$ "FT	250	10	St. F1	6,78
---	-------------------	-----	----	-----------	------

## Uponor Fluvia T Grundfos Pumpenkopf Push-12

 1095132		20	1	St. U1	375,81
---	--	----	---	-----------	--------

## Uponor Fluvia Ventil für Push 12

 1059851		-	1	St. U1	176,79
---	--	---	---	-----------	--------

## Uponor Fluvia Thermostat f. 1059834 Push-12 TH

 1059852		-	1	St. U1	148,63
---	--	---	---	-----------	--------

Art-Nr.	Dimension	LE	VE	ME RG	Preis/ME
---------	-----------	----	----	----------	----------

## Uponor Fluvia Move Pumpengruppe Push-23-A-AC

 1085008		30	1	St. MZ	1927,16
---	--	----	---	-----------	---------

## Uponor Fluvia T Pumpengruppe Push-23-B-W

 <b>NEU</b> 1078304		55	1	St. MZ	1244,72
--	--	----	---	-----------	---------

## Uponor Fluvia T Thermostat m. Fernfühler Push-23

 1063461		-	1	St. U1	143,71
---	--	---	---	-----------	--------

## Uponor Fluvia Rücklauf-Regulierventil Push-23

 1059282		10	1	St. U1	55,48
---	--	----	---	-----------	-------

## Uponor Fluvia Vorlauf-Thermostatventil Push-23

 1059283		10	1	St. U1	55,48
---	--	----	---	-----------	-------

## Uponor Fluvia Mischventil für Push-23

 1061525	$\frac{3}{4}$ x G1 x G1	-	1	St. U1	141,76
---	-------------------------	---	---	-----------	--------

Installation

Flächenheizung  
und -kühlungNahwärme-  
versorgung

Werkzeuge

Anhang



# Uponor Fluvia

Art-Nr.	Dimension	LE	VE	ME RG	Preis/ME
---------	-----------	----	----	----------	----------

## Uponor Fluvia Move Pumpengruppe MPG-10-A-W

 <b>NEU</b>	1078306	30	1	St. MZ	3826,35
--	---------	----	---	-----------	---------

## Uponor Fluvia Pumpengruppe MPG-10-B-W

 <b>NEU</b>	1078307	30	1	St. MZ	1603,64
--	---------	----	---	-----------	---------

## Uponor Fluvia Pumpe Wilo Para SC

	1095309	6m, 180mm	-	1	St. U1	786,96
---	---------	-----------	---	---	-----------	--------

## Uponor Vario Anschlussstück

	1058573	G1-G1A	30	1	St. MZ	27,44
---	---------	--------	----	---	-----------	-------

## Uponor Fluvia Mischventil für 1048780 MPG

	1071964		-	1	St. U1	284,99
---	---------	--	---	---	-----------	--------

## Uponor Fluvia Move Pumpengruppe CPG-15-C-W

	1119445		18	1	St. MZ	2630,09
---	---------	--	----	---	-----------	---------

## Uponor Fluvia Pumpengruppe CPG-15-D-W

	1119448		18	1	St. MZ	1335,28
---	---------	--	----	---	-----------	---------

Art-Nr.	Dimension	LE	VE	ME RG	Preis/ME
---------	-----------	----	----	----------	----------

## Uponor Fluvia Dreiwegemischer CPG, EPG

	1119813		10	1	St. U1	236,09
---	---------	--	----	---	-----------	--------

## Uponor Fluvia Move PLUS Mischermotor 230V

	1119812		10	1	St. U1	393,47
---	---------	--	----	---	-----------	--------

## Uponor Fluvia Max.-Begrenzungstherm.

	1005504	5-60		10	1	St. MZ	81,87
---	---------	------	--	----	---	-----------	-------

## Uponor Fluvia Move Pumpengruppe PPG-30-A-W

	1084143		22	1	St. MZ	4374,92
---	---------	--	----	---	-----------	---------

## Uponor Fluvia Move Pumpengruppe EPG-6-A-W

	1078310		8	1	St. MZ	5190,68
--	---------	--	---	---	-----------	---------

## Uponor Smatrix Move Mischermotor 24V (0-10V) pro

	1002356	A-15X 24V 0-10 V		-	1	St. MZ	538,96
---	---------	------------------	--	---	---	-----------	--------

## Uponor Smatrix Move Mischermotor 230V

	1002357			-	1	St. MZ	302,18
---	---------	--	--	---	---	-----------	--------

# Uponor Smatrix Wave / Pulse

Art-Nr.	Dimension	LE	VE	ME RG	Preis/ME
---------	-----------	----	----	----------	----------

## Uponor Smatrix Wave Starter-Set Pulse S

 1093284		3	1	Set MZ	1758,20
---	--	---	---	-----------	---------

## Uponor Smatrix Wave Starter-Set Pulse L

 1093287		2	1	Set MZ	2714,48
---	--	---	---	-----------	---------

## Uponor Smatrix Schnittstelle Pulse com R-208

 1093030		16	1	St. MZ	686,49
---	--	----	---	-----------	--------

## Uponor Smatrix Wave Regelmodul Pulse X-265 6X

 1093021		4	1	St. MZ	541,54
---	--	---	---	-----------	--------

## Uponor Smatrix Wave Slave-Modul Pulse M-262 6X

 1093133		16	1	St. MZ	138,84
---	--	----	---	-----------	--------



## Uponor Smatrix Wave Antenne Pulse A-265

 1093028		16	1	St. U1	310,39
---	--	----	---	-----------	--------

## Uponor Smatrix Wave Funk Schaltmodul M-161

 1071673	2X	16	1	St. MZ	164,57
---	----	----	---	-----------	--------

## Uponor Smatrix Wave RT-Feuchtefühler Style T-169

 1087816	weiß	180	1	St. MZ	241,93
 1087817	schwarz	180	1	St. MZ	241,93

## Uponor Smatrix Wave RT-Feuchtefühler Style T-161

 1087815		180	1	St. MZ	225,08
---	--	-----	---	-----------	--------

Art-Nr.	Dimension	LE	VE	ME RG	Preis/ME
---------	-----------	----	----	----------	----------

## Uponor Smatrix Wave Raumfühler prog.+RH T-168

 1086984	RAL9016	75	1	St. MZ	216,60
---	---------	----	---	-----------	--------

## Uponor Smatrix Wave Raumfühler digit. T-166

 1086982	RAL9016	75	1	St. MZ	191,28
---	---------	----	---	-----------	--------

## Uponor Smatrix Wave Raumfühler T-165 POD

 1086981	RAL9016	75	1	St. MZ	157,54
---	---------	----	---	-----------	--------

## Uponor Smatrix Wave Raumfühler BM T-163

 1086979	RAL9016	75	1	St. MZ	208,16
---	---------	----	---	-----------	--------

## Uponor Smatrix Wave Thermostatkopf T-162

 1071660		16	1	St. MZ	150,73
---	--	----	---	-----------	--------

## Uponor Smatrix Wandrahmen T-X A-1XX

 1086986	RAL9016	250	1	St. MZ	9,15
---	---------	-----	---	-----------	------

## Uponor Smatrix Boden- oder Fernfühler S-1XX

 1071684		63	1	St. MZ	48,10
---	--	----	---	-----------	-------

## Uponor Smatrix Schaltmodul H/K M-1XX

 1083576	24V	84	1	St. MZ	182,86
---	-----	----	---	-----------	--------

## Uponor Smatrix Schaltmodul H/K M-1XX

 1083577	230V	16	1	St. MZ	198,32
---	------	----	---	-----------	--------

## Uponor Vario Thermoantrieb Retrofit A-XXX

 1083575	24V, NC, 1W	100	1	Set MZ	69,64
---	-------------	-----	---	-----------	-------

Installation

Flächenheizung  
und -kühlungNahwärme-  
versorgung

Werkzeuge

Anhang

# Uponor Smatrix Base / Pulse

Art-Nr.	Dimension	LE	VE	ME RG	Preis/ME
---------	-----------	----	----	----------	----------

## Uponor Smatrix Base Starter-Set Pulse S

 <b>1093280</b>		3	1	Set MZ	<b>1533,38</b>
--	--	---	---	-----------	----------------

## Uponor Smatrix Base Starter-Set Pulse L

 <b>1093282</b>		2	1	Set MZ	<b>2264,81</b>
--	--	---	---	-----------	----------------

## Uponor Smatrix Schnittstelle Pulse com R-208

 <b>1093030</b>		16	1	St. MZ	<b>686,49</b>
--	--	----	---	-----------	---------------

## Uponor Smatrix Base Regelmodul Pulse X-245 BUS 6X

 <b>1093017</b>		4	1	St. MZ	<b>365,72</b>
--	--	---	---	-----------	---------------



## Uponor Smatrix Base Slave-Modul Pulse M-242 BUS 6X

 <b>1093134</b>		16	1	St. MZ	<b>124,21</b>
---	--	----	---	-----------	---------------

## Uponor Smatrix Base Stern-Modul Pulse M-243 BUS 6X

 <b>1093135</b>		16	1	St. MZ	<b>94,96</b>
--	--	----	---	-----------	--------------

## Uponor Smatrix Base RT-Feuchtfühler Style T-149 Bus

 <b>1087813</b> weiß		180	1	St. MZ	<b>225,08</b>
 <b>1087814</b> schwarz		180	1	St. MZ	<b>225,08</b>

## Uponor Smatrix Base PRO RT-Feuchtfühler Style T-141 Bus

 <b>1087812</b> FLUSH		180	1	St. MZ	<b>127,87</b>
--	--	-----	---	-----------	---------------

## Uponor Smatrix Base Wandrahmen T-141

 <b>1122237</b>		20	1	St. MZ	<b>6,70</b>
--	--	----	---	-----------	-------------

## Uponor Smatrix Base Raumfühler prog.+RH T-148 Bus

 <b>1086977</b> RAL9016		75	1	St. MZ	<b>142,04</b>
--	--	----	---	-----------	---------------

Art-Nr.	Dimension	LE	VE	ME RG	Preis/ME
---------	-----------	----	----	----------	----------

## Uponor Smatrix Base Raumfühler digit. T-146 Bus

 <b>1086976</b> RAL9016		75	1	St. MZ	<b>130,96</b>
--	--	----	---	-----------	---------------

## Uponor Smatrix Base Raumthermostat T-145 Bus POD

 <b>1086975</b> RAL9016		75	1	St. MZ	<b>64,70</b>
--	--	----	---	-----------	--------------

## Uponor Smatrix Base Raumfühler UP T-144 Bus

 <b>1086973</b> RAL9016		60	1	St. MZ	<b>102,82</b>
--	--	----	---	-----------	---------------



## Uponor Smatrix Base Raumfühler BM T-143 Bus

 <b>1086972</b> RAL9016		75	1	St. MZ	<b>89,46</b>
--	--	----	---	-----------	--------------

## Uponor Smatrix Boden- oder Fernfühler S-1XX

 <b>1071684</b>		63	1	St. MZ	<b>48,10</b>
--	--	----	---	-----------	--------------

## Uponor Smatrix Base Aufputz-Wandrahmen Style T-149 A-14X

 <b>1087821</b> weiß		90	1	St. MZ	<b>9,63</b>
 <b>1087822</b> schwarz		90	1	St. MZ	<b>10,92</b>

## Uponor Smatrix Wandrahmen T-X A-1XX

 <b>1086986</b> RAL9016		250	1	St. MZ	<b>9,15</b>
--	--	-----	---	-----------	-------------

## Uponor Smatrix Base Bus-Kabel A-145

 <b>1071670</b> 50m		2	1	St. MZ	<b>186,89</b>
--	--	---	---	-----------	---------------

## Uponor Smatrix Schaltmodul H/K M-1XX

 <b>1083576</b> 24V		84	1	St. MZ	<b>182,86</b>
--	--	----	---	-----------	---------------

## Uponor Smatrix Schaltmodul H/K M-1XX

 <b>1083577</b> 230V		16	1	St. MZ	<b>198,32</b>
---	--	----	---	-----------	---------------

## Uponor Vario Thermoantrieb Retrofit A-XXX

 <b>1083575</b> 24V, NC, 1W		100	1	Set MZ	<b>69,64</b>
--	--	-----	---	-----------	--------------

# Uponor Smatrix Base PRO

Art-Nr.	Dimension	LE	VE	ME RG	Preis/ME
---------	-----------	----	----	----------	----------

## Uponor Smatrix Base PRO Regler X-147 Bus

 1087162	6X	4	1	St. MZ	808,75
---	----	---	---	-----------	--------

## Uponor Smatrix Base Erweiterungsmodul M-140 Bus

 1071686	6X	16	1	St. MZ	97,91
---	----	----	---	-----------	-------

## Uponor Smatrix Base Stern Modul M-141 Bus

 1071651	8X	16	1	St. MZ	114,37
---	----	----	---	-----------	--------

## Uponor Smatrix Base PRO Bedienmodul I-147 Bus

 1087161		7	1	St. MZ	780,68
---	--	---	---	-----------	--------

Art-Nr.	Dimension	LE	VE	ME RG	Preis/ME
---------	-----------	----	----	----------	----------

## Uponor Smatrix Base PRO RT-Feuchtefühler Style T-141 Bus

 1087812	FLUSH	180	1	St. MZ	127,87
---	-------	-----	---	-----------	--------

## Uponor Smatrix Base Wandrahmen T-141

 1122237		20	1	St. MZ	6,70
---	--	----	---	-----------	------

## Uponor Smatrix Base PRO KNX Schnittst. R-147 KNX

 1087164		-	1	St. MZ	1040,75
---	--	---	---	-----------	---------

Installation

Flächenheizung  
und -kühlungNahwärme-  
versorgung

Werkzeuge

Anhang

# Uponor Base

Art-Nr.	Dimension	LE	VE	ME RG	Preis/ME
---------	-----------	----	----	----------	----------

## Uponor Base 6 Kanal Regelmodul X-23

 <b>1058426</b>	6X 230V	200	1	St. MZ	<b>182,86</b>
--	---------	-----	---	-----------	---------------

## Uponor Base flexiboard X-24

 <b>1088331</b>	6X 230V	-	1	St. MZ	<b>216,62</b>
--	---------	---	---	-----------	---------------

## Uponor Base flexiboard mit Pumpenlogik X-25

 <b>1089086</b>	6X 230V	-	1	St. MZ	<b>227,84</b>
--	---------	---	---	-----------	---------------

## Uponor Base flexiboard X-26

 <b>1089087</b>	8X 230V	-	1	St. MZ	<b>240,54</b>
--	---------	---	---	-----------	---------------

## Uponor Base flexiboard mit Pumpenlogik X-27

 <b>1089088</b>	8X 230V	-	1	St. MZ	<b>264,46</b>
--	---------	---	---	-----------	---------------

Art-Nr.	Dimension	LE	VE	ME RG	Preis/ME
---------	-----------	----	----	----------	----------

## Uponor Base Raumfühler T-23

 <b>1058422</b>	230V RAL9010	160	1	St. MZ	<b>57,25</b>
--	--------------	-----	---	-----------	--------------

## Uponor Base Raumfühler UP T-24

 <b>1058423</b>	230V	-	1	St. MZ	<b>107,33</b>
--	------	---	---	-----------	---------------

## Uponor Base Raumfühler H/K T-25

 <b>1058424</b>	230V	-	1	St. MZ	<b>80,03</b>
--	------	---	---	-----------	--------------

## Uponor Base Prog. Raumfühler T-26

 <b>1058425</b>	230V RAL9010	-	1	St. MZ	<b>154,69</b>
--	--------------	---	---	-----------	---------------

## Uponor Base Fernfühler

 <b>1047459</b>	230V	-	1	St. MZ	<b>27,28</b>
--	------	---	---	-----------	--------------

## Uponor Vario B Stellantrieb NC

 <b>1022244</b>	230V FT28x1,5	10	1	St. MZ	<b>82,29</b>
--	---------------	----	---	-----------	--------------

# Uponor Space

Art-Nr.	Dimension	LE	VE	ME RG	Preis/ME
---------	-----------	----	----	----------	----------

## Uponor Space Schnittstellenkonverter TK 1PF



1000314	24V	-	1	St. B6	274,74
---------	-----	---	---	-----------	--------

## Uponor Space Taupunktfühler TF 3 PR



1000312	24V	10	1	St. B6	219,48
---------	-----	----	---	-----------	--------

## Uponor Space Taupunktfühler TF 3 GM



1000313	24V	25	1	St. B6	219,48
---------	-----	----	---	-----------	--------

Art-Nr.	Dimension	LE	VE	ME RG	Preis/ME
---------	-----------	----	----	----------	----------

## Uponor Vario VL-Feinregulierventil



1005107	½" - G¾	50	1	St. MZ	40,00
---------	---------	----	---	-----------	-------

## Uponor Vario RL-Ventil



1005108	½" - G¾	50	1	St. MZ	34,11
---------	---------	----	---	-----------	-------

Installation

Flächenheizung  
und -kühlungNahwärme-  
versorgung

Werkzeuge

Anhang







# Verbindungstechnik, Fittings und Werkzeuge für Uponor Ecoflex Rohre

Systemrohr	Abmessung [mm]	Mediumrohr	Dämmung	Mantelrohr	Temperatur- und Druckbelastung	Länge [m]	Artikel-Nr.	Zertifizierung
 VIP Thermo Single	40 x 3,7/140	PE-Xa + EVOH	VIP + PEX-Schaum	PE-HD	max. 95 °C / 6 bar	200	1095714	KOMO Systemzertifizierung  CSTB Systemzertifizierung
	50 x 4,6/140					200	1095715	
	63 x 5,8/140					200	1095716	
	75 x 6,8/140					200	1095717	
	90 x 8,2/175					150	1095718	
	110 x 10,0/175					150	1095719	
	125 x 11,4/200					120	1095720	
 VIP Thermo Twin	2x25 x 2,3/140	PE-Xa + EVOH	VIP + PEX-Schaum	PE-HD	max. 95 °C / 6 bar	200	1118580	KOMO Systemzertifizierung  CSTB Systemzertifizierung
	2x32 x 2,9/140					200	1118581	
	2x40 x 3,7/175					200	1118582	
	2x50 x 4,6/175					200	1118583	
	2x63 x 5,8/200					100	1118584	
	2x75 x 6,8/250					100	1118585	
	 Thermo Single optional mit Heizkabel					25 x 2,3/140	PE-Xa + EVOH	
32 x 2,9/140		200	1018110					
40 x 3,7/175		200	1018111					
50 x 4,6/175		200	1018112					
63 x 5,8/175		200	1018113					
75 x 6,8/200		100	1018114					
90 x 8,2/200		100	1018115					
110 x 10,0/200		100	1018116					
 Thermo Twin	2x25 x 2,3/175	PE-Xa + EVOH	PEX-Schaum	PE-HD	max. 95 °C / 6 bar	200	1018134	KOMO Systemzertifizierung, Deklaration nach DIN EN 15632, DIN CERTCO Wärmeverlustzertifizierung - Überwacht nach VDI 2055, CSTB Systemzertifizierung
	2x32 x 2,9/175					200	1018135	
	2x40 x 3,7/175					200	1018136	
	2x50 x 4,6/200					100	1018137	
	2x63 x 5,8/200					100	1018138	
 Thermo Mini	25 x 2,3/68	PE-Xa + EVOH	PEX-Schaum	PE-HD	max. 95 °C / 6 bar	200	1018132	CSTB Systemzertifizierung
	32 x 2,9/68					200	1018133	
 Thermo Twin HP* * Integrierte Leerrohre für Kabel	2x32 x 2,9-2x32 x 3,5/140	PE-Xa + EVOH	PEX-Schaum	PE-HD	max. 95 °C / 6 bar	200	1093894	
	2x40 x 3,7-2x32 x 3,5/175					200	1093895	



**Verbindungstechnik und Werkzeuge**

	<b>Wipex Übergangs-nippel</b> 	<b>Ecoflex Übergangs-nippel</b> 	<b>Quick &amp; Easy</b> 				
Zubehör	PN6 + Grafitpaste + Aufspreizzange + Inbus	PN6 + Grafitpaste + Inbus	PN6 + Grafitpaste + Inbus	Aufweitwerkzeuge M18 6 bar	M18 VLD	Ringe natural	weiß
Gummi-Endkappe							

	•			•	•	•	
	•				•	•	
		•			•	•	
		•			•	•	
		•			•	•	
		•			•	•	
			•				
	•			•			•
	•			•			•
	•			•	•	•	
	•			•	•	•	
	•			•	•	•	
	•			•	•	•	
	•			•	•	•	
		•			•	•	
		•			•	•	
		•			•	•	
		•			•	•	
		•			•	•	
	•			•			•
	•			•			•
	•			•	•	•	
	•			•	•	•	
	•			•	•	•	
	•			•			•
	•			•			•
	•			•			•
	•			•			•
	•			•			•
	•			•			•
	•			•	•	•	

Installation

Flächenheizung und -kühlung

Nahwärmeversorgung

Werkzeuge

Anhang

# Verbindungstechnik, Fittings und Werkzeuge für Uponor Ecoflex Rohre

	Systemrohr	Abmessung [mm]	Mediumrohr	Dämmung	Mantelrohr	Temperatur- und Druckbelastung	Länge [m]	Artikel-Nr.	Zertifizierung	Zubehör  Gummi-Endkappe
HEIZEN UND KÜHLEN	Varia Single 	25 x 2,3/90	PE-Xa + EVOH	PEX-Schaum	PE-HD	max. 95 °C / 6 bar	200	1018230	CSTB System-zertifizierung	
		32 x 2,9/90					200	1018231		
		40 x 3,7/140					200	1018232		
		50 x 4,6/140					200	1018233		
		63 x 5,8/140					200	1018234		
		75 x 6,8/175					200	1018235		
		90 x 8,2/175					100	1018236		
		110 x 10,0/175					100	1018237		
		125 x 11,4/200					120	1062886		
	Varia Twin 	2x25 x 2,3/140	PE-Xa + EVOH	PEX-Schaum	PE-HD	max. 95 °C / 6 bar	200	1018238	CSTB System-zertifizierung	
		2x32 x 2,9/140					200	1018239		
		2x40 x 3,7/140					200	1018240		
		2x50 x 4,6/175					200	1018241		
VIP Aqua Single 	40 x 5,5/140	PE-Xa	VIP + PEX-Schaum	PE-HD	max. 95 °C / 10 bar	200	1119047	Kiwa System-zertifizierung DVGW, ÖVGW		
	50 x 6,9/140					200	1119048			
	63 x 8,6/140					200	1119049			
VIP Aqua Twin 	25 x 3,5-20 x 2,8/140	PE-Xa	VIP + PEX-Schaum	PE-HD	max. 95 °C / 10 bar	200	1119053	Kiwa System-zertifizierung DVGW, ÖVGW		
	32 x 4,4-20 x 2,8/140					200	1119054			
	40 x 5,5-25 x 3,5/140					200	1119055			
	50 x 6,9-32 x 4,4/175					200	1119056			
Aqua Single optional mit Heizkabel 	25 x 3,5/140	PE-Xa	PEX-Schaum	PE-HD	max. 95 °C / 10 bar	200	1018117	DVGW, ÖVGW		
	32 x 4,4/140					200	1018118			
	40 x 5,5/175					200	1018119			
	50 x 6,9/175					200	1018120			
	63 x 8,6/175					200	1018121			
Aqua Twin 	25 x 3,5-25 x 3,5/175	PE-Xa	PEX-Schaum	PE-HD	max. 95 °C / 10 bar	200	1018139	DVGW, ÖVGW		
	32 x 4,4-25 x 3,5/175					200	1018140			
	40 x 5,5-25 x 3,5/175					200	1018141			
	50 x 6,9-25 x 3,5/175					200	1018142			
Quattro 	2x25 x 2,3-2x25 x 3,5/175	PE-Xa + EVOH + PE-Xa	PEX-Schaum	PE-HD	max. 95 °C / 6 / 10 bar	200	1018147	DVGW, ÖVGW		
	2x32 x 2,9-2x25 x 3,5/175					200	1018148			
	2x32 x 2,9-32 x 4,4-25 x 3,5/175					200	1018149			
	2x40 x 3,7-32 x 4,4-20 x 2,8/200					100	1084891			
	2x40 x 3,7-40 x 5,5-25 x 3,5/200					100	1084890			
Supra 	25 x 2,3/68	PE 100-RC schwarz mit blauen Streifen	PEX-Schaum	PE-HD	20 °C / 16 bar	200	1095722	DVGW		
	32 x 2,9/68					200	1095723			
	40 x 3,7/140					200	1095724			
	50 x 4,6/140					200	1095725			
	63 x 5,8/140					200	1095726			
	75 x 6,8/175					100	1095727			
	90 x 8,2/175					100	1095728			
	110 x 10,0/200					100	1095729			
Supra PLUS cable Mit Frostschutzkabel 	25 x 2,3/68	PE 100-RC schwarz mit blauen Streifen	PEX-Schaum	PE-HD	20 °C / 16 bar	150	1095730	DVGW		
	32 x 2,9/68					150	1095731			
	40 x 3,7/140					150	1095734			
	50 x 4,6/140					150	1095736			
	63 x 5,8/140					150	1095737			
	75 x 6,8/175					150	1095738			
	90 x 8,2/200					100	1095739			
	110 x 10,0/200					100	1095740			



# Uponor Ecoflex Nahwärmeversorgung

Art-Nr.	Dimension	LE	VE	ME RG	Preis/ME
---------	-----------	----	----	----------	----------

## Uponor Ecoflex VIP Thermo

### Uponor Ecoflex VIP Thermo Single

 <b>1095714</b>	40X3,7/140	-	200	$\frac{m}{H7}$	<b>70,74</b>
<b>1095715</b>	50X4,6/140	-	200	$\frac{m}{H7}$	<b>87,82</b>
<b>1095716</b>	63X5,8/140	-	200	$\frac{m}{H7}$	<b>111,83</b>
<b>1095717</b>	75X6,8/140	-	200	$\frac{m}{H7}$	<b>141,07</b>
<b>1095718</b>	90X8,2/175	-	150	$\frac{m}{H7}$	<b>147,35</b>
<b>1095719</b>	110X10,0/175	-	150	$\frac{m}{H7}$	<b>164,02</b>
<b>1095720</b>	125X11,4/200	-	120	$\frac{m}{H7}$	<b>226,22</b>

### Uponor Ecoflex VIP Thermo Twin

 <b>1118580</b>	2x25x2,3/140	-	200	$\frac{m}{H7}$	<b>74,74</b>
<b>1118581</b>	2x32x2,9/140	-	200	$\frac{m}{H7}$	<b>87,28</b>
<b>1118582</b>	2x40x3,7 /175	-	200	$\frac{m}{H7}$	<b>107,04</b>
<b>1118583</b>	2x50x4,6/175	-	200	$\frac{m}{H7}$	<b>137,33</b>
<b>1118584</b>	2x63x5,8/200	-	100	$\frac{m}{H7}$	<b>161,22</b>
<b>1118585</b>	2x75x6,8/250	-	100	$\frac{m}{H7}$	<b>221,81</b>

## Uponor Ecoflex Thermo

### Uponor Ecoflex Thermo Single

 <b>1018109</b>	25x2,3/140	-	200	$\frac{m}{H1}$	<b>42,41</b>
<b>1018110</b>	32x2,9/140	-	200	$\frac{m}{H1}$	<b>52,08</b>
<b>1018111</b>	40x3,7/175	-	200	$\frac{m}{H1}$	<b>64,25</b>
<b>1018112</b>	50x4,6/175	-	200	$\frac{m}{H1}$	<b>79,86</b>
<b>1018113</b>	63x5,8/175	-	200	$\frac{m}{H1}$	<b>101,62</b>
<b>1018114</b>	75x6,8/200	-	100	$\frac{m}{H1}$	<b>124,85</b>
<b>1018115</b>	90x8,2/200	-	100	$\frac{m}{H1}$	<b>130,37</b>
<b>1018116</b>	110x10,0/200	-	100	$\frac{m}{H1}$	<b>145,16</b>

### Uponor Ecoflex Thermo Twin

 <b>1018134</b>	2x25x2,3/175	-	200	$\frac{m}{H1}$	<b>67,89</b>
<b>1018135</b>	2x32x2,9/175	-	200	$\frac{m}{H1}$	<b>79,36</b>
<b>1018136</b>	2x40x3,7 /175	-	200	$\frac{m}{H1}$	<b>97,33</b>
<b>1018137</b>	2x50x4,6/200	-	100	$\frac{m}{H1}$	<b>124,85</b>
<b>1018138</b>	2x63x5,8/200	-	100	$\frac{m}{H1}$	<b>146,52</b>

### Uponor Ecoflex Thermo Mini

 <b>1018132</b>	25x2,3/68	-	200	$\frac{m}{H1}$	<b>31,08</b>
<b>1018133</b>	32x2,9/68	-	200	$\frac{m}{H1}$	<b>38,54</b>

### Uponor Ecoflex Thermo Twin HP

 <b>1093894</b>	2x32x2,9-2x32x3,5/140	-	200	$\frac{m}{H1}$	<b>71,41</b>
<b>1093895</b>	2x40x3,7-2x32x3,5/175	-	200	$\frac{m}{H1}$	<b>92,46</b>

Art-Nr.	Dimension	LE	VE	ME RG	Preis/ME
---------	-----------	----	----	----------	----------

## Uponor Ecoflex Varia

### Uponor Ecoflex Varia Single

 <b>1018230</b>	25x2,3 /90	-	200	$\frac{m}{H6}$	<b>38,26</b>
<b>1018231</b>	32x2,9 /90	-	200	$\frac{m}{H6}$	<b>46,85</b>
<b>1018232</b>	40x3,7 /140	-	200	$\frac{m}{H6}$	<b>57,90</b>
<b>1018233</b>	50x4,6 /140	-	200	$\frac{m}{H6}$	<b>71,85</b>
<b>1018234</b>	63x5,8 /140	-	200	$\frac{m}{H6}$	<b>91,46</b>
<b>1018235</b>	75x6,8 /175	-	200	$\frac{m}{H6}$	<b>112,37</b>
<b>1018236</b>	90x8,2 /175	-	100	$\frac{m}{H6}$	<b>117,35</b>
<b>1018237</b>	110x10,0 /175	-	100	$\frac{m}{H6}$	<b>130,62</b>
<b>1062886</b>	125x11,4/200	-	120	$\frac{m}{H6}$	<b>197,54</b>

### Uponor Ecoflex Varia Twin

 <b>1018238</b>	2x25x2,3/140	-	200	$\frac{m}{H6}$	<b>61,09</b>
<b>1018239</b>	2x32x2,9/140	-	200	$\frac{m}{H6}$	<b>69,83</b>
<b>1018240</b>	2x40x3,7/140	-	200	$\frac{m}{H6}$	<b>87,61</b>
<b>1018241</b>	2x50x4,6/175	-	200	$\frac{m}{H6}$	<b>112,37</b>

# Uponor Ecoflex Nahwärmeversorgung

Art-Nr.	Dimension	LE	VE	ME RG	Preis/ME
---------	-----------	----	----	----------	----------

## Uponor Ecoflex VIP Aqua

### Uponor Ecoflex VIP Aqua Single

 <b>1119047</b>	40x5,5/140	-	200	$\frac{m}{H7}$	<b>103,03</b>
<b>1119048</b>	50x6,9/140	-	200	$\frac{m}{H7}$	<b>121,32</b>
<b>1119049</b>	63x8,6/140	-	200	$\frac{m}{H7}$	<b>153,49</b>

### Uponor Ecoflex VIP Aqua Twin

 <b>1119053</b>	25x3,5-20x2,8/140	-	200	$\frac{m}{H7}$	<b>78,49</b>
<b>1119054</b>	32x4,4-20x2,8/140	-	200	$\frac{m}{H7}$	<b>96,22</b>
<b>1119055</b>	40x5,5-25x3,5/140	-	200	$\frac{m}{H7}$	<b>114,51</b>
<b>1119056</b>	50x6,9-32x4,4/175	-	200	$\frac{m}{H7}$	<b>156,94</b>

## Uponor Ecoflex Aqua

### Uponor Ecoflex Aqua Single

 <b>1018117</b>	25x3,5/140	-	200	$\frac{m}{H1}$	<b>54,45</b>
<b>1018118</b>	32x4,4/140	-	200	$\frac{m}{H1}$	<b>59,49</b>
<b>1018119</b>	40x5,5/175	-	200	$\frac{m}{H1}$	<b>93,67</b>
<b>1018120</b>	50x6,9/175	-	200	$\frac{m}{H1}$	<b>110,25</b>
<b>1018121</b>	63x8,6/175	-	200	$\frac{m}{H1}$	<b>139,53</b>

### Uponor Ecoflex Aqua Twin

 <b>1018139</b>	25x3,5-25x3,5/175	-	200	$\frac{m}{H1}$	<b>71,35</b>
<b>1018140</b>	32x4,4-25x3,5/175	-	200	$\frac{m}{H1}$	<b>87,51</b>
<b>1018141</b>	40x5,5-25x3,5/175	-	200	$\frac{m}{H1}$	<b>104,10</b>
<b>1018142</b>	50x6,9-25x3,5/175	-	200	$\frac{m}{H1}$	<b>142,68</b>

Art-Nr.	Dimension	LE	VE	ME RG	Preis/ME
---------	-----------	----	----	----------	----------

## Uponor Ecoflex Quattro

### Uponor Ecoflex Quattro

 <b>1018147</b>	2x25x2,3-2x25x3,5/175	-	200	$\frac{m}{H1}$	<b>130,94</b>
<b>1018148</b>	2x32x2,9-2x25x3,5/175	-	200	$\frac{m}{H1}$	<b>146,28</b>
<b>1018149</b>	2x32x2,9-32x4,4-25x3,5/175	-	200	$\frac{m}{H1}$	<b>156,45</b>
<b>1084891</b>	2x40x3,7-32x4,4-20x2,8/200	-	100	$\frac{m}{H1}$	<b>164,26</b>
<b>1084890</b>	2x40x3,7-40x5,5-25x3,5/200	-	100	$\frac{m}{H1}$	<b>169,24</b>

Installation

Flächenheizung  
und -kühlungNahwärme-  
versorgung

Werkzeuge

Anhang

# Uponor Ecoflex Nahwärmeversorgung

Art-Nr.	Dimension	LE	VE	ME RG	Preis/ME
---------	-----------	----	----	----------	----------

## Uponor Ecoflex Supra

### Uponor Ecoflex Supra

 <b>1095722</b>	25x2,3/68	-	200	<sup>m</sup> <sub>H1</sub>	<b>27,55</b>
<b>1095723</b>	32x2,9/68	-	200	<sup>m</sup> <sub>H1</sub>	<b>32,15</b>
<b>1095724</b>	40x3,7/140	-	200	<sup>m</sup> <sub>H1</sub>	<b>42,41</b>
<b>1095725</b>	50x4,6/140	-	200	<sup>m</sup> <sub>H1</sub>	<b>47,03</b>
<b>1095726</b>	63x5,8/140	-	200	<sup>m</sup> <sub>H1</sub>	<b>48,71</b>
<b>1095727</b>	75x6,8/175	-	150	<sup>m</sup> <sub>H1</sub>	<b>58,66</b>
<b>1095728</b>	90x8,2/175	-	100	<sup>m</sup> <sub>H1</sub>	<b>61,83</b>
<b>1095729</b>	110x10,0/200	-	100	<sup>m</sup> <sub>H1</sub>	<b>83,01</b>

Art-Nr.	Dimension	LE	VE	ME RG	Preis/ME
---------	-----------	----	----	----------	----------

## Uponor Ecoflex Supra PLUS

### Uponor Ecoflex Supra PLUS cable

 <b>1095730</b>	25x2,3/68 1x10W/m	-	150	<sup>m</sup> <sub>H1</sub>	<b>55,22</b>
<b>1095731</b>	32x2,9/68 1x10W/m	-	150	<sup>m</sup> <sub>H1</sub>	<b>61,41</b>
<b>1095734</b>	40x3,7/140 1x10W/m	-	150	<sup>m</sup> <sub>H1</sub>	<b>72,43</b>
<b>1095736</b>	50x4,6/140 1x10W/m	-	150	<sup>m</sup> <sub>H1</sub>	<b>77,62</b>
<b>1095737</b>	63x5,8/140 1x10W/m	-	150	<sup>m</sup> <sub>H1</sub>	<b>80,66</b>
<b>1095738</b>	75x6,8/175 1x10W/m	-	150	<sup>m</sup> <sub>H1</sub>	<b>100,76</b>
<b>1095739</b>	90x8,2/200 1x10W/m	-	100	<sup>m</sup> <sub>H1</sub>	<b>134,23</b>
<b>1095740</b>	110x10,0/200 1x10W/m	-	100	<sup>m</sup> <sub>H1</sub>	<b>146,19</b>

### Uponor Ecoflex Supra PLUS Set

 <b>1120124</b>	25+32/68	-	1	Set H2	<b>443,27</b>
<b>1120126</b>	40+50+63/140	-	1	Set H2	<b>492,03</b>
<b>1120127</b>	75/175	-	1	Set H2	<b>569,32</b>
<b>1120128</b>	90+110/200	-	1	Set H2	<b>623,50</b>

### Uponor Ecoflex Supra PLUS Regler 150

 <b>1120123</b>			50	1	St. H2	<b>393,09</b>
--	--	--	----	---	-----------	---------------

### Uponor Ecoflex Supra PLUS Kabel-Set S1

 <b>1042310</b>				1	St. H2	<b>78,63</b>
--	--	--	--	---	-----------	--------------

### Uponor Ecoflex Supra PLUS Kabel-Set S2

 <b>1042311</b>				1	St. H2	<b>176,22</b>
--	--	--	--	---	-----------	---------------

### Uponor Ecoflex Supra PLUS T-Set

 <b>1061641</b>	140/90/68		5	1	St. H2	<b>637,08</b>
<b>1061642</b>	200/175/140		3	1	St. H2	<b>731,79</b>

### Uponor Ecoflex Reduzierring

 <b>1060991</b>	200/68		8	1	St. H2	<b>12,20</b>
--	--------	--	---	---	-----------	--------------

# Uponor Wipex

Art-Nr.	Dimension	LE	VE	ME RG	Preis/ME
<b>Uponor Wipex Übergangsnippel PN6</b>					
 <b>1018328</b>	25x2,3-G1	40	1	St. H5	<b>64,99</b>
<b>1018329</b>	32x2,9-G1	20	1	St. H5	<b>71,11</b>
<b>1018330</b>	40x3,7-G1 ¼	10	1	St. H5	<b>87,63</b>
<b>1018331</b>	50x4,6-G1 ¼	10	1	St. H5	<b>101,34</b>
<b>1018332</b>	63x5,8-G2	8	1	St. H5	<b>127,48</b>
<b>1018333</b>	75x6,8-G2	6	1	St. H5	<b>173,68</b>
<b>1018334</b>	90x8,2-G3	4	1	St. H5	<b>240,85</b>
<b>1018335</b>	110x10,0-G3	3	1	St. H5	<b>289,02</b>

## Uponor Ecoflex Übergangsnippel PN6

 <b>1078368</b>	125x11,4-R4	-	1	St. H5	<b>468,58</b>
--	-------------	---	---	-----------	---------------

## Uponor Wipex Übergangsnippel PN10

 <b>1091505</b>	20x2,8-¾"	10	1	St. H5	<b>61,45</b>
--	-----------	----	---	-----------	--------------

## Uponor Wipex Übergangsnippel PN10

 <b>1018336</b>	25x3,5-G1	40	1	St. H5	<b>67,15</b>
<b>1018338</b>	32x4,4-G1	20	1	St. H5	<b>74,60</b>
<b>1018339</b>	40x5,5-G1 ¼	10	1	St. H5	<b>92,56</b>
<b>1018340</b>	50x6,9-G1 ¼	10	1	St. H5	<b>101,46</b>
<b>1018341</b>	63x8,6-G2	8	1	St. H5	<b>127,02</b>

## Uponor Wipex Kupplung PN6

 <b>1042972</b>	25x2,3-25x2,3	30	1	St. H5	<b>129,35</b>
<b>1042973</b>	32x2,9-32x2,9	25	1	St. H5	<b>141,02</b>
<b>1042980</b>	40x3,7-40x3,7	15	1	St. H5	<b>166,39</b>
<b>1042984</b>	50x4,6-50x4,6	10	1	St. H5	<b>191,21</b>
<b>1042981</b>	63x5,8-63x5,8	5	1	St. H5	<b>240,87</b>
<b>1042985</b>	75x6,8-75x6,8	3	1	St. H5	<b>343,02</b>
<b>1042986</b>	90x8,2-90x8,2	4	1	St. H5	<b>470,05</b>
<b>1042987</b>	110x10-110x10	2	1	St. H5	<b>567,86</b>

## Uponor Ecoflex Kupplung PN6

 <b>1078365</b>	125x11,4-125x11,4	-	1	St. H5	<b>656,91</b>
--	-------------------	---	---	-----------	---------------

Art-Nr.	Dimension	LE	VE	ME RG	Preis/ME
<b>Uponor Wipex Kupplung PN10</b>					
 <b>1042970</b>	25x3,5-25x3,5	40	1	St. H5	<b>131,09</b>
<b>1042974</b>	32x4,4-32x4,4	25	1	St. H5	<b>143,79</b>
<b>1042979</b>	40x5,5-40x5,5	15	1	St. H5	<b>169,33</b>
<b>1042983</b>	50x6,9-50x6,9	10	1	St. H5	<b>194,15</b>
<b>1042982</b>	63x8,6-63x8,6	4	1	St. H5	<b>275,89</b>

## Uponor Wipex T-Stück

 <b>1018345</b>	G1-G1-G1	20	1	St. H5	<b>38,84</b>
<b>1018346</b>	G1 ¼-G1 ¼-G1 ¼	10	1	St. H5	<b>51,68</b>
<b>1018347</b>	G2-G2-G2	4	1	St. H5	<b>76,78</b>
<b>1018348</b>	G3-G3-G3	3	1	St. H5	<b>178,11</b>

## Uponor Ecoflex T-Stück

 <b>1078367</b>	Rp4-Rp4-Rp4	-	1	St. H5	<b>207,29</b>
--	-------------	---	---	-----------	---------------

## Uponor Wipex Winkel

 <b>1018350</b>	G1-G1	20	1	St. H5	<b>39,99</b>
<b>1018351</b>	G1 ¼-G1 ¼	15	1	St. H5	<b>42,55</b>
<b>1018352</b>	G2-G2	5	1	St. H5	<b>69,78</b>
<b>1018353</b>	G3-G3	2	1	St. H5	<b>151,79</b>

## Uponor Ecoflex Winkel

 <b>1078366</b>	Rp4-Rp4	-	1	St. H5	<b>205,80</b>
--	---------	---	---	-----------	---------------

## Uponor Wipex Gewindemuffe

 <b>1018355</b>	G1-G1	40	1	St. H5	<b>30,80</b>
<b>1018356</b>	G1 ¼-G1 ¼	25	1	St. H5	<b>37,51</b>
<b>1018357</b>	G2-G2	15	1	St. H5	<b>57,81</b>
<b>1018358</b>	G3-G3	10	1	St. H5	<b>95,17</b>



# Uponor Wipex

Art-Nr.	Dimension	LE	VE	ME RG	Preis/ME
 <b>1018368</b>	G1 ¼-G1	25	1	St. H5	<b>28,02</b>
<b>1018369</b>	G1 ½-G1 ¼	25	1	St. H5	<b>63,80</b>
<b>1018371</b>	G2-G1	15	1	St. H5	<b>90,07</b>
<b>1018372</b>	G2-G1 ¼	15	1	St. H5	<b>84,08</b>
<b>1018373</b>	G2 ½-G2	6	1	St. H5	<b>147,41</b>
<b>1018374</b>	G3-G1	6	1	St. H5	<b>147,44</b>
<b>1018375</b>	G3-G1 ¼	10	1	St. H5	<b>153,24</b>
<b>1018376</b>	G3-G2	10	1	St. H5	<b>154,69</b>
<b>1009052</b>	G4-G3	6	1	St. H5	<b>205,79</b>

## Uponor Ecoflex Reduzierung

 <b>1078369</b>	R4-G3	6	1	St. H5	<b>156,19</b>
--	-------	---	---	-----------	---------------

## Uponor Wipex Gewindeflansch

 <b>1018359</b>	F25/4-85/G1	10	1	St. H5	<b>178,06</b>
<b>1018360</b>	F32/4-100/G1 ¼	5	1	St. H5	<b>220,39</b>
<b>1018361</b>	F40/4-110/G1 ½	5	1	St. H5	<b>239,63</b>
<b>1018362</b>	F50/4-125/G2	4	1	St. H5	<b>332,82</b>
<b>1018363</b>	F65/8-145/2 ½	3	1	St. H5	<b>426,25</b>
<b>1018364</b>	F80/8-160/G3	3	1	St. H5	<b>452,54</b>
<b>1018365</b>	F100/8-180/G4	3	1	St. H5	<b>602,90</b>

## Uponor Ecoflex Gewindeflansch

 <b>1078370</b>	F100/8-180/Rp4	-	1	St. H5	<b>302,17</b>
--	----------------	---	---	-----------	---------------

## Uponor Wipex Drehnippel

 <b>1045455</b>	G1	20	1	St. H5	<b>81,03</b>
<b>1045456</b>	G1 ¼-G1	20	1	St. H5	<b>84,08</b>
<b>1045457</b>	G1 ¼	15	1	St. H5	<b>89,34</b>
<b>1065442</b>	G1¼ 120mm	8	1	St. H5	<b>118,85</b>
<b>1045458</b>	G2-G1 ¼	10	1	St. H5	<b>133,44</b>
<b>1045459</b>	G2	10	1	St. H5	<b>137,36</b>
<b>1065444</b>	G2 120mm	3	1	St. H5	<b>178,07</b>
<b>1045460</b>	G3-G2	3	1	St. H5	<b>271,47</b>
<b>1045461</b>	G3	2	1	St. H5	<b>459,85</b>

Art-Nr.	Dimension	LE	VE	ME RG	Preis/ME
 <b>1018302</b>	G1	30	1	St. H5	<b>76,20</b>
<b>1018303</b>	G1 ¼	10	1	St. H5	<b>96,79</b>
<b>1018304</b>	G2	5	1	St. H5	<b>156,16</b>
<b>1018305</b>	G3	5	1	St. H5	<b>294,90</b>

## Uponor Wipex Anschweißkupplung ST PN6

 <b>1094013</b>	EU+GOST 25x2,3-26,9	-	1	St. H5	<b>118,96</b>
<b>1094014</b>	EU 32x2,9-33,7	-	1	St. H5	<b>129,69</b>
<b>1094015</b>	EU 40x3,7-42,4	-	1	St. H5	<b>153,08</b>
<b>1094016</b>	EU 50x4,6-48,3	-	1	St. H5	<b>175,92</b>
<b>1094017</b>	EU 63x5,8-60,3	-	1	St. H5	<b>221,59</b>
<b>1094018</b>	EU+GOST 75x6,8-76,1	-	1	St. H5	<b>315,61</b>
<b>1094019</b>	EU+GOST 90x8,2-88,9	-	1	St. H5	<b>432,46</b>
<b>1094020</b>	EU 110x10,0-114,3	-	1	St. H5	<b>522,40</b>
<b>1094021</b>	EU+GOST 125x11,4-114,3	-	1	St. H5	<b>796,44</b>

## Uponor Wipex - MLC Presskupplung S-Press PN6

 <b>1060058</b>	32x2,9-32x3,0	25	1	St. H5	<b>107,88</b>
---	---------------	----	---	-----------	---------------

## Uponor Wipex - MLC Presskupplung S-Press PN6

 <b>1060059</b>	40x3,7-40x4,0	15	1	St. H5	<b>128,76</b>
<b>1060060</b>	50x4,6-50x4,5	10	1	St. H5	<b>185,39</b>

## Uponor Wipex RS Adapter PN6

 <b>1047013</b>	DR 63x5,8 RS2	240	1	St. H5	<b>126,87</b>
--	---------------	-----	---	-----------	---------------

## Uponor Wipex Aufsprezzange

 <b>1046407</b>	1 - 1 ½	25	1	St. NET	<b>39,78</b>
--	---------	----	---	------------	--------------

# Uponor Q&E

Art-Nr.	Dimension	LE	VE	ME RG	Preis/ME
---------	-----------	----	----	----------	----------

## Uponor Q&E Sicherungsring white

 <b>1057455</b>	25	300	20	St. F1	<b>1,28</b>
<b>1057456</b>	32	150	10	St. F1	<b>2,42</b>

## Uponor Q&E Ring natural

 <b>1045464</b>	40	80	5	St. H3	<b>3,82</b>
<b>1045489</b>	50	70	5	St. H3	<b>5,34</b>
<b>1045490</b>	63	35	5	St. H3	<b>8,41</b>
<b>1085087</b>	75	18	2	St. H3	<b>18,41</b>

## Uponor Q&E Winkel PPSU

 <b>1008681</b>	25-25	25	5	St. H3	<b>12,82</b>
<b>1001245</b>	32-32	10	1	St. H3	<b>25,63</b>
<b>1008683</b>	40-40	10	1	St. H3	<b>40,19</b>
<b>1042859</b>	50-50	5	1	St. H3	<b>64,18</b>
<b>1042858</b>	63-63	3	1	St. H3	<b>96,18</b>
<b>1085080</b>	75-75	2	1	St. H3	<b>153,30</b>

## Uponor Q&E Kupplung PPSU

 <b>1008671</b>	25-25	50	5	St. H3	<b>10,14</b>
<b>1001235</b>	32-32	15	1	St. H3	<b>15,72</b>
<b>1008673</b>	40-40	10	1	St. H3	<b>30,60</b>
<b>1042866</b>	50-50	10	1	St. H3	<b>45,87</b>
<b>1042865</b>	63-63	5	1	St. H3	<b>79,60</b>
<b>1085084</b>	75-75	10	1	St. H3	<b>153,30</b>

## Uponor Q&E Reduzierkupplung PPSU

 <b>1001240</b>	32-25	20	1	St. H3	<b>23,73</b>
<b>1008678</b>	40-32	10	1	St. H3	<b>30,60</b>
<b>1042879</b>	50-32	10	1	St. H3	<b>45,87</b>
<b>1042867</b>	50-40	10	1	St. H3	<b>45,87</b>
<b>1042878</b>	63-40	5	1	St. H3	<b>78,69</b>
<b>1042877</b>	63-50	5	1	St. H3	<b>76,52</b>
<b>1085086</b>	75-50	10	1	St. H3	<b>152,84</b>
<b>1085085</b>	75-63	10	1	St. H3	<b>153,30</b>

## Uponor Q&E T-Stück PPSU

 <b>1008686</b>	25-25-25	20	5	St. H3	<b>16,16</b>
<b>1001250</b>	32-32-32	10	1	St. H3	<b>32,87</b>
<b>1008688</b>	40-40-40	5	1	St. H3	<b>53,59</b>
<b>1042861</b>	50-50-50	3	1	St. H3	<b>91,72</b>
<b>1042860</b>	63-63-63	2	1	St. H3	<b>122,37</b>
<b>1085081</b>	75-75-75	2	1	St. H3	<b>183,95</b>

Art-Nr.	Dimension	LE	VE	ME RG	Preis/ME
---------	-----------	----	----	----------	----------

## Uponor Q&E Reduzier-T-Stück PPSU

 <b>1008712</b>	25-32-25	15	1	St. H3	<b>32,87</b>
<b>1001426</b>	32-25-25	15	1	St. H3	<b>32,87</b>
<b>1001428</b>	32-25-32	15	1	St. H3	<b>32,87</b>
<b>1008713</b>	32-40-32	10	1	St. H3	<b>59,50</b>
<b>1008708</b>	40-25-32	5	1	St. H3	<b>59,50</b>
<b>1008695</b>	40-25-40	5	1	St. H3	<b>59,50</b>
<b>1008709</b>	40-32-32	5	1	St. H3	<b>59,50</b>
<b>1008696</b>	40-32-40	5	1	St. H3	<b>59,50</b>
<b>1042876</b>	50-25-40	4	1	St. H3	<b>91,72</b>
<b>1042864</b>	50-25-50	4	1	St. H3	<b>91,72</b>
<b>1042863</b>	50-32-50	4	1	St. H3	<b>91,72</b>
<b>1042862</b>	50-40-40	4	1	St. H3	<b>91,72</b>
<b>1042875</b>	50-40-50	4	1	St. H3	<b>91,72</b>
<b>1042871</b>	63-25-50	2	1	St. H3	<b>127,81</b>
<b>1042873</b>	63-25-63	2	1	St. H3	<b>127,81</b>
<b>1042870</b>	63-32-63	2	1	St. H3	<b>127,81</b>
<b>1042869</b>	63-40-40	2	1	St. H3	<b>127,81</b>
<b>1042872</b>	63-40-63	2	1	St. H3	<b>127,81</b>
<b>1042868</b>	63-50-50	2	1	St. H3	<b>127,81</b>
<b>1042874</b>	63-50-63	2	1	St. H3	<b>127,81</b>
<b>1085083</b>	75-25-75	4	1	St. H3	<b>183,39</b>
<b>1085082</b>	75-40-75	4	1	St. H3	<b>183,39</b>

## Uponor Q&E Übergangsnippel PL

 <b>1023007</b>	25-R $\frac{3}{4}$ "MT	70	5	St. H3	<b>22,93</b>
<b>1047191</b>	32-R1"MT	10	1	St. H3	<b>38,26</b>

## Uponor Q&E Übergangsnippel PL/DR

 <b>1085077</b>	40-R1 $\frac{1}{4}$ "MT	16	1	St. H3	<b>61,20</b>
<b>1085076</b>	50-R1 $\frac{1}{2}$ "MT	8	1	St. H3	<b>76,52</b>
<b>1085075</b>	63-R2"MT	6	1	St. H3	<b>114,66</b>
<b>1085074</b>	75-R2 $\frac{1}{2}$ "MT	6	1	St. H3	<b>222,60</b>

## Uponor Q&E Winkel mit Innengewinde PL

 <b>1023026</b>	25-G $\frac{3}{4}$ "FT	35	5	St. H3	<b>22,93</b>
--	------------------------	----	---	-----------	--------------

## Uponor Q&E Übergangsmuffe PL

 <b>1023012</b>	25-Rp $\frac{3}{4}$ "FT	40	5	St. H3	<b>22,93</b>
--	-------------------------	----	---	-----------	--------------

# Uponor Ecoflex Systemzubehör

Art-Nr.	Dimension	LE	VE	ME RG	Preis/ME
---------	-----------	----	----	----------	----------

## Uponor Ecoflex Gummi-Endkappe, Single

 <b>1018316</b>	25+32+40/68	-	1	St. H2	<b>30,70</b>
<b>1018246</b>	25+32+40/90	-	1	St. H2	<b>37,14</b>
<b>1018315</b>	25+28+32/140	-	1	St. H2	<b>39,57</b>
<b>1018313</b>	32+40+50/175	-	1	St. H2	<b>53,68</b>
<b>1018314</b>	40+50+63/140	-	1	St. H2	<b>44,61</b>
<b>1095801</b>	63+75+90/140	-	1	St. H2	<b>51,68</b>
<b>1018312</b>	63+75/175	-	1	St. H2	<b>58,15</b>
<b>1018310</b>	75+90+110/200	-	1	St. H2	<b>76,59</b>
<b>1018311</b>	90+110/175	-	1	St. H2	<b>74,14</b>
<b>1067757</b>	125/200	-	1	St. H2	<b>91,77</b>

## Uponor Ecoflex Gummi-Endkappe, Twin

 <b>1119374</b>	18-22+25-28+32/140	-	1	St. H2	<b>54,95</b>
<b>1018245</b>	25+32+40/140	-	1	St. H2	<b>63,03</b>
<b>1018309</b>	25+32+40/175	-	1	St. H2	<b>77,54</b>
<b>1018308</b>	25+32+50/175	-	1	St. H2	<b>80,25</b>
<b>1018307</b>	40+50+63/200	-	1	St. H2	<b>82,81</b>
<b>1088979</b>	75+90/250	-	1	St. H2	<b>102,61</b>

## Uponor Ecoflex Gummi-Endkappe, Quattro

 <b>1086838</b>	20+25+32/140	-	1	St. H2	<b>93,26</b>
<b>1018306</b>	18-22+25-28+32/175	-	1	St. H2	<b>93,26</b>
<b>1094252</b>	25-28+32+40/175	-	1	St. H2	<b>100,57</b>
<b>1034308</b>	18-28+32+40/200	-	1	St. H2	<b>142,31</b>

## Uponor Ecoflex T-Isoliersatz

 <b>1060986</b>	140/90/68	5	1	St. H2	<b>430,08</b>
<b>1060982</b>	200/175/140	4	1	St. H2	<b>506,95</b>
<b>NEU</b> <b>1121805</b>	250/200/175/140	3	1	St. H2	<b>981,38</b>

## Uponor Ecoflex Eckisoliersatz

 <b>1060985</b>	200/175/140	3	1	St. H2	<b>396,78</b>
--	-------------	---	---	-----------	---------------

Art-Nr.	Dimension	LE	VE	ME RG	Preis/ME
---------	-----------	----	----	----------	----------

## Uponor Ecoflex Längsisoliersatz

 <b>1060984</b>	200/175/140	6	1	St. H2	<b>393,08</b>
<b>NEU</b> <b>1121806</b>	250	4	1	St. H2	<b>497,01</b>

## Uponor Ecoflex Reduzierring

 <b>1060991</b>	200/68	8	1	St. H2	<b>12,20</b>
<b>1060990</b>	200/90	8	1	St. H2	<b>17,55</b>
<b>1085107</b>	200/160	12	1	St. H2	<b>16,94</b>
<b>NEU</b> <b>1121807</b>	250/250	-	1	St. H2	<b>19,95</b>
<b>NEU</b> <b>1121808</b>	250/200	-	1	St. H2	<b>19,95</b>
<b>NEU</b> <b>1121809</b>	250/175	-	1	St. H2	<b>19,95</b>
<b>NEU</b> <b>1122070</b>	250/140	-	1	St. H2	<b>19,95</b>

## Uponor Ecoflex H-Isoliersatz

 <b>1007355</b>	200/175/140	-	1	St. H2	<b>853,87</b>
--	-------------	---	---	-----------	---------------

## Uponor Ecoflex Schacht

 <b>1018326</b>	6x140/145/175/200	-	3	St. H2	<b>1287,69</b>
<b>1018327</b>	8x140/145/175/200	-	3	St. H2	<b>1368,78</b>
<b>1084576</b>	2x250-6x140/175/200	-	1	St. H2	<b>1857,08</b>
<b>1084577</b>	4x250-4x140/175/200	-	1	St. H2	<b>2843,45</b>
<b>1084578</b>	6x250-2x140/175/200	-	1	St. H2	<b>3293,89</b>

## Uponor Ecoflex Dichtband

 <b>1018382</b>	50mm x 10m	-	1	St. H2	<b>121,04</b>
--	------------	---	---	-----------	---------------

## Uponor Ecoflex Schrumpfschlauch

 <b>1018379</b>	140	-	1	St. H2	<b>39,71</b>
<b>1018380</b>	175/200	-	1	St. H2	<b>44,46</b>
<b>1084575</b>	250	15	1	St. H2	<b>83,76</b>

## Uponor Ecoflex Hauseinführungsbogen Single

 <b>1118765</b>	50x4,6/140	-	1	St. H2	<b>543,00</b>
<b>1118766</b>	63x5,8/140	-	1	St. H2	<b>569,18</b>
<b>1118767</b>	75x6,8/140	-	1	St. H2	<b>955,15</b>

Lieferzeit auf Anfrage.

# Uponor Ecoflex Systemzubehör

Art-Nr.	Dimension	LE	VE	ME RG	Preis/ME
 1118771	2x25x2,3/140	-	1	St. H2	497,21
1118772	2x32x2,9/140	-	1	St. H2	523,38
1118773	2x40x3,7/160	-	1	St. H2	614,97
1118774	2x50x4,6/200	-	1	St. H2	754,20
1118775	2x63x5,8/200	-	1	St. H2	955,15
1118776	2x75x6,8/250	-	1	St. H2	1282,28

Lieferzeit auf Anfrage.

## Uponor Ecoflex Reduzierring

 1085107	200/160	12	1	St. H2	16,94
---	---------	----	---	-----------	-------

## Uponor Ecoflex Mauerdurchführung DWD

 1007358	68	-	1	St. H2	272,43
1007359	90	-	1	St. H2	315,81
1007360	140	-	1	St. H2	359,19
1007361	175	-	1	St. H2	466,28
1007362	200	-	1	St. H2	600,51
1091429	250	-	1	St. H2	675,03

## Uponor Ecoflex Ergänzungssatz NDW

 1007365	140	-	1	St. H2	211,44
1007366	175	-	1	St. H2	256,15
1007367	200	-	1	St. H2	379,55
1091430	250	-	1	St. H2	458,13

## Uponor Ecoflex Faserzementrohr DWD

 1007368	68	-	1	St. H2	193,83
1007370	140	-	1	St. H2	199,26
1007371	175	-	1	St. H2	227,72
1007372	200	-	1	St. H2	313,10
1091431	250	-	1	St. H2	376,83

## Uponor Ecoflex Epoxidharz Set für DWD

 1007373	1,1 kg/3,5m <sup>2</sup>	-	1	Set H2	140,95
---	--------------------------	---	---	-----------	--------

## Uponor Ecoflex Mauerdurchführung NDW

 1018267	68+90	-	1	St. H2	53,13
1018269	140	-	1	St. H2	58,55
1018268	175+200	-	1	St. H2	64,78
1083871	250	16	1	St. H2	113,61

## Uponor Ecoflex Labyrinthdichtung NDW

 1034202	140	40	1	St. H2	64,78
1034203	175	30	1	St. H2	68,05
1034204	200	20	1	St. H2	78,04
1090415	250	-	1	St. H2	104,10

## Uponor Ecoflex Schrumpfmanschette

 1036014	140+175+200-700mm	-	1	St. H2	346,98
---	-------------------	---	---	-----------	--------

## Uponor Ecoflex Schrumpfband

 1093120	160mm x 10m	30	1	St. H2	159,28
---	-------------	----	---	-----------	--------

## Uponor Ecoflex Trassenwarnband, rot

 1018385	40mm x 250m	-	1	St. H2	62,49
1105785	40mm x 30m	-	1	St. H2	22,25

## Uponor Ecoflex Abroller type1

 1036645	< 650kg	-	1	St. NET	2260,90
---	---------	---	---	------------	---------

## Uponor Ecoflex Stationäre Abrollvorrichtung



 1119057	< 600kg	-	1	St. NET	3727,30
---	---------	---	---	------------	---------

Lieferzeit auf Anfrage.

## Uponor Multi Rohrschneider

 1089677	32-40	12	1	St. NET	96,79
1089779	32-40	50	1	St. NET	46,70

## Uponor Flex Rohrschneider PEX

  1095265	50-63	12	1	St. NET	117,71
 1095266	50+63 Ersatzklinge	50	1	St. NET	56,23

Lieferung solange Vorrat reicht. Artikel läuft im Laufe des Jahres aus.

# Uponor Ecoflex Systemzubehör

Art-Nr.	Dimension	LE	VE	ME RG	Preis/ME
---------	-----------	----	----	----------	----------

## Uponor Multi Rohrschneider

 <b>1089675</b>	25-63	12	1	St. NET	<b>92,31</b>
<b>1089777</b>	25-63	50	1	St. NET	<b>10,65</b>

## Uponor Multi Rohrschneider

 <b>1089676</b>	50-125	8	1	St. NET	<b>172,38</b>
<b>1089778</b>	50-125	50	1	St. NET	<b>13,25</b>

## Uponor MLC Universalentgrater

 <b>1060167</b>		50	1	St. NET	<b>19,69</b>
--	--	----	---	------------	--------------

## Uponor Wipex Aufsprezzange

 <b>1046407</b>	1 - 1 ½	25	1	St. NET	<b>39,78</b>
--	---------	----	---	------------	--------------

## Uponor Q&E Grafitpaste

 <b>1005017</b>	100g	-	1	St. NET	<b>29,59</b>
--	------	---	---	------------	--------------

Art-Nr.	Dimension	LE	VE	ME RG	Preis/ME
---------	-----------	----	----	----------	----------

## Uponor Ecoflex Dichtpaste

 <b>1060996</b>	290ml	-	1	St. H2	<b>24,33</b>
--	-------	---	---	-----------	--------------

## Uponor Ecoflex Spreiznieten

 <b>1021997</b>		-	1	St. H2	<b>0,32</b>
--	--	---	---	-----------	-------------

## Uponor Ecoflex Schrauben-Set

 <b>1021999</b>		-	1	St. H2	<b>1,09</b>
--	--	---	---	-----------	-------------

## Uponor Ecoflex Schrauben-Set

 <b>1060995</b>	M6x30 (34pcs)	-	1	St. H2	<b>20,24</b>
--	---------------	---	---	-----------	--------------

## Uponor Ecoflex Supra PLUS Frostschutzkabel

 <b>1044136</b>	10W/m	-	1	m H2	<b>23,11</b>
--	-------	---	---	---------	--------------

# Uponor Ecoflex Mietwerkzeuge

## Uponor RNT Ecoflex Aufweitwerkzeug rent DACH Q&E

 <b>1087649</b>	M18 6BAR 25/32/40	-	1	St. NET	Miet-Tarif B
--	-------------------	---	---	------------	-----------------

## Uponor RNT Ecoflex Aufweitwerkzeug rent DACH Q&E

 <b>1087650</b>	M18 10BAR 25/32	-	1	St. NET	Miet-Tarif B
--	-----------------	---	---	------------	-----------------

## Uponor RNT Ecoflex Aufweitwerkzeug rent DACH Q&E

 <b>1087651</b>	M18 VLD 40-75	-	1	St. NET	Miet-Tarif A
--	---------------	---	---	------------	-----------------

## Uponor RNT Ecoflex Abroller rent DACH

 <b>1087652</b>	type 1	-	1	St. NET	Miet-Tarif A
--	--------	---	---	------------	-----------------

## Uponor Ecoflex Rundungswerkz. rent DACH

 <b>1085661</b>	125	-	1	St. NET	Miet-Tarif C
--	-----	---	---	------------	-----------------

## Miet-Tarife für Uponor Ecoflex Mietwerkzeuge

- Unkomplizierter Verleih von Uponor Ecoflex Werkzeugen
- Einfache Anforderung mit dem Mietservice-Auftragsformular

Miet-Tarif Gruppe	Tagesmiete		
	3-9 Tage	ab dem 10. Tag	ab dem 30. Tag
A	17,50 €	12,00 €	9,00 €
B	15,30 €	9,40 €	7,80 €
C	9,90 €	8,30 €	5,50 €

Falls Sie die Uponor Montagewerkzeuge kaufen möchten, wenden Sie sich bitte an unseren für Sie zuständigen Außendienstmitarbeiter.

# Werkzeuge

Art-Nr.	Dimension	LE	VE	ME RG	Preis/ME
---------	-----------	----	----	----------	----------

## Abrollen

### Uponor MLC Rohrrichter



1010512	14-25	60	1	St. NET	563,32
---------	-------	----	---	------------	--------

### Uponor Multi Teleskop-Abrollvorrichtung



1058662		-	1	St. NET	541,58
---------	--	---	---	------------	--------

### Uponor Multi Abrollvorrichtung



1006255	120-960M	-	1	St. NET	669,94
---------	----------	---	---	------------	--------

### Uponor Magna Abrollvorrichtung



1006256	25-640m	-	1	St. NET	1265,43
---------	---------	---	---	------------	---------

### Uponor Magna Abrollvorrichtung



<b>NEU</b> 1135500		21	1	St. NET	428,90
--------------------	--	----	---	------------	--------

Art-Nr.	Dimension	LE	VE	ME RG	Preis/ME
---------	-----------	----	----	----------	----------

## Vorbereitung, Schneiden, Biegen

### Uponor Multi Rohrschneider



1089674	12-25	36	1	St. NET	106,57
1089776	12-25 Ersatzklinge	150	1	St. NET	23,22

### Uponor Multi Rohrschneider



1089677	32-40	12	1	St. NET	96,79
1089779	32-40 Ersatzklinge	50	1	St. NET	46,70

### Uponor Flex Rohrschneider PEX



<b>OUT</b> 1095265	50-63	12	1	St. NET	117,71
<b>OUT</b> 1095266	50+63 Ersatzklinge	50	1	St. NET	56,23

Lieferung solange Vorrat reicht. Artikel läuft im Laufe des Jahres aus.

### Uponor Multi Rohrschneider



1089675	25-63	12	1	St. NET	92,31
1089777	25-63 Ersatzschneidrad	50	1	St. NET	10,65

### Uponor Multi Rohrschneider



1089676	50-125	8	1	St. NET	172,38
1089778	50-125 Ersatzschneidrad	50	1	St. NET	13,25

### Uponor Flex Rohrschneider PEX



1089673	12-25	36	1	St. NET	34,20
1089780	12-25 Ersatzklinge	150	1	St. NET	23,22

### Uponor MLC Ersatzschneidrad



1006635	25-63 Ersatzschneidrad	1000	1	St. NET	10,65
1014173	50-110 Ersatzschneidrad	20	1	St. NET	12,82

### Uponor MLC Rohrabschneider und Entgrater



1014334	63-110	32	1	St. NET	760,16
1014320	63-110 Ersatzschneidrad	100	1	St. U2	93,45

Installation

Flächenheizung  
und -kühlungNahwärme-  
versorgung

Werkzeuge

Anhang

# Werkzeuge

Art-Nr.	Dimension	LE	VE	ME RG	Preis/ME
---------	-----------	----	----	----------	----------

## Vorbereitung, Schneiden, Biegen

### Uponor MLC Entgrater

	<b>1006952</b>	14	50	1	St. NET	<b>35,28</b>
	<b>1006830</b>	16	50	1	St. NET	<b>37,07</b>
	<b>1015749</b>	20	1200	1	St. NET	<b>40,60</b>
	<b>1015756</b>	25	960	1	St. NET	<b>42,90</b>
	<b>1015762</b>	32	900	1	St. NET	<b>46,70</b>

### Uponor MLC Entgrater

	<b>1006638</b>	40	600	1	St. NET	<b>48,05</b>
	<b>1015808</b>	50	600	1	St. NET	<b>57,01</b>
	<b>1014339</b>	63	600	1	St. NET	<b>69,88</b>
	<b>1014344</b>	75	600	1	St. NET	<b>103,57</b>

### Uponor MLC Kombientgrater

	<b>1015739</b>	16/20/25	60	1	St. NET	<b>64,61</b>
---	----------------	----------	----	---	------------	--------------

### Uponor MLC Universalentgrater

	<b>1060167</b>		50	1	St. NET	<b>19,69</b>
---	----------------	--	----	---	------------	--------------

Art-Nr.	Dimension	LE	VE	ME RG	Preis/ME
---------	-----------	----	----	----------	----------

### Uponor MLC Biegefeder innen

	<b>1013727</b>	14	1000	1	St. NET	<b>14,04</b>
	<b>1013729</b>	16	100	1	St. NET	<b>14,93</b>
	<b>1013734</b>	20	75	1	St. NET	<b>19,01</b>
	<b>1013737</b>	25	50	1	St. NET	<b>19,35</b>
	<b>1013739</b>	32	40	1	St. NET	<b>29,19</b>

### Uponor MLC Biegefeder außen

	<b>1006639</b>	14	550	1	St. NET	<b>17,31</b>
	<b>1006640</b>	16	55	1	St. NET	<b>18,72</b>
	<b>1013792</b>	20	45	1	St. NET	<b>23,83</b>
	<b>1013794</b>	25	45	1	St. NET	<b>24,36</b>

### Uponor Uni Pipe PLUS Biegeange

	<b>1071925</b>	16-32	100	1	St. NET	<b>561,97</b>
---	----------------	-------	-----	---	------------	---------------

### Uponor Uni Pipe PLUS Biegesegment

	<b>1120408</b>	R32 16	10	1	St. NET	<b>113,00</b>
	<b>1120409</b>	R40 20	10	1	St. NET	<b>113,00</b>
	<b>1120410</b>	R62,5 25	10	1	St. NET	<b>113,00</b>
	<b>1120411</b>	R80 32	10	1	St. NET	<b>259,89</b>

### Uponor RTM Kombikalibrierer

	<b>1048606</b>	16/20/25	20	1	St. NET	<b>7,32</b>
---	----------------	----------	----	---	------------	-------------



# Werkzeuge

Art-Nr.	Dimension	LE	VE	ME RG	Preis/ME
---------	-----------	----	----	----------	----------

## Pressen

### Uponor S-Press Handzange (ohne Wechseleinsätze)

 <b>1015764</b>	14-20	100	1	St. NET	<b>447,12</b>
--	-------	-----	---	------------	---------------

### Uponor S-Press Wechseleinsätze

 <b>1015776</b>	14	400	1	St. NET	<b>69,78</b>
<b>1015777</b>	16	50	1	St. NET	<b>69,78</b>
<b>1015780</b>	20	50	1	St. NET	<b>69,78</b>

### Uponor S-Press Akkumaschine UP 110 (ohne Pressbacken)



<b>1083612</b>		20	1	Set NET	<b>2239,60</b>
----------------	--	----	---	------------	----------------

### Uponor S-Press Ersatzakku UP 110

 <b>1083608</b>		10	1	St. NET	<b>392,31</b>
--	--	----	---	------------	---------------

### Uponor S-Press Ersatzladegerät

 <b>1083610</b>	Mini2, UP110	72	1	St. NET	<b>344,77</b>
--	--------------	----	---	------------	---------------

### Uponor S-Press Werkzeugkoffer UP110

 <b>1083602</b>		20	1	St. NET	<b>217,16</b>
--	--	----	---	------------	---------------

Art-Nr.	Dimension	LE	VE	ME RG	Preis/ME
---------	-----------	----	----	----------	----------

### Uponor S-Press Maschine UP75 EL (ohne Pressbacken)



<b>1007082</b>		20	1	St. NET	<b>1466,04</b>
----------------	--	----	---	------------	----------------

### Uponor S-Press Werkzeugkoffer blau UP 75



<b>1084676</b>		20	1	St. NET	<b>253,84</b>
----------------	--	----	---	------------	---------------

### Uponor S-Press Ersatzakku UP 75



<b>1006949</b>		12	1	St. NET	<b>241,62</b>
----------------	--	----	---	------------	---------------

### Uponor S-Press Ersatzladegerät UP 75



<b>1006950</b>		10	1	St. NET	<b>247,51</b>
----------------	--	----	---	------------	---------------

### Uponor S-Press Pressbacken UPP1



<b>1007083</b>	14	280	1	St. NET	<b>180,50</b>
<b>1007084</b>	16	216	1	St. NET	<b>180,50</b>
<b>1007086</b>	20	-	1	St. NET	<b>180,50</b>
<b>1007087</b>	25	-	1	St. NET	<b>180,50</b>
<b>1007088</b>	32	-	1	St. NET	<b>180,50</b>

### Uponor S-Press Pressbacken UPP1



<b>1015768</b>	40	108	1	St. NET	<b>232,09</b>
<b>1015792</b>	50	108	1	St. NET	<b>241,62</b>

### Uponor S-Press Basispressbacke



<b>1046545</b>	63-110	-	1	St. NET	<b>525,43</b>
----------------	--------	---	---	------------	---------------

### Uponor S-Press Pressschlinge



<b>1046541</b>	63	72	1	St. NET	<b>892,66</b>
<b>1046542</b>	75	72	1	St. NET	<b>1087,29</b>
<b>1046543</b>	90	72	1	St. NET	<b>1438,84</b>
<b>1046544</b>	110	54	1	St. NET	<b>1533,87</b>

# Werkzeuge

Art-Nr.	Dimension	LE	VE	ME RG	Preis/ME
---------	-----------	----	----	----------	----------

## Pressen

### Uponor S-Press Akkumaschine Mini<sup>2</sup> mit KSP0 Pressbacken



1083586	16/20/25/32	30	1	Set NET	2212,29
---------	-------------	----	---	------------	---------

### Uponor S-Press Akkumaschine Mini<sup>2</sup> mit KSP0 Pressbacken



1083594	16/20/25	25	1	Set NET	2009,08
---------	----------	----	---	------------	---------

Art-Nr.	Dimension	LE	VE	ME RG	Preis/ME
---------	-----------	----	----	----------	----------

### Uponor S-Press Akkumaschine Mini<sup>2</sup> (ohne Pressbacken)



1087260		-	1	St. NET	1072,21
---------	--	---	---	------------	---------

### Uponor S-Press Ersatzakku Mini<sup>2</sup>



1083605		48	1	St. NET	328,50
---------	--	----	---	------------	--------

### Uponor S-Press Ersatzladegerät



1083610	Mini2, UP110	72	1	St. NET	344,77
---------	--------------	----	---	------------	--------

### Uponor S-Press Ersatzakku Mini



1015703		120	1	St. NET	243,00
---------	--	-----	---	------------	--------

### Uponor S-Press Werkzeugkoffer Mini<sup>2</sup>



1083599		25	1	St. NET	115,39
---------	--	----	---	------------	--------

### Uponor S-Press Pressbacken Mini KSP0



1007090	14	5	1	St. NET	210,38
1007091	16	5	1	St. NET	210,38
1007093	20	5	1	St. NET	210,38
1007094	25	5	1	St. NET	210,38
1007095	32	5	1	St. NET	210,38

# Werkzeuge

Art-Nr.	Dimension	LE	VE	ME RG	Preis/ME
---------	-----------	----	----	----------	----------

## Aufweiten

### Uponor Minitec Aufweitwerkzeug



1006247	9,9x1,1	11	1	Set NET	390,93
---------	---------	----	---	------------	--------

### Uponor Q&E Aufweitwerkzeug mit Aufweitk. M12



<b>OUT</b>	1063112	6BAR 9,9/20	-	1	Set NET	661,08
<b>OUT</b>	1057166	16/20/25 6bar	-	1	Set NET	840,40

Lieferung solange Vorrat reicht. Artikel läuft im Laufe des Jahres aus.

### Uponor Q&E Aufweitwerkzeug mit Aufweitk. M12/



1119375	6bar 9,9RS/20	-	1	Set NET	687,02
1119376	16RS/20/25 6bar	-	1	Set NET	828,25

### Uponor Q&E Aufweitkopf M12/Rapid Seal



1119380	9,9x1.1	-	1	St. NET	141,25
---------	---------	---	---	------------	--------

### Uponor Q&E Aufweitkopf M12/M18



	1057184	14/15x2,5	-	1	St. NET	153,35
<b>OUT</b>	1057172	16x1,8/2,0/2,2	-	1	St. NET	147,95
	1057185	17/18x2,5	-	1	St. NET	147,95
<b>OUT</b>	1057173	20x1,9/2,0	-	1	St. NET	147,95
<b>OUT</b>	1057174	20x2,8	-	1	St. NET	147,95
<b>OUT</b>	1057175	25x2,3	-	1	St. NET	147,95
<b>OUT</b>	1057176	25x3,5	-	1	St. NET	147,95
<b>OUT</b>	1057177	32x2,9	-	1	St. NET	147,95

Lieferung solange Vorrat reicht. Artikel läuft im Laufe des Jahres aus.

### Uponor Q&E Aufweitkopf M12/M18/Rapid Seal



1119381	16x1,8/2,0/2,2	-	1	St. NET	141,25
1119382	20x1,9/2,0	-	1	St. NET	141,25
1119383	20x2,8	-	1	St. NET	141,25
1119384	25x2,3	-	1	St. NET	141,25
1119385	25x3,5	-	1	St. NET	141,25
1119386	32x2,9	-	1	St. NET	141,25

### Uponor Q&E Ersatzakku für Aufweitwerkz. M12



1061185	4Ah	12	1	St. NET	147,95
---------	-----	----	---	------------	--------

Art-Nr.	Dimension	LE	VE	ME RG	Preis/ME
---------	-----------	----	----	----------	----------

### Uponor Q&E Aufweitwerkzeug mit Aufweitk. M18 6bar



1063908	16/20/25/32	-	1	Set NET	1467,81
---------	-------------	---	---	------------	---------

### Uponor Q&E Aufweitwerkzeug mit Aufweitk. M18 10bar



1063909	16/20/25/H32	-	1	Set NET	1549,51
---------	--------------	---	---	------------	---------

### Uponor Q&E Aufweitkopf M18 H



1057182	32x2,9/4,4	-	1	St. NET	164,25
1057183	40x3,7	-	1	St. NET	164,25

### Uponor Q&E Aufweitwerkzeug M18 VLD PEX



1085099	40-75	-	1	St. NET	3333,36
---------	-------	---	---	------------	---------

### Uponor Q&E Aufweitkopf VLD



1085095	40x3,7/5,5	-	1	St. NET	647,39
1085096	50x4,6/6,9	-	1	St. NET	662,43
1085097	63x5,8/8,6	-	1	St. NET	698,89
1085098	75x6,8/10,3	-	1	St. NET	747,17

### Uponor Q&E Akku für Aufweitwerkzeug M18 PEX



1085100	5,0Ah	-	1	St. NET	350,23
---------	-------	---	---	------------	--------

### Uponor Q&E Ladegerät Aufweitwerkzeug M12/M18 PEX



1085101	220-240V/50-60Hz	-	1	St. NET	163,40
---------	------------------	---	---	------------	--------

### Uponor Q&E Grafitpaste



1005017	100g	-	1	St. NET	29,59
---------	------	---	---	------------	-------

Installation

Flächenheizung  
und -kühlungNahwärme-  
versorgung

Werkzeuge

Anhang

# Werkzeuge

Art-Nr.	Dimension	LE	VE	ME RG	Preis/ME
---------	-----------	----	----	----------	----------

## Befestigen

### Uponor Multi Rohrhalterung



<b>1088066</b>		-	1	St. NET	<b>293,79</b>
----------------	--	---	---	------------	---------------

### Uponor Siccus 14 Schneidegerät



<b>1006290</b>	14mm 230V	20	1	St. NET	<b>272,85</b>
----------------	-----------	----	---	------------	---------------

### Uponor Tacker Werkzeug



<b>1119039</b>	14-20mm	50	1	St. NET	<b>274,65</b>
----------------	---------	----	---	------------	---------------

### Uponor Multi Klebebandabroller



<b>1000142</b>		20	1	St. NET	<b>30,97</b>
----------------	--	----	---	------------	--------------

### Uponor Classic Clipmaster



<b>1006295</b>	16/17mm l=920mm	100	1	St. NET	<b>248,59</b>
<b>1006309</b>	20mm l=920mm	-	1	St. NET	<b>378,88</b>

### Uponor Classic Ersatzteilerfeder



<b>1007349</b>		-	1	St. U1	<b>10,73</b>
----------------	--	---	---	-----------	--------------

### Uponor Classic Drillgerät f.Mattenbinder



<b>1006243</b>	l=320mm	50	1	St. NET	<b>26,19</b>
----------------	---------	----	---	------------	--------------

Art-Nr.	Dimension	LE	VE	ME RG	Preis/ME
---------	-----------	----	----	----------	----------

## Sonstige

### Uponor Rapex Press-Backe



<b>1006330</b>	14x2	-	1	St. NET	<b>248,59</b>
<b>1006332</b>	16x2	8	1	St. NET	<b>248,59</b>
<b>1006343</b>	17x2	-	1	St. NET	<b>248,59</b>
<b>1006334</b>	20x2,3	-	1	St. NET	<b>265,54</b>
<b>1006344</b>	25x2,3	-	1	St. NET	<b>265,54</b>

### Uponor Smart Aqua Biegezange f. Schiene



<b>1015424</b>	2m	100	1	St. NET	<b>169,65</b>
----------------	----	-----	---	------------	---------------

# Allgemeine Liefer- und Zahlungsbedingungen der Uponor GmbH

## 1. Allgemeines

- 1.1 Unsere Lieferungen und Leistungen erfolgen ausschließlich aufgrund der nachstehenden Bedingungen. Abweichungen haben nur dann Gültigkeit, wenn sie schriftlich von uns bestätigt werden.
- 1.2 Mit der Erteilung des Auftrages, spätestens mit der Entgegennahme der Ware erkennt der Käufer unsere Allgemeinen Liefer- und Zahlungsbedingungen an. Abweichende Bedingungen des Käufers, die wir nicht ausdrücklich schriftlich anerkennen, sind für uns unverbindlich, auch wenn wir ihnen nicht ausdrücklich widersprechen.
- 1.3 Diese Bedingungen gelten auch für zukünftige Lieferungen aufgrund schriftlicher oder fernmündlicher Bestellungen des Käufers.
- 1.4 Alle Bestellungen, Aufträge und Vereinbarungen werden für uns erst mit Zugang unserer schriftlichen Auftragsbestätigung beim Käufer oder, falls eine Auftragsbestätigung nicht erteilt wird, mit Lieferung der Ware verbindlich. Mündliche oder telefonische Zusagen oder sonstige Abreden einschließlich etwaiger Ergänzungen, Abänderungen und Nebenabreden zu bereits angenommenen Bestellungen sowie durch unsere Vertreter getätigte Verkäufe sind für uns erst verbindlich, sobald und soweit sie von uns nachträglich schriftlich bestätigt sind.
- 1.5 Für Maschinen und Werkzeugverkäufe gelten ergänzend unsere diesbezüglichen Zusatzbedingungen.

## 2. Preise und Lieferung

- 2.1 Unsere Listen- und Angebotspreise sind freibleibend und unverbindlich, sofern nicht eine bestimmte Geltungsdauer schriftlich vereinbart ist. Alle Preise verstehen sich in EURO ab Werk ohne Verpackung, Verladung, Fracht und Montage zuzüglich der jeweils geltenden Mehrwertsteuer. Bei einer Direkt-/ Streckenlieferung mit einem Warenbestellwert unter 500 € netto wird ein Mindermengenzuschlag von 20 € zzgl. gesetzlicher Mehrwertsteuer pro Lieferung berechnet. Bei Lieferungen an das Lager des Käufers erfolgt die Lieferung grundsätzlich in vollständigen Verpackungseinheiten gemäß der aktuellen Preisliste. Müssen wir für die Bearbeitung einer Bestellung eine oder mehrere Verpackungseinheiten anbrechen, weil der Käufer lediglich eine anteilige Verpackungseinheit eines oder mehrerer Artikel bestellt hat, werden dem Käufer für diesen Mehraufwand pro Bestellung pauschal 20 € zzgl. gesetzlicher Mehrwertsteuer zusätzlich berechnet.
- 2.2 Unabhängig davon, ob eine Versendung ab Werk erfolgt und wer die Frachtkosten trägt, hat der Käufer alle Gefahren des Verlustes oder der Beschädigung der Ware von dem Zeitpunkt an zu tragen, zu dem ihm die Ware – ohne Verladung auf das abholende Beförderungsmittel – ab Werk zur Verfügung gestellt wurde.
- 2.3 Etwa notwendige Verpackung wird zum Selbstkostenpreis berechnet und nicht zurückgenommen.
- 2.4 Alle Liefertermine und Fristen gelten nur als annähernd, sofern sie nicht schriftlich ausdrücklich als verbindlich zugesagt werden. Wünscht der Käufer Lieferung zu einem späteren als dem ursprünglich vereinbarten Termin, können wir die Vertragsleistung zum vereinbarten Liefertermin in Rechnung stellen und die Ware auf Kosten des Käufers einlagern. Erfolgt eine Lagerung in unserem Werk, sind wir berechtigt, ein Lagergeld in Höhe von 2,5‰ des Auftragsnettowerts für jeden angefangenen Monat der Lagerung zu verlangen.
- 2.5 Teillieferungen sind zulässig.
- 2.6 Bestellt der Käufer Ware auf Abruf, so gilt der Abruf spätestens sechs Monate nach der Bestellung als erfolgt, es sei denn, es ist schriftlich eine andere Vereinbarung getroffen worden.
- 2.7 Betriebsstörungen, Kriegszustand, Arbeitskämpfe oder sonstige Ereignisse höherer Gewalt bei uns oder unseren Lieferanten berechtigen uns, die Lieferung um die betreffende Zeitdauer hinauszuschieben. Wir werden dem Käufer solche Hindernisse unverzüglich mitteilen. Erhöhen sich infolge derartiger unvorhergesehener Umstände unsere Kosten, so sind wir zu entsprechenden Preiskorrekturen berechtigt, insbesondere zur Berechnung der Tagespreise am Versandtag.

- 2.8 Begründete Zweifel an der Kreditwürdigkeit des Käufers berechtigen uns, vom Käufer für unsere Lieferungen Sicherheit oder Vorkasse zu verlangen oder vom Vertrag zurückzutreten. Schadensersatzansprüche des Käufers sind in diesen Fällen ausgeschlossen.

## 3. Zahlungsbedingungen

- 3.1 Zahlungstermine und Zahlungsfristen werden gesondert vereinbart. Bei Zielüberschreitungen werden bankübliche Zinsen, mindestens aber die gesetzlichen Verzugszinsen berechnet.
- 3.2 Die Annahme von Wechseln und Schecks erfolgt stets zahlungshalber; erst die Einlösung gilt als Zahlung. Die Annahme von Wechseln bedarf der gesonderten Vereinbarung. Diskontspesen und Kosten gehen zu Lasten des Kunden.
- 3.3 Unsere Angestellten, Vertreter oder Vertriebspartner sind nicht zur Entgegennahme von Zahlungen für uns berechtigt. Ausnahmen bedürfen unserer ausdrücklichen schriftlichen Einwilligung.
- 3.4 Mit von uns nicht anerkannten oder nicht rechtskräftig festgestellten Gegenansprüchen kann der Käufer weder aufrechnen noch wegen dieser Ansprüche ein Zurückbehaltungsrecht geltend machen.
- 3.5 Hält der Käufer die Zahlungsbedingungen nicht ein oder treten berechtigte Zweifel an der Kreditwürdigkeit des Käufers auf, so werden alle unsere Forderungen aus der gesamten Lieferbeziehung zum Käufer sofort fällig.

## 4. Eigentumsvorbehalt

- 4.1 Die gelieferten Waren bleiben bis zur vollständigen Bezahlung sämtlicher Lieferungen nebst allen Nebenforderungen aus der gesamten Geschäftsbeziehung einschließlich der Einlösung etwa von uns in Zahlung genommener Schecks oder Wechsel unser Eigentum. Unsere Forderungen gehen nicht durch Aufnahme in einen kontokorrentmäßigen Saldo und dessen Anerkennung unter.
- 4.2 Der Käufer hat die Vorbehaltsware ausreichend zu kennzeichnen und sie angemessen gegen Feuer und Einbruch-Diebstahl zu versichern.
- 4.3 Eine etwaige Be- oder Verarbeitung der Vorbehaltsware nimmt der Käufer für uns vor, ohne dass uns daraus Verpflichtungen entstehen. Bei Verarbeitung oder Verbindung der Vorbehaltsware mit anderen, nicht uns gehörenden Waren steht uns das dabei entstehende Miteigentum an der neuen Sache zu, und zwar im Verhältnis des Wertes der Vorbehaltsware zu der übrigen verarbeiteten Ware im Zeitpunkt der Verarbeitung oder Verbindung. Erwirbt der Käufer das Alleineigentum an der neuen Sache, so räumt er uns im Verhältnis des Wertes der verarbeiteten bzw. verbundenen Vorbehaltsware zum Gesamtwert der neuen Sache Miteigentum an der neuen Sache ein und verwahrt sie unentgeltlich für uns.
- 4.4 Der Käufer ist zur Weiterveräußerung der Vorbehaltsware im normalen Geschäftsverkehr berechtigt. Eine Verpfändung, Sicherungsübereignung oder ein Verleih ist ihm jedoch nicht gestattet. Veräußert der Käufer Vorbehaltsware weiter, so tritt er uns bereits jetzt seine künftigen Forderungen aus der Weiterveräußerung gegen seine Kunden mit allen Nebenrechten – einschließlich etwaiger Saldoforderungen – sicherungshalber ab, ohne dass es noch späterer besonderer Erklärungen bedarf. Wir nehmen die Abtretung an.
- 4.5 Wird die Vorbehaltsware von dem Käufer mit Grundstücken verbunden, so tritt der Käufer schon jetzt die daraus entstehende Forderung auf Vergütung in Höhe des Wertes der Vorbehaltsware mit allen Nebenrechten einschließlich des Rechts auf Einräumung einer Sicherungshypothek ab. Die Abtretung hat Vorrang vor sonstigen dem Käufer gegenüber seinem Kunden etwa zustehenden Ansprüchen. Wir nehmen die Abtretung an.
- 4.6 Wird die Vorbehaltsware zusammen mit anderen Waren – gleich ob ohne oder nach Verarbeitung oder Verbindung – weiterveräußert, so tritt der Käufer seine Forderungen aus der Weiterveräußerung der Vorbehaltsware ebenfalls an uns ab, jedoch nur in Höhe des Wertes der Vorbehaltsware, die zusammen mit den anderen Waren Gegenstand des Verkaufs ist. Entsprechendes gilt für etwaige Saldoforderungen. Wir nehmen die Abtretung an.

- 4.7 Bis auf Widerruf ist der Käufer zur Einziehung der abgetretenen Forderungen befugt. Wir sind zum Widerruf dieser Einziehungsbefugnis berechtigt, wenn der Käufer seinen Verpflichtungen uns gegenüber nicht nachkommt oder sonstige wichtige Gründe vorliegen, insbesondere Zahlungseinstellung, Eröffnung eines Insolvenzverfahrens, Wechselprotest oder vergleichbare Anhaltspunkte, die eine Zahlungsunfähigkeit des Käufers nahelegen. Im Falle des Widerrufs hat der Käufer uns die zur Einziehung unserer Forderungen erforderlichen Angaben über die abgetretenen Forderungen zu machen und den Schuldnern die Abtretung mitzuteilen.
- 4.8 Übersteigt der realisierbare Wert der uns nach Maßgabe der vorstehenden Ziffern zur Verfügung gestellten Sicherheiten die zu sichernden Forderungen aus der gesamten Geschäftsbeziehung um mehr als 20 %, sind wir auf Verlangen des Käufers insoweit zur Freigabe von Sicherheiten nach eigener Wahl verpflichtet.
- 4.9 Über das etwaige Abhandenkommen sowie die Beschädigung oder Zerstörung von Vorbehaltsware hat uns der Käufer unverzüglich zu unterrichten. Dasselbe gilt für Zwangsvollstreckungsmaßnahmen Dritter in die Vorbehaltsware oder in die abgetretenen Forderungen. Der Käufer hat uns alle Informationen zur Verfügung zu stellen, die wir benötigen, um unsere Rechte Dritten gegenüber geltend zu machen.
- 4.10 Die Geltendmachung von Eigentumsvorbehaltsrechten durch uns gilt nicht als Rücktritt vom Vertrag.
5. Haftung für Mängel
- 5.1 Die in dieser Produktinformation oder sonstigen Prospekten, Werbematerialien, Beschreibungen usw. enthaltenen Angaben beruhen auf dem aktuellen Stand unserer Erkenntnisse und Erfahrungen. Anwendung, Verwendung und Verarbeitung erfolgen außerhalb unserer Kontrollmöglichkeiten. Alle Angaben sind deswegen nur als ungefähre Angaben und nicht als Beschaffenheitsangaben anzusehen. Sie begründen keine Beschaffenheits- oder Haltbarkeitsgarantie. Die Eignung unserer Produkte für den vorgesehenen Anwendungszweck ist durch den Käufer zu prüfen.
- 5.2 Der Käufer hat gelieferte Ware unverzüglich zu untersuchen. Offenkundige Mängel sind uns spätestens innerhalb von acht Tagen nach Empfang der Ware schriftlich mitzuteilen, andere Mängel unverzüglich nach ihrem Auftreten. Unsere Haftung für Mängel, die nicht rechtzeitig angezeigt worden sind, ist ausgeschlossen.
- 5.3 Nimmt der Käufer mangelhafte Ware an, obwohl er den Mangel kennt oder infolge grober Fahrlässigkeit nicht kennt, so stehen ihm Ansprüche und Rechte wegen dieser Mängel nur zu, wenn er sich diese bei der Annahme vorbehalten hat. Bei begründeten Beanstandungen bessern wir nach unserer Wahl die mangelhaften Liefergegenstände nach oder liefern Ersatz. Aus- und Einbaukosten sowie sonstige mit der Nacherfüllung verbundenen Kosten, insbesondere Transport-, Wege-, Arbeits- und Materialkosten, übernehmen wir nicht, wenn und soweit solche Kosten dadurch entstanden sind oder sich erhöht haben, daß der Besteller den Liefergegenstand eingebaut oder sonst verarbeitet hat, obwohl Mängel erkennbar waren.
- 5.4 Ansprüche wegen Mängel der Sache bestehen nicht bei nur unerheblicher Abweichung des Liefergegenstandes von der vereinbarten Beschaffenheit, einer unerheblichen Beeinträchtigung der Brauchbarkeit, im Falle natürlicher Abnutzung, Beschädigung durch Gewalt, durch unsachgemäße Behandlung oder Verwendung, übermäßige Beanspruchung, elementare Einflüsse oder im Falle eigenmächtiger, selbst vorgenommener oder bei Dritten veranlaßter Eingriffe des Käufers an der Ware.
- 5.5 Alle Ansprüche wegen Mängel der Sache verjähren in zwölf Monaten ab Lieferung. Abweichend davon gilt für Mängel an Liefergegenständen, die entsprechend ihrer üblichen Verwendungsweise für ein Bauwerk verwendet worden sind und dessen Mangelhaftigkeit verursacht haben, die gesetzliche Verjährungsfrist.
- 5.6 Für Schadensersatz wegen Mängel der Sache haften wir ausschließlich im Rahmen der nachstehenden Ziffer 6.
- 5.7 Ansprüche des Käufers aus weitergehenden Erklärungen, die wir ausdrücklich und schriftlich im Zusammenhang mit Lieferungen abgegeben haben, bleiben von den vorstehenden Bestimmungen unberührt.
6. Haftung für Schadensersatzansprüche
- 6.1 Wir haften nicht für Verzögerungsschäden und für Schäden, die auf einer leicht fahrlässigen Pflichtverletzung oder Handlung beruhen. Dies gilt nicht, wenn die Pflichtverletzung oder Handlung zu einer Verletzung des Lebens, des Körpers oder der Gesundheit führt oder in der Verletzung wesentlicher vertraglicher Pflichten besteht.
- 6.2 Wir haften nicht für leicht fahrlässiges Handeln unserer Organe und/oder leitender Angestellter und nicht für leicht und/oder grob fahrlässiges Handeln nicht leitender Angestellter, sofern keine den Vertragszweck gefährdenden wesentlichen Pflichten verletzt werden und die Pflichtverletzung nicht zu einer Verletzung des Lebens, des Körpers oder der Gesundheit führt.
- 6.3 Unsere Haftung ist in allen Fällen begrenzt auf die bei Vertragsabschluss vorhersehbaren, typischen Schäden, die aus der Pflichtverletzung oder Handlung resultieren.
- 6.4 Mit der vorstehenden Regelung ist eine Änderung der Beweislast zum Nachteil des Käufers nicht verbunden.
- 6.5 Ansprüche des Käufers aus sonstigen Erklärungen, die wir ausdrücklich und schriftlich im Zusammenhang mit Lieferungen abgegeben haben, sowie zwingende gesetzliche Ansprüche des Käufers, insbesondere nach Maßgabe des Produkthaftpflichtgesetzes, bleiben unberührt.
7. Gerichtsstand
- Gerichtsstand ist für beide Teile Haßfurt, sofern der Käufer Kaufmann, juristische Person des öffentlichen Rechts oder öffentlich-rechtliches Sondervermögen ist. Das gilt auch für Scheck- und Wechselprozesse. Wir sind darüber hinaus berechtigt, den Käufer an seinem allgemeinen Gerichtsstand zu verklagen.
8. Schlussbestimmungen
- 8.1 Es gilt ausschließlich deutsches Recht mit Ausnahme der Regeln über das internationale Privatrecht und des UN-Abkommens über den internationalen Warenkauf (CISG).
- 8.2 Wir sind berechtigt, die uns im Rahmen der Geschäftsbeziehung oder im Zusammenhang mit ihr zugänglich gemachten Daten über den Käufer im Sinne des Bundesdatenschutzgesetzes zu verarbeiten.
- 8.3 Falls einzelne Bestimmungen dieser Allgemeinen Liefer- und Zahlungsbedingungen unwirksam sind oder werden sollten, wird die Wirksamkeit der übrigen Bestimmungen dadurch nicht berührt.
- 8.4 Durch diese Allgemeinen Liefer- und Zahlungsbedingungen werden alle früher geltenden Geschäftsbedingungen aufgehoben und ersetzt.

## Online verfügbare Versionen zum Download:



Uponor Preisliste Deutschland 2023



Online Produktkatalog



Uponor Downloadcenter



→ Uponor Videoanleitungen in YouTube:



HANDWERKERTIPPS für Installationsprofis

Klicken Sie doch mal rein!



- **Auszug aus dem umfangreichen Programm als Kurzpreisliste Deutschland 2023. Das vollständige Uponor Portfolio ist online als Gesamtpreisliste verfügbar.**
- Alle Preise sind unverbindliche Preisempfehlungen in Euro zzgl. der gültigen Mehrwertsteuer.
- Die angegebenen Werkzeugpreise sind Nettopreise.
- Es gelten unsere Verkaufs- und Lieferbedingungen.
- Nachstehende Preise verstehen sich ab Werk ausschließlich Transportverpackung.
- Technische und inhaltliche Änderungen behalten wir uns vor.
- Mehr Infos unter [www.uponor.de](http://www.uponor.de)

Alle rechtlichen und technischen Informationen wurden nach bestem Wissen sorgfältig zusammengestellt. Fehler können dennoch nicht vollständig ausgeschlossen und hierfür keine Haftung übernommen werden. Das Werk ist einschließlich aller seiner Teile urheberrechtlich geschützt. Jede Verwertung außerhalb der durch das Urhebergesetz zugelassenen Ausnahmen ist ohne Zustimmung der Uponor GmbH nicht gestattet. Insbesondere Vervielfältigungen, der Nachdruck, Bearbeitungen, Speicherung und Verarbeitung in elektronischen Systemen, Übersetzungen und Mikroverfilmungen behalten wir uns vor. Technische Änderungen vorbehalten.



**Moving**  
**➤ Forward**

**Uponor Kundenservice\* +49 (0)32 221 090 866**

**TECHNISCHE HOTLINE - VERTRIEB - ANGEBOTE - PROJEKTIERUNG**

\* Anruf aus dem Mobilnetz max. 9 ct./Min.

**uponor**

**Uponor GmbH**  
Industriestraße 56  
97437 Haßfurt  
[www.uponor.com](http://www.uponor.com)

**E-Mail:** [kundenservice@uponor.com](mailto:kundenservice@uponor.com)

1137620\_01/2023\_MaC\_Änderungen vorbehalten.